



Taiwan Excellent Auto Engine Parts
Warranty for

2 Year / 20,000 km

MITSUBISHI FUSO

Diesel Engine Parts

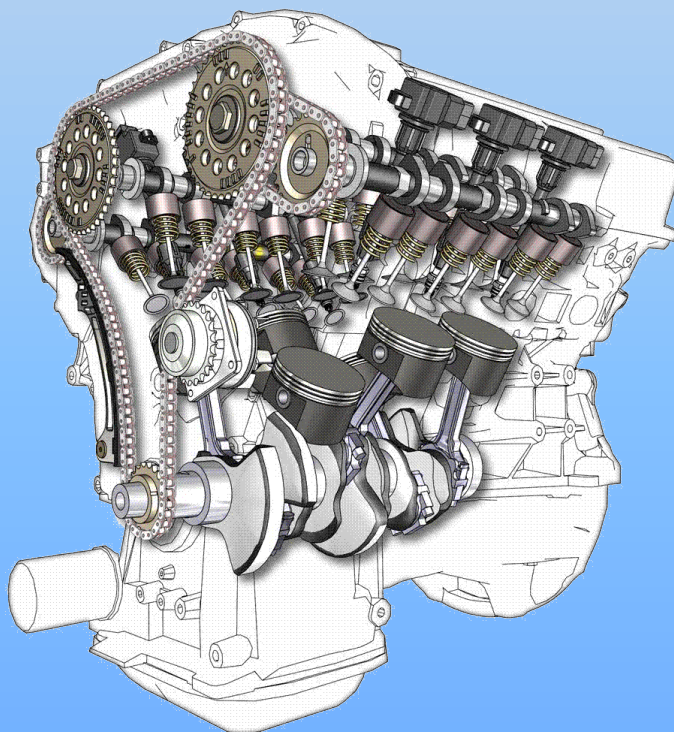

Contact Person: Mr. Jacky Tsai
Email 1: eton.jacky@msa.hinet.net
Email 2: valveparts2866@gmail.com
Tel : (8864) 2293-6969
Fax : (8864) 2293-7070
No. 90, Wenchang 1st St., North District,
Taichung City, Taiwan. 40464

E & T SCIENCE INC.

ISO/TS 16949
QS9000



PISTON TERMINOLOGY

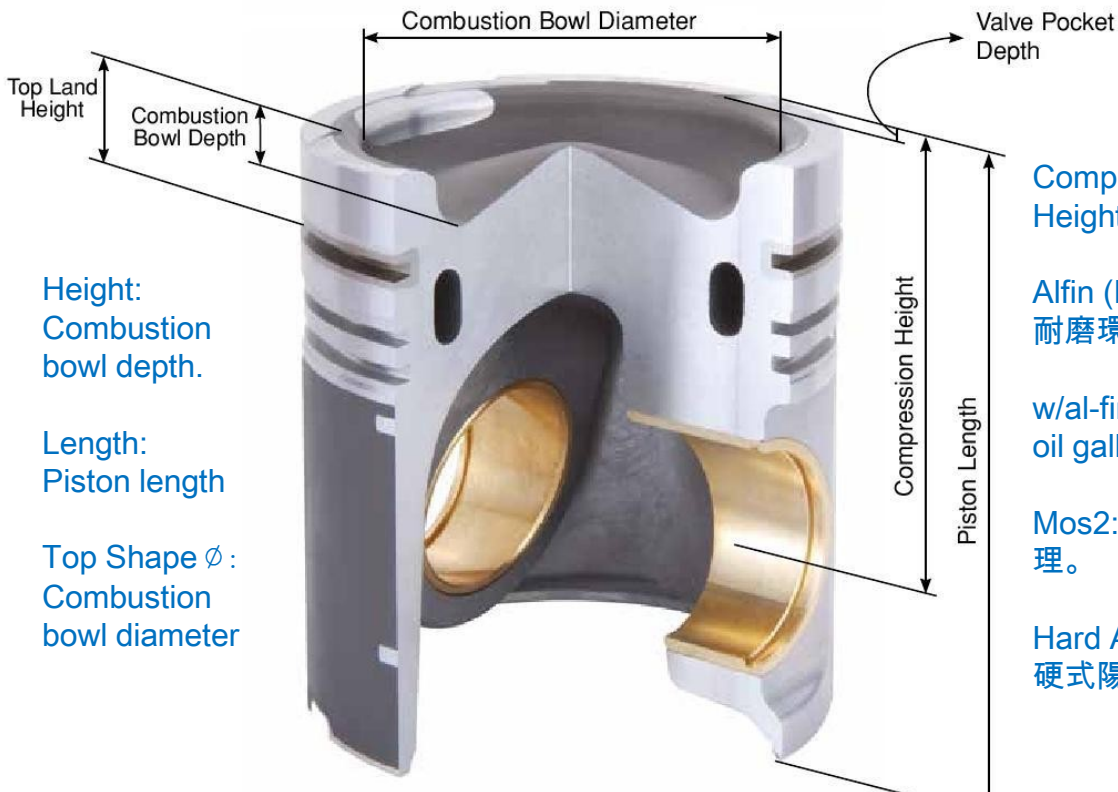
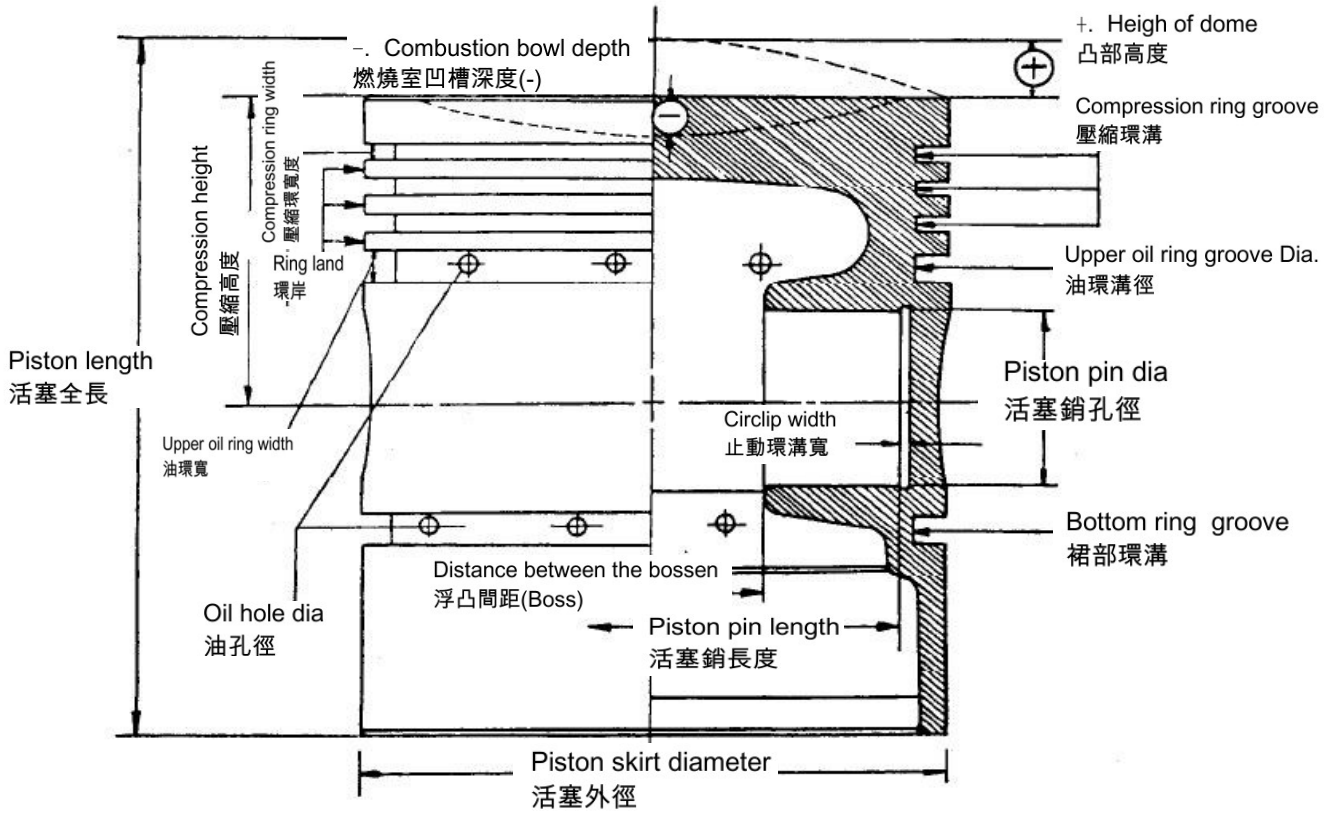



PISTON RING TERMINOLOGY

Free Ring(Unstressed)

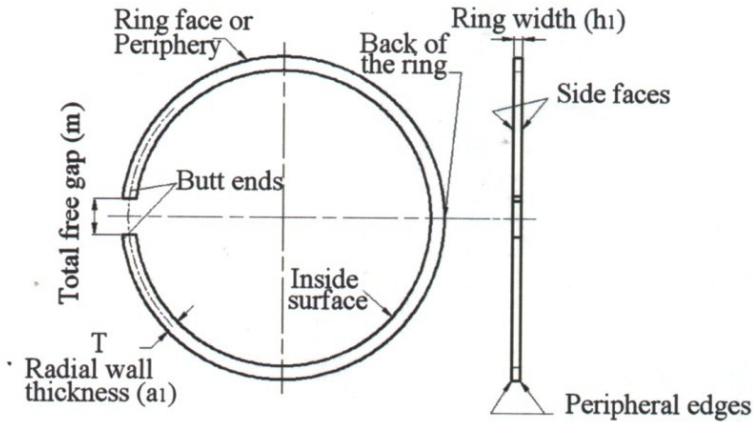

Closed Ring

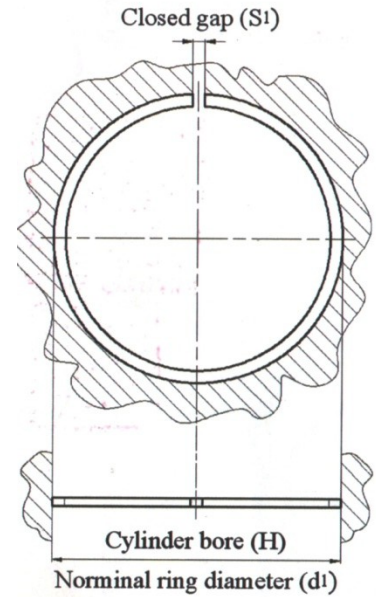

Compression Ring

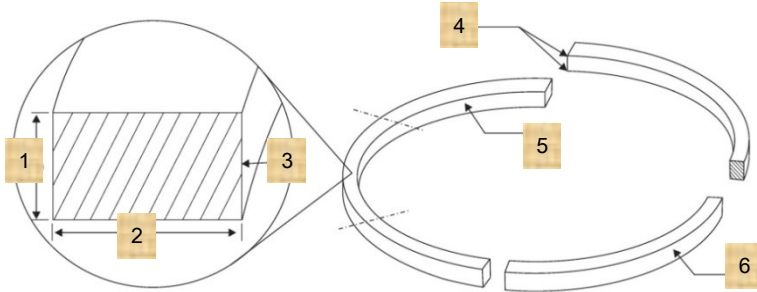

- 1. Piston ring width
- 2. Piston ring thickness
- 3. Inside edge of gap
- 4. Inside edges
- 5. Inside surface
- 6. Peripheral surface

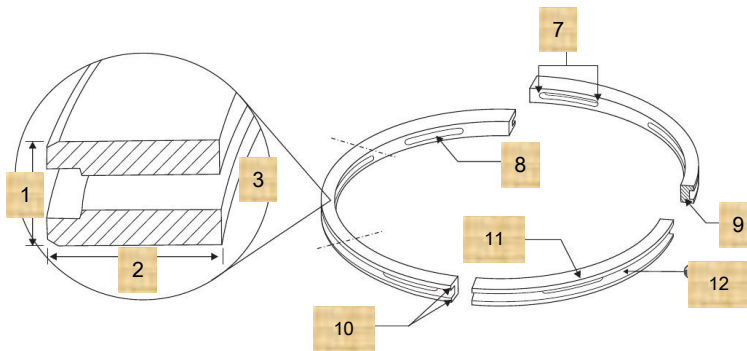

- 7. Inside edges of slot
- 8. Slot face
- 9. Gap face
- 10. Outside gap corners
- 11. Side face
- 12. Outside groove face

Oil Control Ring



LINER/SLEEVE TERMINOLOGY

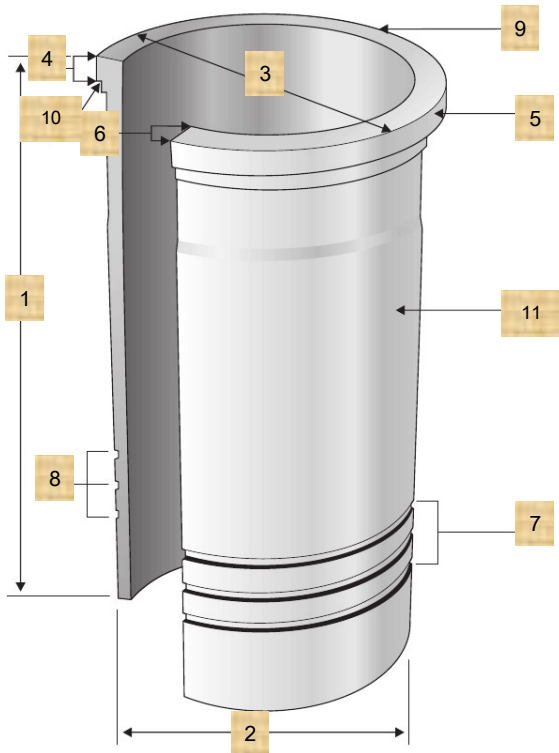

- 1. Total length
- 2. Outside diameter
- 3. Flange diameter
(Register diameter)
- 4. Flange depth
(Collar height)
- 5. Flange
- 6. Top land width
- 7. Sealing area
- 8. O-Ring groove
- 9. Firewall
- 10. Machining relief
- 11. Barel



Wet Cylinder Liner

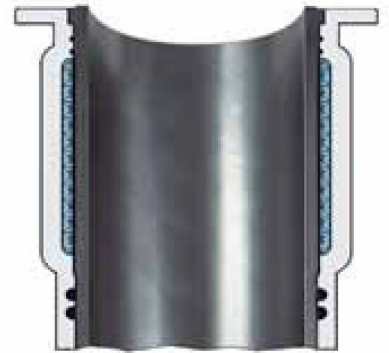

Dry Cylinder Liner

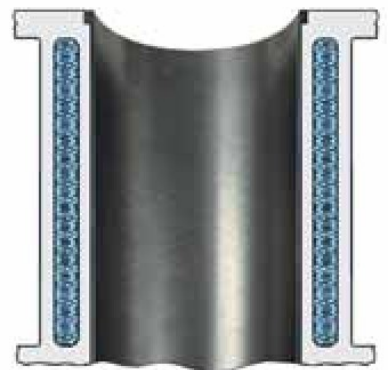



BEARINGS TERMINOLOGY



Rocker arm bushes



Con rod bushes



Connecting rod bearing



Main bearing



Flanged bearing



Thrust washers



Camshaft bearing

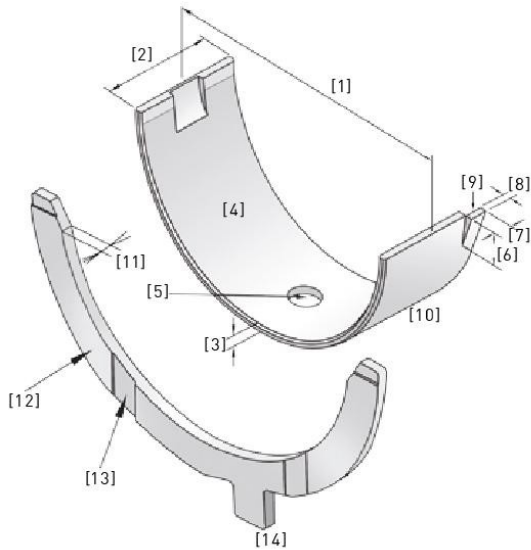

Bearing Shell

1. Free spread
2. Bearing length
3. Bearing wall thickness
4. Bearing surface
5. Lubrication hole
6. Length of locating lug
7. Width of locating lug
8. Height of locating lug
9. Locating lug relief
10. Bearing back

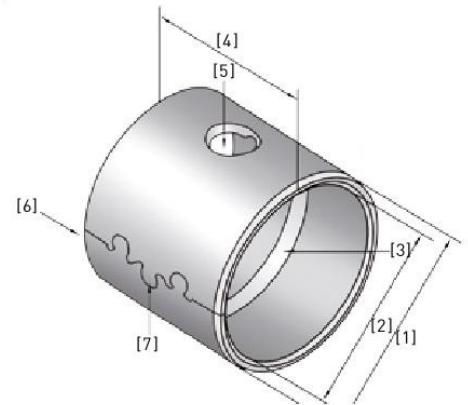

Bushing

1. Outside diameter
2. Inside diameter
3. Oil groove
4. Bushing length
5. Lubrication hole
6. Joint
7. Clinch

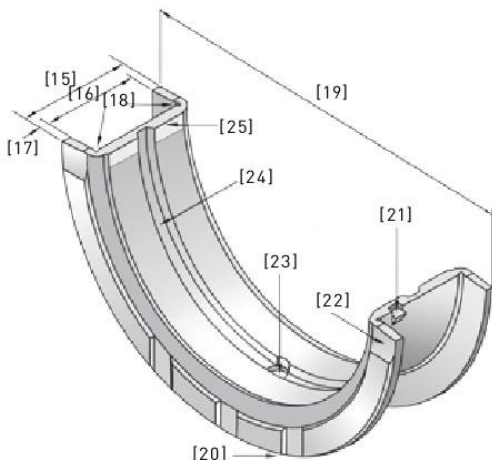

Flange Bearing

15. Flange bearing length
16. Distance between flange
17. Flange thickness
18. Flange relief grooves
19. Flange diameter
20. Relief at joint face
21. Locating lug
22. Relief at joint face
23. Lubrication hole
24. Oil groove
25. Relief at surface
26. Flange and Bearing assembly

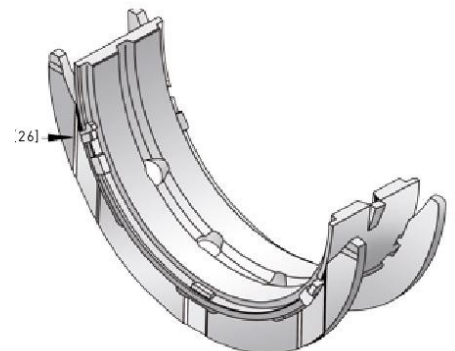



ENGINE VALVE SPECIFICATION

ENGINE VALVE DIMENSION

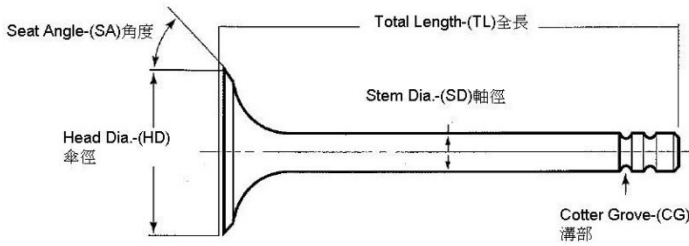

Stem Top Hardness:
HRC 45~60

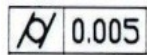

Roundness Tolerance
≤0.005mm

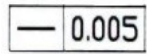

Straightness Tolerance
≤0.005mm

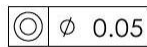

Concentricity Tolerance
≤0.05mm

SPECIFICATION



SHAPE OF COTTER GROOVE (CG)

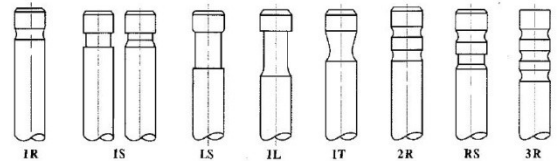

引擎汽門(Engine Valve)使用鋼材對照

材料代號對照					材料化學成分								適用於
Martensitic Steel 麻田散鐵													IN/EX
ISO	JIS	SAE	DIN/BS	大陸	C	Si	Mn	P	S	Ni	Cr	Mo	
42CrMo4	SCM440	4140	EN49		0.43	0.35	0.85				1.2	0.3	
X45CrSi93	SUH1	HNV3	X45CrSi9 3	45Cr9Si3	0.4-0.5	3.0-3.5	≤0.60	≤0.03	≤0.03	≤0.5	7.5-9.0		
	SUH3		X40CrSiMo10-2	40Cr10Si2Mo	0.30-0.45	1.8-2.5	≤0.60	≤0.03	≤0.03	≤0.6	10.0-12.0	0.7-1.3	
	SUH4(XB)	ENV6	EN59	80Cr20Si2Ni	0.75-0.85	1.75-2.25	0.2-0.6	≤0.03	≤0.03	1.15-1.65	19.0-20.5		
X50CrSi82	SUH11	HNV3	EN52	51Cr8Si2	0.45-0.55	1.0-2.0	≤0.60	≤0.03	≤0.03		7.5-9.5		
Austenitic Steel 奧斯田鐵 Non-magnetic													EX
	SUH31	EV9		45Cr14Ni14W2Mo	0.3-0.45	1.5-2.5	≤0.60	≤0.04	≤0.03	13.0-15.0	14.0-16.0		
X53CrMnNiN214	SUH35(21-4N)	EV8	349S54	53Cr21Mn9Ni4N	0.58	≤0.35	8.0-10.0	≤0.01	≤0.03	3.25-4.5	20.0-22.0		
	SUH37(21-12N)	EV4	381S34	20Cr21Ni12N	0.15-0.25	0.75-1.0	1.0-1.5	≤0.025	≤0.025	10.5-12.5	20.0-22.0		
	SUH38				0.25-0.35	≤1.0	≤1.2	0.18-0.25	≤0.03	10.0-12.0	19.0-21.0	1.8-2.5	
Nickel Basic alloy 鎳基合金													EX
NiCr20TiAl	NiMonic 80A	2.4952(HEV5)		GH4080A	0.10max	1.0	1.0		Fe 3.0 max	65.0min	18.0-21.0	Al 1.0-1.5	
NiCr15Fe7TiAl	751	2.4669(HEV3)	NiCr15FeTiAl	GH4751									

STELLITE 鈷鉻鎢合金鋼(軸端與盤面焊補材質)						
	C	Cr	W	Fe	Co	HRC
Stellite #1	2.5	30.0	12.0	3.0 Max	Balance	54
Stellite #6	1.0	28.0	4.0	3.0 Max	Balance	44
Stellite #12	1.35	29.0	8.0	2.0	Balance	47



VALVE SEAT & GUIDE SPECIFICATION

Valve Seat:
High Chrome Alloy Steel
Hardness :HRC 36~47

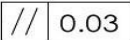
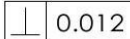
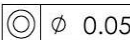
-  0.03 Parallelism Tolerance $\leq 0.03\text{mm}$
-  0.012 Verticality Tolerance $\leq 0.012\text{mm}$
-  ϕ 0.05 Concentricity Tolerance $\leq 0.05\text{mm}$

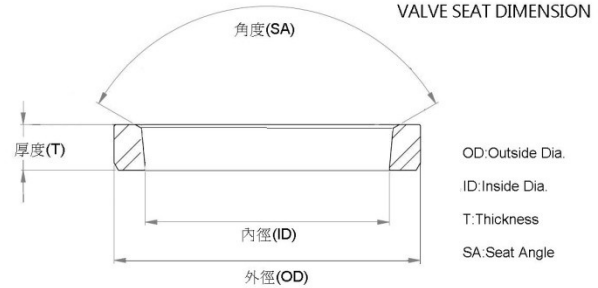

Valve Seat Material

汽門座圈材料成份表

材質:高鉻合金High Chrome Alloy Steel(耐熱合金鑄造鋼)



	C	Si	Mn	P	S	Cr	Mo	Ni	V	Hardness 硬度HRC
高鉻合金 High Chrome Alloy Steel	1.5~2.0	1.5~2.0	0.6~1.2	≤ 0.10	≤ 0.10	13.5~15	0.35~0.5			36~47

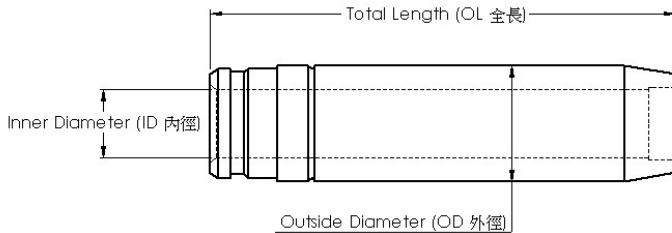

(mm)	Inlet valve (μm)	Exhaust valve (μm)
Stem dia. 6 - 7	10 - 40	25 - 55
Stem dia. 8 - 9	20 - 50	35 - 65
Stem dia. 10 - 12	40 - 70	55 - 85

Valve Guide: Cast Iron FC25

Hardness :HRB 92~102°

- Surface finish Ra $\leq 0.8\mu\text{m}$
- Inner diameter tolerance $\leq 0.01\text{mm}$
- Outer diameter tolerance $\leq 0.01\text{mm}$
- Concentricity diameter tolerance $\leq 0.05\text{mm}$

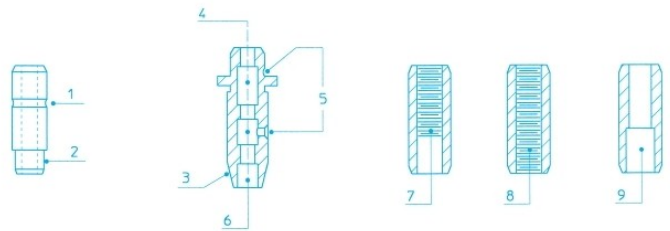

- 1.Outer groove for snap ring
- 2.Narrower end
- 3.Conical end
- 4.Recessd area in the bore
- 5.Lubrifation holes
- 6.Counterbore at end of guides
- 7/8.Lubrifation threads
- 9.Counter bore

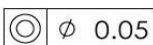
 ϕ 0.05

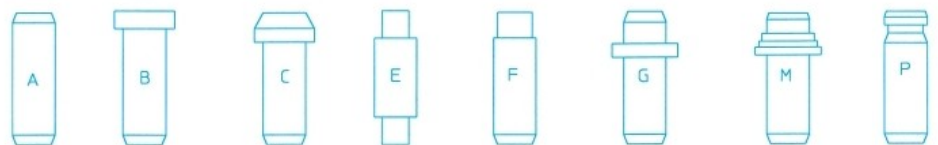



MITSUBISHI DIESEL ENGINE PARTS

TYPE	NO	TYPE	NO
4D30	1	8M20	141~142
4D31	2~6	8M21	143~144
4D31/6D31	7	8M22	145
4D32	8~10	S6A	146~148
4D33	11~13	S6A2	149~150
4D34	14~20	S6B	151
4D35	21~22	S6B2	152~154
4D36	23	S6B3	155
4D55;4D56	24~27	S6N	156~157
4M40	28~30	S3E	158
4M41	31	S3L2	159
4M42/4AT2	32	S4E	160~162
4M42	33~34	S4F	163
4M50	35	S4L	164~166
4M51	36	S4Q	167~168
4D56	37~40	S4S	169
4D68	41	S6E2	170
4DQ5	42~43	S6S	171
4DR	44~46	S6KT	172~173
4M51	47~48	K3B/F/H/M	174~178
6D10	49~50	K4C/D/E	179~183
6D11	51	K4F	184~185
6D14	52~60	K4H/M/N	186~188
6D15	61~67	K4Q(4DQ7)	189
6D16	68~75	L3C	190
6D17	76~77		
6D20	78		
6D22	79~91		
6D24	92~98		
6D40	99~102		
6DB	103~104		
6DS	105~108		
6M60	109~110		
6M70	111~112		
8DC	113~140		

Piston kit-Set

OEM NO. ME012001

Piston	SIZE
Comp : 60.5 w/al-fin Height : -2.8 Length : 110.3 Top Shape : Flower Pin : 34.0 Length : 84.0	STD



Piston Ring

OEM NO. ME012010
NPR : SDM31-014ZX

OEM Ring Groove	SIZE
Top : 3.0K 2nd : 2.0 Oil : 5.0	STD



Cylinder Liner

OEM NO. ME011513

Liner&Sleeve	SIZE
In Diameter : 100.0 Out Diameter : 104.0 Total length : 197.0 Flange :	STD



Engine Bearing

MAIN : ME011530
CON.ROD : ME012227
T/W : ME013564
C/B : SH-1160B
BUSH : ME012257

SIZE
STD



Engine Valve

OEM NO. ME011265
IN 44.0 9.0 137.0
OEM NO. ME011266
EX 37.0 9.0 137.0

SIZE
STD

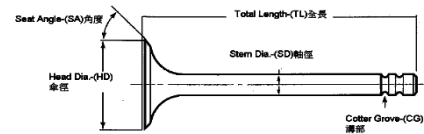

Valve Seat

OEM NO. ME011058
IN 46.0 40.0 6.8
OEM NO. ME013188
EX 39.0 32.8 6.8

SIZE
STD

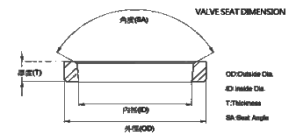

Valve Guide

OEM NO. ME031293
IN/EX 64.0 9.0 15.0

SIZE
STD

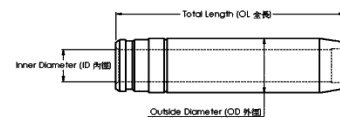

Gasket Set

OEM NO.



Piston kit-Set

OEM NO. ME012906

Piston

SIZE

Comp : 60.7 w/al-fin Height : -18.8 Length : 110.7
Top Shape : Ø52.7
Direct Injection
Pin : 34.0 Length : 84.0

STD



Piston Ring

OEM NO. ME012010
NPR : SDM31-014ZX

OEM Ring Groove

SIZE

Top : 3.0K
2nd : 2.0
Oil : 5.0

STD



Cylinder Liner

OEM NO. ME011604

Liner&Sleeve

SIZE

In Diameter : 100.0
Out Diameter : 104.0
Total length : 191.0
Flange :

STD



Engine Bearing

MAIN : ME011530
CON.ROD : ME012227
T/W : ME013564
C/B : SH-1160B
BUSH : ME012257

SIZE

STD



Engine Valve

OEM NO. ME011265
IN 44.0 9.0 137.0
OEM NO. ME011266
EX 37.0 9.0 137.0

SIZE

STD

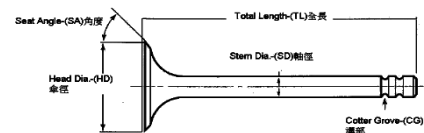

Valve Seat

OEM NO. ME011058
IN 46.0 40.0 6.8
OEM NO. ME013188
EX 39.0 32.8 6.8

SIZE

STD

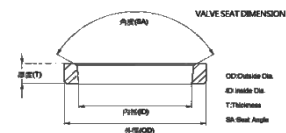

Valve Guide

OEM NO. ME031293
IN/EX 64.0 9.0 15.0

SIZE

STD

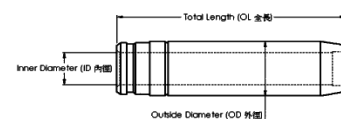

Gasket Set

OEM NO.



Piston kit-Set

OEM NO. ME012131

Piston

SIZE

Comp : 60.7 w/al-fin Height : -19.0 Length : 110.7
Top Shape : Ø53.9
Direct Injection
Pin : 34.0 Length : 84.0

STD



Piston Ring

OEM NO. ME012010
NPR : SDM31-014ZX

OEM Ring Groove

SIZE

Top : 3.0K
2nd : 2.0
Oil : 5.0

STD



Cylinder Liner

OEM NO. ME011604

Liner&Sleeve

SIZE

In Diameter : 100.0
Out Diameter : 104.0
Total length : 191.0
Flange :

STD



Engine Bearing

MAIN : ME011530
CON.ROD : ME012227
T/W : ME013564
C/B : SH-1160B
BUSH : ME012257

SIZE

STD



Engine Valve

OEM NO. ME011265
IN 44.0 9.0 137.0
OEM NO. ME011266
EX 37.0 9.0 137.0

SIZE

STD

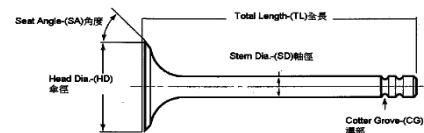

Valve Seat

OEM NO. ME011058
IN 46.0 40.0 6.8
OEM NO. ME013188
EX 39.0 32.8 6.8

SIZE

STD

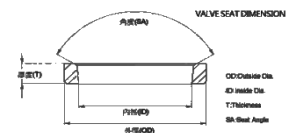

Valve Guide

OEM NO. ME031293
IN/EX 64.0 9.0 15.0

SIZE

STD

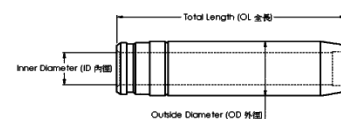

Gasket Set

OEM NO.



MITSUBISHI 4D31A

Application : TRUCK
Number of Cylinders 4
Cylinder dia. 100.0 MM
Swept Volume 3298 ccm

Piston kit-Set

OEM NO. ME012145

Piston

SIZE

Comp : 60.7 w/al-fin Height : -18.6 Length : 110.75
Top Shape : Ø53.0
Direct Injection
Pin : 34.0 Length : 84.0

STD



Piston Ring

OEM NO. ME012010
NPR : SDM31-014ZX

OEM Ring Groove

SIZE

Top : 3.0K
2nd : 2.0
Oil : 5.0

STD



Cylinder Liner

OEM NO. ME011604

Liner&Sleeve

SIZE

In Diameter : 100.0
Out Diameter : 104.0
Total length : 191.0
Flange :

STD



Engine Bearing

MAIN : ME011530
CON.ROD : ME012227
T/W : ME013564
C/B : SH-1160B
BUSH : ME012257

SIZE

STD



Engine Valve

OEM NO. ME011265
IN 44.0 9.0 137.0
OEM NO. ME011266
EX 37.0 9.0 137.0

SIZE

STD

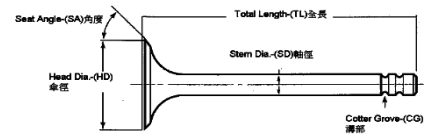

Valve Seat

OEM NO. ME011058
IN 46.0 40.0 6.8
OEM NO. ME013188
EX 39.0 32.8 6.8

SIZE

STD

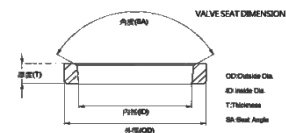

Valve Guide

OEM NO. ME031293
IN/EX 64.0 9.0 15.0

SIZE

STD

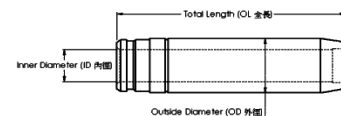

Gasket Set

OEM NO.



MITSUBISHI

4D31T

Application : TRUCK
 Number of Cylinders 4
 Cylinder dia. 100.0 MM
 Swept Volume 3298 ccm

Piston kit-Set

OEM NO. ME012155

Piston

SIZE

Comp : 60.7 w/al-fin Height : -18.5 Length : 110.7
 Top Shape : Ø52.0
 Direct Injection
 Pin : 34.0 Length : 84.0

STD

Piston Ring

OEM NO. ME997396
 NPR : SDM31-081ZX

OEM Ring Groove

SIZE

Top : 3.0K
 2nd : 2.0
 Oil : 4.0

STD



Cylinder Liner

OEM NO. ME011604

Liner&Sleeve

SIZE

In Diameter : 100.0
 Out Diameter : 104.0
 Total length : 191.0
 Flange :

STD



Engine Bearing

MAIN : ME011530
 CON.ROD : ME012227
 T/W : ME013564
 C/B : SH-1160B
 BUSH : ME012234

SIZE

STD



Engine Valve

OEM NO. ME011265
 IN 44.0 9.0 137.0
 OEM NO. ME011266
 EX 37.0 9.0 137.0

SIZE

STD

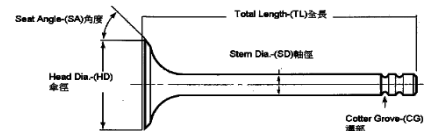

Valve Seat

OEM NO. ME011058
 IN 46.0 40.0 6.8
 OEM NO. ME013188
 EX 39.0 32.8 6.8

SIZE

STD

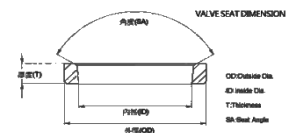

Valve Guide

OEM NO. ME031293
 IN/EX 64.0 9.0 15.0

SIZE

STD

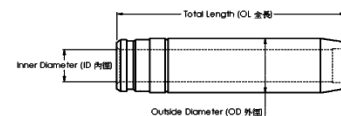

Gasket Set

OEM NO.



MITSUBISHI 4D31T

Application : TRUCK
Number of Cylinders 4
Cylinder dia. 100.0 MM
Swept Volume 3298 ccm

Piston kit-Set

OEM NO. ME012858



Piston

SIZE

Comp : 60.7 w/al-fin Height : -18.0 Length : 110.7
Top Shape : Ø54.5
Direct Injection
Pin : 34.0 Length : 84.0

STD

Piston Ring

OEM NO. ME997396
NPR : SDM31-081ZX

OEM Ring Groove

SIZE

Top : 3.0K
2nd : 2.0
Oil : 4.0

STD



Cylinder Liner

OEM NO. ME011604

Liner&Sleeve

SIZE

In Diameter : 100.0
Out Diameter : 104.0
Total length : 191.0
Flange :

STD



Engine Bearing

MAIN : ME011530
CON.ROD : ME012227
T/W : ME013564
C/B : SH-1160B
BUSH : ME012234

SIZE

STD



Engine Valve

OEM NO. ME011265
IN 44.0 9.0 137.0
OEM NO. ME011266
EX 37.0 9.0 137.0

SIZE

STD

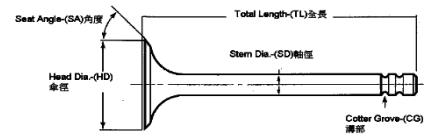

Valve Seat

OEM NO. ME011058
IN 46.0 40.0 6.8
OEM NO. ME013188
EX 39.0 32.8 6.8

SIZE

STD

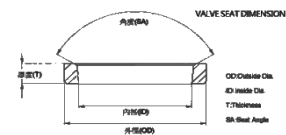

Valve Guide

OEM NO. ME031293
IN/EX 64.0 9.0 15.0

SIZE

STD

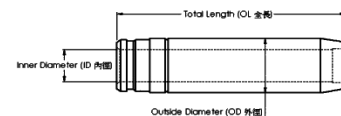

Gasket Set

OEM NO.



MITSUBISHI 4D31T/6D31T

Application : TRUCK
Number of Cylinders 4 / 6
Cylinder dia. 100.0 MM
Swept Volume 3298 ccm / 4948 ccm

Piston kit-Set

OEM NO. ME082542



Piston

SIZE

Comp : 60.7 w/al-fin Height : -18.0 Length : 110.7
Top Shape : Ø47.0
Direct Injection
Pin : 34.0 Length : 83.5

STD

Piston Ring

OEM NO. ME997396
NPR : SDM31-081ZX



OEM Ring Groove

SIZE

Top : 3.0K
2nd : 2.0
Oil : 4.0

STD

Cylinder Liner

OEM NO. ME011604



Liner&Sleeve

SIZE

In Diameter : 100.0
Out Diameter : 104.0
Total length : 191.0
Flange :

STD

Engine Bearing

MAIN : ME011530
CON.ROD : ME012227
T/W : ME013564
C/B : SH-1160B
BUSH : ME012234



SIZE

STD

Engine Valve

OEM NO. ME011265
IN 44.0 9.0 137.0
OEM NO. ME011266
EX 37.0 9.0 137.0

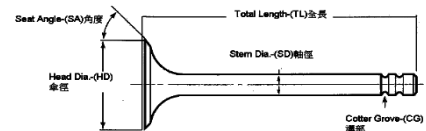

SIZE

STD

Valve Seat

OEM NO. ME011058
IN 46.0 40.0 6.8
OEM NO. ME013188
EX 39.0 32.8 6.8

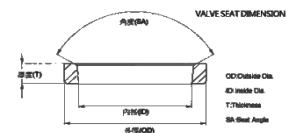

SIZE

STD

Valve Guide

OEM NO. ME031293
IN/EX 64.0 9.0 15.0

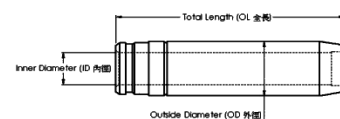

SIZE

STD

Gasket Set

OEM NO.



Piston kit-Set

OEM NO. ME012174

Piston

SIZE

Comp : 60.7 w/al-fin Height : -18.7 Length : 110.7
Top Shape : Ø54.4
Direct Injection
Pin : 34.0 Length : 84.0

STD



Piston Ring

OEM NO. ME997318

NPR : SJM31-098ZZ

OEM Ring Groove

SIZE

Top : 3.0K
2nd : 2.0
Oil : 4.0

STD



Cylinder Liner

OEM NO. ME012900

Liner&Sleeve

SIZE

In Diameter : 104.0
Out Diameter : 107.5
Total length : 198.0
Flange :

STD



Engine Bearing

MAIN : ME011530
CON.ROD : ME012227
T/W : ME013564
C/B : SH-1160B
BUSH : ME012234

SIZE

STD



Engine Valve

OEM NO. ME011265
IN 44.0 9.0 137.0
OEM NO. ME011266
EX 37.0 9.0 137.0

SIZE

STD

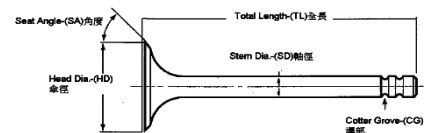

Valve Seat

OEM NO. ME011058
IN 46.0 40.0 6.8
OEM NO. ME013188
EX 39.0 32.8 6.8

SIZE

STD

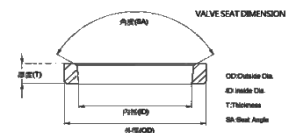

Valve Guide

OEM NO. ME031293
IN/EX 64.0 9.0 15.0

SIZE

STD

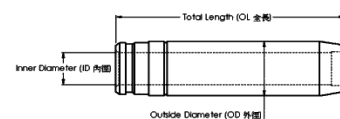

Gasket Set

OEM NO.



MITSUBISHI 4D32

Application : TRUCK
Number of Cylinders 4
Cylinder dia. 104.0 MM
Swept Volume 3567 ccm

Piston kit-Set

OEM NO. ME018274

Piston	SIZE
Comp : 60.9 w/al-fin Height : -18.7 Length : 110.7 Top Shape : Ø51.5 Direct Injection Pin : 34.0 Length : 84.0	STD



Piston Ring

OEM NO. ME997240
NPR : SJM31-075ZZ

OEM Ring Groove	SIZE
Top : 2.806DK 2nd : 2.0 Oil : 4.0	STD



Cylinder Liner

OEM NO. ME012900

Liner&Sleeve	SIZE
In Diameter : 104.0 Out Diameter : 107.5 Total length : 198.0 Flange :	STD



Engine Bearing

MAIN : ME011530
CON.ROD : ME012227
T/W : ME013564
C/B : SH-1160B
BUSH : ME012234

SIZE
STD



Engine Valve

OEM NO. ME011265
IN 44.0 9.0 137.0
OEM NO. ME011266
EX 37.0 9.0 137.0

SIZE
STD

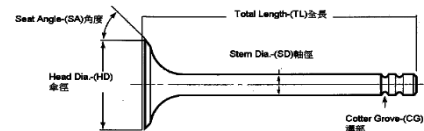

Valve Seat

OEM NO. ME011058
IN 46.0 40.0 6.8
OEM NO. ME013188
EX 39.0 32.8 6.8

SIZE
STD

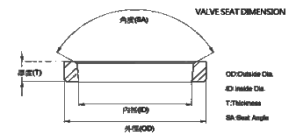

Valve Guide

OEM NO. ME031293
IN/EX 64.0 9.0 15.0

SIZE
STD

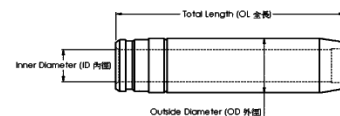

Gasket Set

OEM NO.



MITSUBISHI 4D32

Application : TRUCK
Number of Cylinders 4
Cylinder dia. 104.0 MM
Swept Volume 3567 ccm

Piston kit-Set

OEM NO. ME018277

Piston

SIZE

Comp : 62.4 w/al-fin Height : -20.4 Length : 112.3
Top Shape : Ø51.9
Direct Injection
Pin : 34.0 Length : 84.0

STD



Piston Ring

OEM NO. ME997318

NPR : SJM31-098ZZ

OEM Ring Groove

SIZE

Top : 3.0K
2nd : 2.0
Oil : 4.0

STD



Cylinder Liner

OEM NO. ME012900

Liner&Sleeve

SIZE

In Diameter : 104.0
Out Diameter : 107.5
Total length : 198.0
Flange :

STD



Engine Bearing

MAIN : ME011530
CON.ROD : ME012227
T/W : ME013564
C/B : SH-1160B
BUSH : ME012234

SIZE

STD



Engine Valve

OEM NO. ME011265
IN 44.0 9.0 137.0
OEM NO. ME011266
EX 37.0 9.0 137.0

SIZE

STD

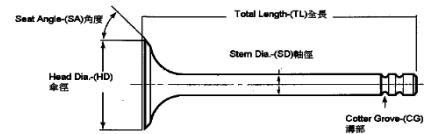

Valve Seat

OEM NO. ME011058
IN 46.0 40.0 6.8
OEM NO. ME013188
EX 39.0 32.8 6.8

SIZE

STD

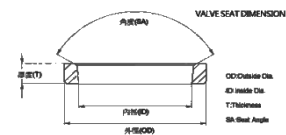

Valve Guide

OEM NO. ME031293
IN/EX 64.0 9.0 15.0

SIZE

STD

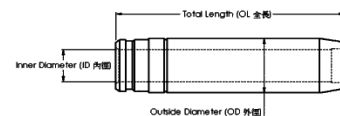

Gasket Set

OEM NO.



Piston kit-Set

OEM NO. ME013129

Piston

SIZE

Comp : 62.2 w/al-fin Height : -20.8 Length : 112.2
Top Shape : Ø56.0
Direct Injection
Pin : 34.0 Length : 84.0

STD

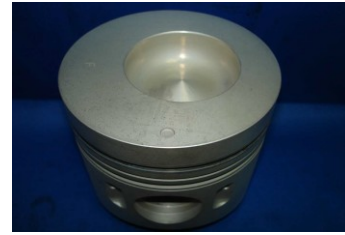

Piston Ring

OEM NO. ME996378
NPR : SDM31-097ZZ

OEM Ring Groove

SIZE

Top : 3.0
2nd : 2.0
Oil : 4.0

STD



Cylinder Liner

OEM NO. ME012900

Liner&Sleeve

SIZE

In Diameter : 104.0
Out Diameter : 107.5
Total length : 198.0
Flange :

STD



Engine Bearing

MAIN : ME011530
CON.ROD : ME012227
T/W : ME013564
C/B : SH-1160B
BUSH : ME012234

SIZE

STD



Engine Valve

OEM NO. ME011265
IN 44.0 9.0 137.0
OEM NO. ME011266
EX 37.0 9.0 137.0

SIZE

STD

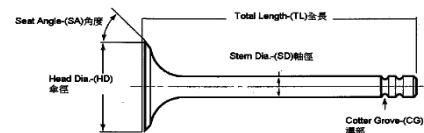

Valve Seat

OEM NO. ME011058
IN 46.0 40.0 6.8
OEM NO. ME013188
EX 39.0 32.8 6.8

SIZE

STD

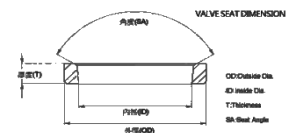

Valve Guide

OEM NO. ME031293
IN/EX 64.0 9.0 15.0

SIZE

STD

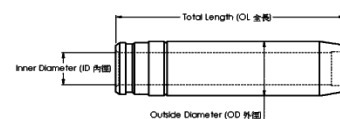

Gasket Set

OEM NO.



Piston kit-Set

OEM NO. ME016895/ME012897

Piston	SIZE
Comp : 62.2 w/al-fin Height : -21.0 Length : 112.2 Top Shape : Ø54.0 Direct Injection Pin : 34.0 Length : 84.0	STD



Piston Ring

OEM NO. ME996378
NPR : SDM31-097ZZ

OEM Ring Groove	SIZE
Top : 3.0 2nd : 2.0 Oil : 4.0	STD



Cylinder Liner

OEM NO. ME012900

Liner&Sleeve	SIZE
In Diameter : 104.0 Out Diameter : 107.5 Total length : 198.0 Flange :	STD



Engine Bearing

MAIN : ME011530
CON.ROD : ME012227
T/W : ME013564
C/B : SH-1160B
BUSH : ME012234

SIZE
STD



Engine Valve

OEM NO. ME011265
IN 44.0 9.0 137.0
OEM NO. ME011266
EX 37.0 9.0 137.0

SIZE
STD

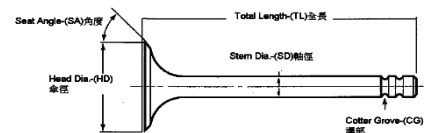

Valve Seat

OEM NO. ME011058
IN 46.0 40.0 6.8
OEM NO. ME013188
EX 39.0 32.8 6.8

SIZE
STD

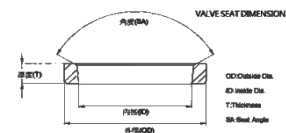

Valve Guide

OEM NO. ME031293
IN/EX 64.0 9.0 15.0

SIZE
STD

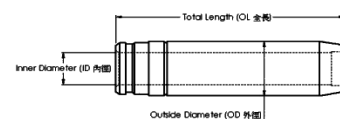

Gasket Set

OEM NO.



MITSUBISHI 4D33.4A

Application : TRUCK
Number of Cylinders 4
Cylinder dia. 108.0 MM
Swept Volume 4214 ccm

Piston kit-Set

OEM NO. ME018280/ME016895

Piston	SIZE
Comp : 62.2 w/al-fin Height : -21.0 Length : 112.2 Top Shape : Ø54.5 Direct Injection Pin : 34.0 Length : 84.0	STD

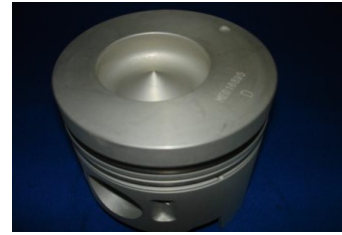

Piston Ring

OEM NO. ME996378
NPR : SDM31-097ZZ

OEM Ring Groove	SIZE
Top : 3.0 2nd : 2.0 Oil : 4.0	STD



Cylinder Liner

OEM NO. ME012900

Liner&Sleeve	SIZE
In Diameter : 104.0 Out Diameter : 107.5 Total length : 198.0 Flange :	STD



Engine Bearing

MAIN : ME011530
CON.ROD : ME012227
T/W : ME013564
C/B : SH-1160B
BUSH : ME012234

SIZE
STD



Engine Valve

OEM NO. ME011265
IN 44.0 9.0 137.0
OEM NO. ME011266
EX 37.0 9.0 137.0

SIZE
STD

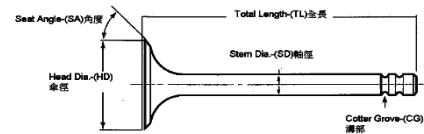

Valve Seat

OEM NO. ME011058
IN 46.0 40.0 6.8
OEM NO. ME013188
EX 39.0 32.8 6.8

SIZE
STD

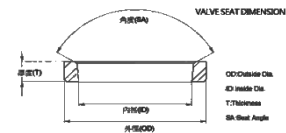

Valve Guide

OEM NO. ME031293
IN/EX 64.0 9.0 15.0

SIZE
STD

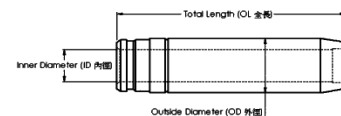

Gasket Set

OEM NO.



Piston kit-Set

OEM NO. ME012928

Piston

SIZE

Comp : 62.2 w/al-fin Height : -20.4 Length : 112.2
Top Shape : Ø54.5
Direct Injection
Pin : 34.0 Length : 84.0

STD



Piston Ring

OEM NO. ME997318

NPR : SJM31-098ZZ

OEM Ring Groove

SIZE

Top : 3.0K
2nd : 2.0
Oil : 4.0

STD



Cylinder Liner

OEM NO. ME013366

Liner&Sleeve

SIZE

In Diameter : 104.0
Out Diameter : 108.0
Total length : 198.0
Flange :

STD



Engine Bearing

MAIN : ME011530
CON.ROD : ME997261
T/W : ME013564
C/B :
BUSH : ME012257

SIZE

STD



Engine Valve

OEM NO. ME011265
IN 44.0 9.0 137.0
OEM NO. ME011266
EX 37.0 9.0 137.0

SIZE

STD

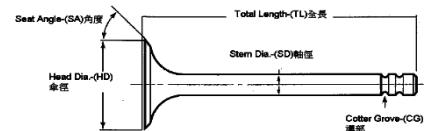

Valve Seat

OEM NO. ME011058
IN 46.0 40.0 6.8
OEM NO. ME013188
EX 39.0 32.8 6.8

SIZE

STD

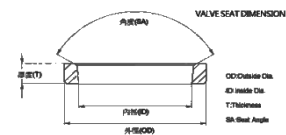

Valve Guide

OEM NO. ME031293
IN/EX 64.0 9.0 15.0

SIZE

STD

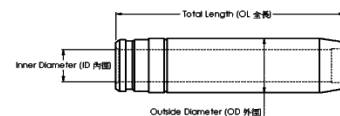

Gasket Set

OEM NO.



MITSUBISHI

4D34T

Application : TRUCK
Number of Cylinders 4
Cylinder dia. 104.0 MM
Swept Volume 3907 ccm

Piston kit-Set

OEM NO. 23411-45050

Piston

SIZE

Comp : 62.1 w/al-fin Height : -23.0 oil-cooled Length : 112.2
 Top Shape : Ø49.0
 Direct Injection
 Pin : 36.0 Length : 88.0

STD



Piston Ring

OEM NO. ME996566
 NPR : SDM31-075ZZ

OEM Ring Groove

SIZE

Top : 2.8K
 2nd : 2.0
 Oil : 4.0

STD



Cylinder Liner

OEM NO. ME013366

Liner&Sleeve

SIZE

In Diameter : 104.0
 Out Diameter : 108.0
 Total length : 198.0
 Flange :

STD



Engine Bearing

MAIN : ME011530
 CON.ROD : ME997261
 T/W : ME013560
 C/B :
 BUSH : ME013075

SIZE

STD



Engine Valve

OEM NO. ME011265
 IN 44.0 9.0 137.0
 OEM NO. ME011266
 EX 37.0 9.0 137.0

SIZE

STD

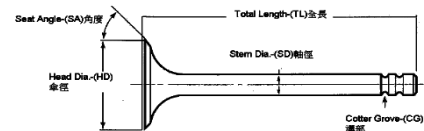

Valve Seat

OEM NO. ME011058
 IN 46.0 40.0 6.8
 OEM NO. ME013188
 EX 39.0 32.8 6.8

SIZE

STD

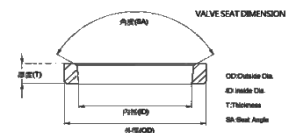

Valve Guide

OEM NO. ME031293
 IN/EX 64.0 9.0 15.0

SIZE

STD

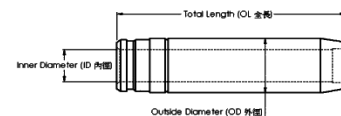

Gasket Set

OEM NO.



Piston kit-Set

OEM NO. ME013325

Piston

SIZE

Comp : 62.1 w/al-fin Height : -20.5 Length : 112.2
Top Shape : Ø56.0
Direct Injection
Pin : 36.0 Length : 88.0

STD



Piston Ring

OEM NO. ME996566
NPR : SDM31-075ZZ

OEM Ring Groove

SIZE

Top : 2.8K
2nd : 2.0
Oil : 4.0

STD



Cylinder Liner

OEM NO. ME013366

Liner&Sleeve

SIZE

In Diameter : 104.0
Out Diameter : 108.0
Total length : 198.0
Flange :

STD



Engine Bearing

MAIN : ME011530
CON.ROD : ME997261
T/W : ME013560
C/B :
BUSH : ME013075

SIZE

STD



Engine Valve

OEM NO. ME011265
IN 44.0 9.0 137.0
OEM NO. ME011266
EX 37.0 9.0 137.0

SIZE

STD

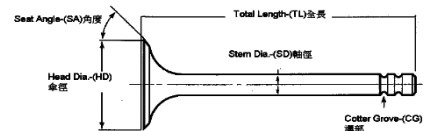

Valve Seat

OEM NO. ME011058
IN 46.0 40.0 6.8
OEM NO. ME013188
EX 39.0 32.8 6.8

SIZE

STD

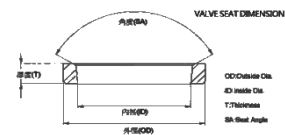

Valve Guide

OEM NO. ME031293
IN/EX 64.0 9.0 15.0

SIZE

STD

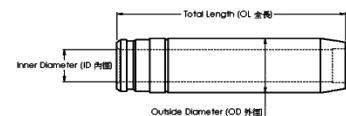

Gasket Set

OEM NO.



Piston kit-Set

OEM NO. ME014160/ME088990

Piston

SIZE

Comp : 62.1 w/al-fin Height : -20.6 Length : 112.2
 Top Shape : Ø54.5
 Direct Injection
 Pin : 36.0 Length : 88.0

STD



Piston Ring

OEM NO. ME996566
 NPR : SDM31-075ZZ

OEM Ring Groove

SIZE

Top : 2.8K
 2nd : 2.0
 Oil : 4.0

STD



Cylinder Liner

OEM NO. ME013366

Liner&Sleeve

SIZE

In Diameter : 104.0
 Out Diameter : 108.0
 Total length : 198.0
 Flange :

STD



Engine Bearing

MAIN : ME011530
 CON.ROD : ME997261
 T/W : ME013560
 C/B :
 BUSH : ME013075

SIZE

STD



Engine Valve

OEM NO. ME011265
 IN 44.0 9.0 137.0
 OEM NO. ME011266
 EX 37.0 9.0 137.0

SIZE

STD

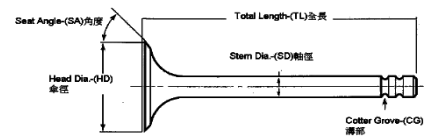

Valve Seat

OEM NO. ME011058
 IN 46.0 40.0 6.8
 OEM NO. ME013188
 EX 39.0 32.8 6.8

SIZE

STD

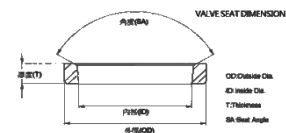

Valve Guide

OEM NO. ME031293
 IN/EX 64.0 9.0 15.0

SIZE

STD

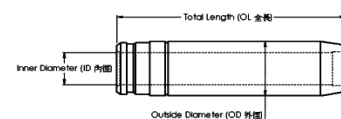

Gasket Set

OEM NO.



MITSUBISHI

4D34T

Application : TRUCK
 Number of Cylinders 4
 Cylinder dia. 104.0 MM
 Swept Volume 3907 ccm

Piston kit-Set

OEM NO. ME082602

Piston	SIZE
Comp : 62.1 w/al-fin Height : -20.5 Length : 112.2 Top Shape : Ø54.0 Direct Injection Pin : 36.0 Length : 88.0	STD

Piston Ring

OEM NO. ME996566
 NPR : SDM31-075ZZ

OEM Ring Groove	SIZE
Top : 2.8DK 2nd : 2.0 Oil : 4.0	STD



Cylinder Liner

OEM NO. ME013366

Liner&Sleeve	SIZE
In Diameter : 104.0 Out Diameter : 108.0 Total length : 198.0 Flange :	STD



Engine Bearing

MAIN : ME011530
 CON.ROD : ME997261
 T/W : ME013560
 C/B :
 BUSH : ME013075

SIZE
 STD



Engine Valve

OEM NO. ME011265
 IN 44.0 9.0 137.0
 OEM NO. ME011266
 EX 37.0 9.0 137.0

SIZE
 STD

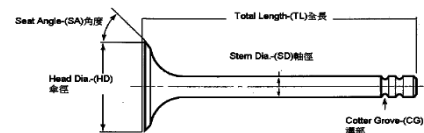

Valve Seat

OEM NO. ME011058
 IN 46.0 40.0 6.8
 OEM NO. ME013188
 EX 39.0 32.8 6.8

SIZE
 STD

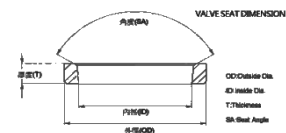

Valve Guide

OEM NO. ME031293
 IN/EX 64.0 9.0 15.0

SIZE
 STD

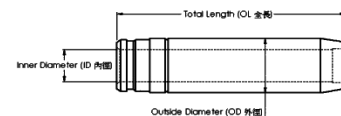

Gasket Set

OEM NO.



MITSUBISHI

4D34T

Application : TRUCK
Number of Cylinders 4
Cylinder dia. 104.0 MM
Swept Volume 3907 ccm

Piston kit-Set

OEM NO. ME220454

Piston

SIZE

Comp : 62.1 w/al-fin Height : -20.5 oil-cooled Length : 112.2
 Top Shape : Ø51.9
 Direct Injection
 Pin : 36.0 Length : 88.0

STD



Piston Ring

OEM NO. ME996566
 NPR : SDM31-075ZZ

OEM Ring Groove

SIZE

Top : 2.8DK
 2nd : 2.0
 Oil : 4.0

STD



Cylinder Liner

OEM NO. ME013366

Liner&Sleeve

SIZE

In Diameter : 104.0
 Out Diameter : 108.0
 Total length : 198.0
 Flange :

STD



Engine Bearing

MAIN : ME011530
 CON.ROD : ME997261
 T/W : ME013560
 C/B :
 BUSH : ME013075

SIZE

STD



Engine Valve

OEM NO. ME011265
 IN 44.0 9.0 137.0
 OEM NO. ME011266
 EX 37.0 9.0 137.0

SIZE

STD

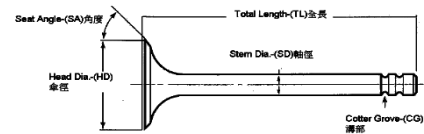

Valve Seat

OEM NO. ME011058
 IN 46.0 40.0 6.8
 OEM NO. ME013188
 EX 39.0 32.8 6.8

SIZE

STD

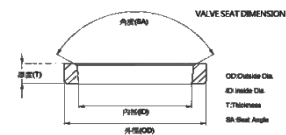

Valve Guide

OEM NO. ME031293
 IN/EX 64.0 9.0 15.0

SIZE

STD

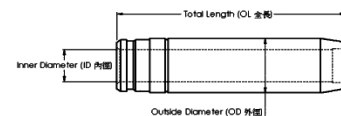

Gasket Set

OEM NO.



MITSUBISHI

4D34T

Application : TRUCK
Number of Cylinders 4
Cylinder dia. 104.0 MM
Swept Volume 3907 ccm

Piston kit-Set

OEM NO. ME220470

Piston

SIZE

Comp : 62.1 w/al-fin Height : -23.0 oil-cooled Length : 112.2
 Top Shape : Ø49.0
 Direct Injection
 Pin : 36.0 Length : 88.0

STD



Piston Ring

OEM NO. ME996566
 NPR : SDM31-075ZZ

OEM Ring Groove

SIZE

Top : 2.8DK
 2nd : 2.0
 Oil : 4.0

STD



Cylinder Liner

OEM NO. ME013366

Liner&Sleeve

SIZE

In Diameter : 104.0
 Out Diameter : 108.0
 Total length : 198.0
 Flange :

STD



Engine Bearing

MAIN : ME011530
 CON.ROD : ME997261
 T/W : ME013560
 C/B :
 BUSH : ME013075

SIZE

STD



Engine Valve

OEM NO. ME011265
 IN 44.0 9.0 137.0
 OEM NO. ME011266
 EX 37.0 9.0 137.0

SIZE

STD

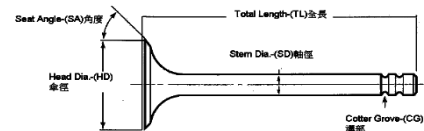

Valve Seat

OEM NO. ME011058
 IN 46.0 40.0 6.8
 OEM NO. ME013188
 EX 39.0 32.8 6.8

SIZE

STD

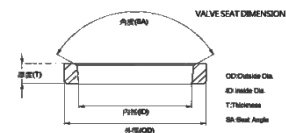

Valve Guide

OEM NO. ME031293
 IN/EX 64.0 9.0 15.0

SIZE

STD

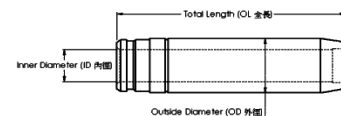

Gasket Set

OEM NO.



Piston kit-Set

OEM NO. ME014693

Piston

SIZE

Comp : 59.8 w/al-fin Height : -21.5 oil-cooled Length : 109.5
Top Shape : Ø56.3
Direct Injection
Pin : 36.0 Length : 88.0

STD



Piston Ring

OEM NO. ME996628
NPR : SDM31-118ZZ

OEM Ring Groove

SIZE

Top : 3.0
2nd : 2.5
Oil : 4.0

STD



Cylinder Liner

OEM NO.

Liner&Sleeve

SIZE

In Diameter : 110.0
Out Diameter : 113.0
Total length : 200.0
Flange :

STD



Engine Bearing

MAIN : ME011530
CON.ROD : ME997261
T/W : ME013560
C/B :
BUSH : ME013075

SIZE

STD



Engine Valve

OEM NO. ME031938/297
IN 47.0 9.0 137.0
OEM NO. ME031940/154
EX 40.0 9.0 137.0

SIZE

STD

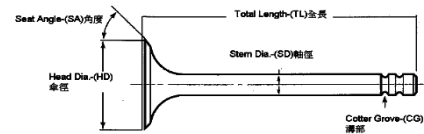

Valve Seat

OEM NO. ME031931/32
IN 49.0 40.0 6.8
OEM NO. ME031935/36
EX 42.0 36.0 6.8

SIZE

STD

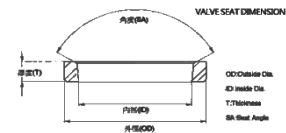

Valve Guide

OEM NO. ME031293
IN 64.0 9.0 15.0
OEM NO. ME031888
EX 71.5 9.0 15.0

SIZE

STD

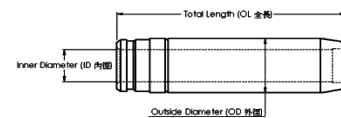

Gasket Set

OEM NO.



Piston kit-Set

OEM NO. ME014898

Piston

SIZE

 Comp : 59.7 w/al-fin Height : -21.3 oil-cooled Length : 109.5
 Top Shape : Ø56.5
 Direct Injection
 Pin : 36.0 Length : 88.0

STD



Piston Ring

OEM NO. ME996628

NPR : SDM31-118ZZ

OEM Ring Groove

SIZE

 Top : 3.0
 2nd : 2.5
 Oil : 4.0

STD



Cylinder Liner

OEM NO.

Liner&Sleeve

SIZE

 In Diameter : 110.0
 Out Diameter : 113.0
 Total length : 200.0
 Flange :

STD



Engine Bearing

 MAIN : ME011530
 CON.ROD : ME997261
 T/W : ME013560
 C/B :
 BUSH : ME013075

SIZE

STD



Engine Valve

 OEM NO. ME031938/297
 IN 47.0 9.0 137.0
 OEM NO. ME031940/154
 EX 40.0 9.0 137.0

SIZE

STD

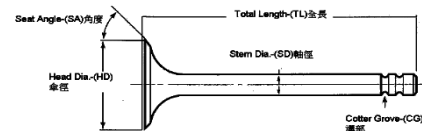

Valve Seat

 OEM NO. ME031931/32
 IN 49.0 40.0 6.8
 OEM NO. ME031935/36
 EX 42.0 36.0 6.8

SIZE

STD

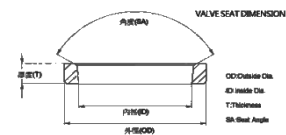

Valve Guide

 OEM NO. ME031293
 IN 64.0 9.0 15.0
 OEM NO. ME031888
 EX 71.5 9.0 15.0

SIZE

STD

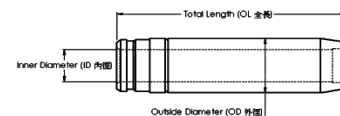

Gasket Set

OEM NO.



Piston kit-Set

OEM NO. ME018283



Piston

SIZE

Comp : 60.5 w/al-fin Height : -2.3 Length : 110.5
Top Shape : Flower
Pin : 34.0
Length : 84.0

STD

Piston Ring

OEM NO.

NPR : SDM31-075ZZ



OEM Ring Groove

SIZE

Top : 2.8DK
2nd : 2.0
Oil : 4.0

STD

Cylinder Liner

OEM NO.



Liner&Sleeve

SIZE

In Diameter : 104.0
Out Diameter : 108.0
Total length : 197.0
Flange :

STD

Engine Bearing

MAIN : ME011530
CON.ROD : ME997261
T/W : ME013560
C/B :
BUSH : ME012257



SIZE

STD

Engine Valve

OEM NO.
IN
OEM NO.
EX

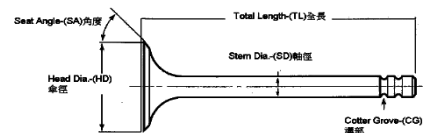

SIZE

STD

Valve Seat

OEM NO.
IN
OEM NO.
EX

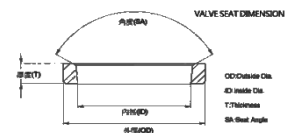

SIZE

STD

Valve Guide

OEM NO.
IN
OEM NO.
EX

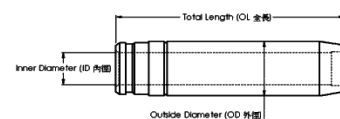

SIZE

STD

Gasket Set

OEM NO.



MITSUBISHI

4D55T/4D56T

Application : TRUCK
Number of Cylinders 4
Cylinder dia. 91.1 MM
Swept Volume 2476/2476 ccm

Piston kit-Set

OEM NO. MD050011/MD103308

Piston	SIZE
Comp : 48.7 w/al-fin Height : -2.8 Length : 88.5 Top Shape : Flower Pin : 29.0 Length : 74.0	STD



Piston Ring

OEM NO. MD050390
NPR : SDM31-038ZX

OEM Ring Groove	SIZE
Top : 2.5K 2nd : 2.0 Oil : 4.0	STD



Cylinder Liner

OEM NO. MD050430

Liner&Sleeve	SIZE
In Diameter : 91.1 Out Diameter : 94.1 Total length : 165.0 Flange :	STD



Engine Bearing

MAIN : MD050360
CON.ROD : MD026430
T/W :
C/B :
BUSH : MD050009

SIZE
STD



Engine Valve

OEM NO. MD083661
IN 40.0 8.0 136.5 1R
OEM NO. MD083662
EX 34.0 8.0 136.5 1R

SIZE
STD

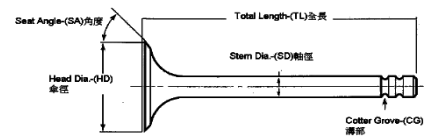

Valve Seat

OEM NO. MD050514
IN 43.5 36.0 7.2
OEM NO. MD050517
EX 37.5 30.0 7.2

SIZE
STD

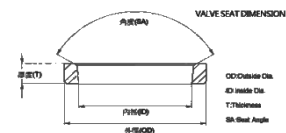

Valve Guide

OEM NO. MD050523
IN 71.0 8.0 13.0
OEM NO. MD050527
EX 74.0 8.0 13.0

SIZE
STD

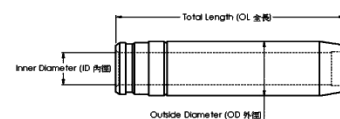

Gasket Set

OEM NO.



MITSUBISHI

4D55/4D56

Application : TRUCK
Number of Cylinders 4
Cylinder dia. 91.1 MM
Swept Volume 2346/2476 ccm

Piston kit-Set

OEM NO. MD050021/MD103318

Piston	SIZE
Comp : 48.7 Height : -2.8 Length : 88.5 Top Shape : Flower Pin : 29.0 Length : 74.0	STD



Piston Ring

OEM NO. MD050395
NPR : SDM31-055ZX

OEM Ring Groove	SIZE
Top : 2.5 2nd : 2.0 Oil : 4.0	STD



Cylinder Liner

OEM NO. MD050430

Liner&Sleeve	SIZE
In Diameter : 91.1 Out Diameter : 94.1 Total length : 165.0 Flange :	STD



Engine Bearing

MAIN : MD050360
CON.ROD : MD026430
T/W :
C/B :
BUSH : MD050009

SIZE
STD



Engine Valve

OEM NO. MD083661
IN 40.0 8.0 136.5
OEM NO. MD083662
EX 34.0 8.0 136.5

SIZE
STD

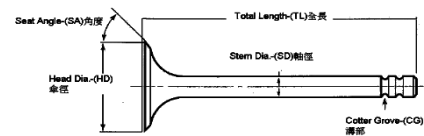

Valve Seat

OEM NO. MD050514
IN 43.5 36.0 7.2
OEM NO. MD050517
EX 37.5 30.0 7.2

SIZE
STD

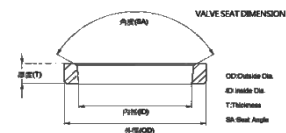

Valve Guide

OEM NO. MD050523
IN 71.0 8.0 13.0
OEM NO. MD050527
EX 74.0 8.0 13.0

SIZE
STD

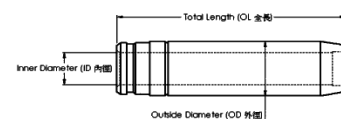

Gasket Set

OEM NO.



MITSUBISHI

4D55/4D56

Application : TRUCK
Number of Cylinders 4
Cylinder dia. 91.1 MM
Swept Volume 2346/2476 ccm

Piston kit-Set

OEM NO. MD182601(R) / MD182607(L)



Piston	SIZE
Comp : 48.9 Height : -2.7 Length : 88.75 Top Shape : Flower Pin : 29.0 Length : 74.0	STD

Piston Ring

OEM NO. MD050390
NPR : SDM31-058ZX



OEM Ring Groove	SIZE
Top : 2.5HK 2nd : 2.0 Oil : 4.0	STD

Cylinder Liner

OEM NO. MD050430



Liner&Sleeve	SIZE
In Diameter : 91.1 Out Diameter : 94.1 Total length : 165.0 Flange :	STD

Engine Bearing

MAIN : MD050360
CON.ROD : MD026430
T/W :
C/B :
BUSH : MD050009



	SIZE
	STD

Engine Valve

OEM NO. MD083661
IN 40.0 8.0 136.5
OEM NO. MD083662
EX 34.0 8.0 136.5

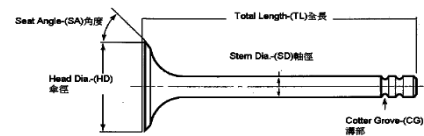

	SIZE
	STD

Valve Seat

OEM NO. MD050514
IN 43.5 36.0 7.2
OEM NO. MD050517
EX 37.5 30.0 7.2

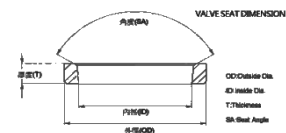

	SIZE
	STD

Valve Guide

OEM NO. MD050523
IN 71.0 8.0 13.0
OEM NO. MD050527
EX 74.0 8.0 13.0

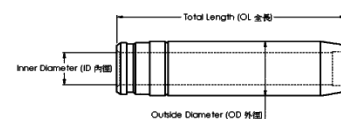

	SIZE
	STD

Gasket Set

OEM NO.



Piston kit-Set

OEM NO. MD304835/MD304838

Piston	SIZE
Comp : 48.7 Height : -2.6 Length : 88.7 Top Shape : Flower Pin : 29.0 Length : 75.0	STD 0.50

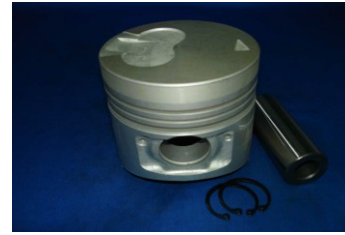

Piston Ring

OEM NO. MD050395
NPR : SDM31-055ZX

OEM Ring Groove	SIZE
Top : 2.5 2nd : 2.0 Oil : 4.0	STD 0.50



Cylinder Liner

OEM NO. MD050430

Liner&Sleeve	SIZE
In Diameter : 91.1 Out Diameter : 94.1 Total length : 165.0 Flange :	STD



Engine Bearing

MAIN : MD050360
CON.ROD : MD026430
T/W :
C/B :
BUSH : MD050009

SIZE
STD



Engine Valve

OEM NO. MD198403
IN 40.0 8.0 130.0
OEM NO. MD198405
EX 34.0 8.0 130.0

SIZE
STD

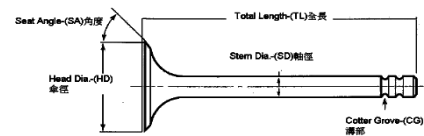

Valve Seat

OEM NO. MD050514
IN 43.5 36.0 7.2
OEM NO. MD050517
EX 37.5 30.0 7.2

SIZE
STD

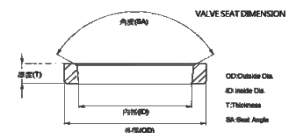

Valve Guide

OEM NO. MD050523
IN 71.0 8.0 13.0
OEM NO. MD050527
EX 74.0 8.0 13.0

SIZE
STD

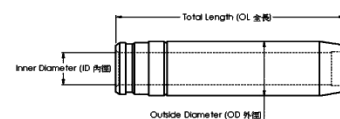

Gasket Set

OEM NO.



Piston kit-Set

OEM NO. ME200680

Piston	SIZE
Comp : 51.7 w/al-fin Height : -1.5 Length : 91.7 Top Shape : Flower Head Anodized Pin : 30.0 Length : 78.0	STD 0.50



Piston Ring

OEM NO. ME202342
NPR : SDM31-095ZX

OEM Ring Groove	SIZE
Top : 2.35DK 2nd : 2.0 Oil : 4.0	STD 0.50



Cylinder Liner

OEM NO.

Liner&Sleeve	SIZE
In Diameter : 95.0 Out Diameter : 98.0 Total length : 175.0 Flange :	STD



Engine Bearing

MAIN : ME996520
CON.ROD : ME996534
T/W : ME200280
C/B :
BUSH : ME201016

SIZE
STD



Engine Valve

OEM NO. ME202687
IN 41.0 8.0 108.70
OEM NO. ME202688
EX 35.0 8.0 108.70

SIZE
STD

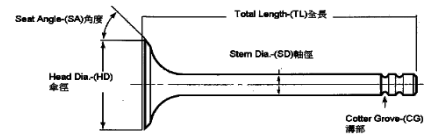

Valve Seat

OEM NO. ME200265
IN 43.0 35.9 6.0
OEM NO. ME200029
EX 37.0 30.0 6.0

SIZE
STD

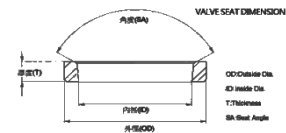

Valve Guide

OEM NO. ME201051
IN 44.0 8.0 13.0
OEM NO. ME201054
EX 51.0 8.0 13.0

SIZE
STD

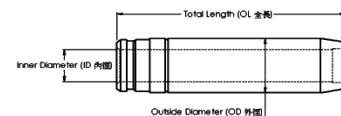

Gasket Set

OEM NO.



Piston kit-Set

OEM NO. ME200689

Piston

SIZE

 Comp : 51.7 w/al-fin Height : -3.0 oil-cooled Length : 91.7
 Top Shape : Flower
 Head Anodized
 Pin : 30.0 Length : 78.0

 STD
 0.50

Piston Ring

 OEM NO. ME202342
 NPR : SDM31-095ZX

OEM Ring Groove

SIZE

 Top : 2.35DK
 2nd : 2.0
 Oil : 4.0

 STD
 0.50

Cylinder Liner

OEM NO.

Liner&Sleeve

SIZE

 In Diameter : 95.0
 Out Diameter : 98.0
 Total length : 175.0
 Flange :

STD



Engine Bearing

 MAIN : ME996520
 CON.ROD : ME996534
 T/W : ME200280
 C/B :
 BUSH : ME201016

SIZE

STD



Engine Valve

 OEM NO. ME202687
 IN 41.0 8.0 108.5
 OEM NO. ME202688
 EX 35.0 8.0 108.5

SIZE

STD

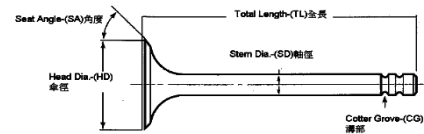

Valve Seat

 OEM NO. ME200265
 IN 43.0 35.9 6.0
 OEM NO. ME200029
 EX 37.0 30.0 6.0

SIZE

STD

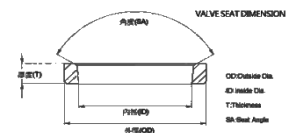

Valve Guide

 OEM NO. ME201051
 IN 44.0 8.0 13.0
 OEM NO. ME201054
 EX 51.0 8.0 13.0

SIZE

STD

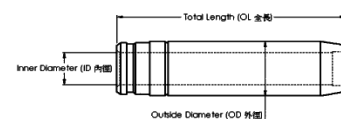

Gasket Set

OEM NO.



MITSUBISHI

4M40T

Application : TRUCK
Number of Cylinders 4
Cylinder dia. 95.0 MM
Swept Volume 2835 ccm

Piston kit-Set

OEM NO. ME203223



Piston

SIZE

Comp : 51.6 w/al-fin Height : -1.3 oil-cooled Length : 91.7
 Top Shape : Flower
 Head Anodized
 Pin : 30.0 Length : 78.0

STD
 0.50

Piston Ring

OEM NO. ME202148
 NPR : SDM31-140ZZ



OEM Ring Groove

SIZE

Top : 2.3DK
 2nd : 2.0
 Oil : 3.0

STD
 0.50

Cylinder Liner

OEM NO.



Liner&Sleeve

SIZE

In Diameter : 95.0
 Out Diameter : 98.0
 Total length : 175.0
 Flange :

STD

Engine Bearing

MAIN : ME996520
 CON.ROD : ME996534
 T/W : ME200280
 C/B :
 BUSH : ME201016



SIZE

STD

Engine Valve

OEM NO. ME202687
 IN 41.0 8.0 108.5
 OEM NO. ME202688
 EX 35.0 8.0 108.5

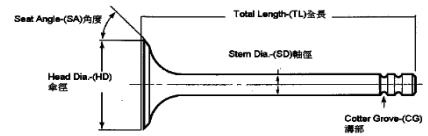

SIZE

STD

Valve Seat

OEM NO. ME200265
 IN 43.0 35.9 6.0
 OEM NO. ME200029
 EX 37.0 30.0 6.0

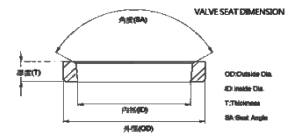

SIZE

STD

Valve Guide

OEM NO. ME201051
 IN 44.0 8.0 13.0
 OEM NO. ME201054
 EX 51.0 8.0 13.0

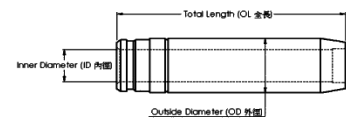

SIZE

STD

Gasket Set

OEM NO.



MITSUBISHI 4M41T

Application : TRUCK
Number of Cylinders 4
Cylinder dia. 98.5 MM
Swept Volume 3200 ccm

Piston kit-Set

OEM NO. ME191469/ME191470



Piston

SIZE

Comp : 47.2 w/al-fin Height : -20.8 oil-cooled
Length : 87.0 MOS2 Top Shape : Ø47.6
Head Anodized Direct Injection
Pin : 32.0 Length : 78.0

STD

Piston Ring

OEM NO. ME203533
NPR : SDM31-149ZZ



OEM Ring Groove

SIZE

Top : 2.35DK
2nd : 1.5
Oil : 3.0

STD

Cylinder Liner

OEM NO.



Liner&Sleeve

SIZE

In Diameter :
Out Diameter :
Total length :
Flange :

STD

Engine Bearing

MAIN :
CON.ROD :
T/W :
C/B :
BUSH :

SIZE



STD

Engine Valve

OEM NO. ME203101
IN 33.0 6.6 115.4
OEM NO. ME203102
EX 31.0 6.6 115.4

SIZE

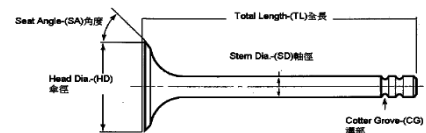

STD

Valve Seat

OEM NO.
IN
OEM NO.
EX

SIZE

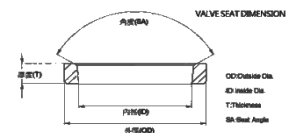

STD

Valve Guide

OEM NO. ME203044
IN 54.0 6.6 12.0
OEM NO. ME203036
EX 47.0 6.6 12.0

SIZE

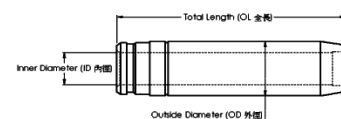

STD

Gasket Set

OEM NO.



MITSUBISHI

4M42-4AT2

Application : TRUCK
Number of Cylinders 4
Cylinder dia. 95.0 MM
Swept Volume 2977ccm

Piston kit-Set

OEM NO. ME190903/ME190906



Piston

SIZE

Comp : 47.0 w/al-fin Height : -18.3 oil-cooled Length : 87.0
Top Shape : Ø47.6
Direct Injection
Pin : 32.0 Length : 80.0

STD

Piston Ring

OEM NO. ME190317
NPR : SDM31-155ZZ



OEM Ring Groove

SIZE

Top : 2.358DK
2nd : 2.0
Oil : 3.0

STD

Cylinder Liner

OEM NO.



Liner&Sleeve

SIZE

In Diameter :
Out Diameter :
Total length :
Flange :

STD

Engine Bearing

MAIN :
CON.ROD :
T/W :
C/B :
BUSH :



SIZE

STD

Engine Valve

OEM NO. ME190286
IN 30.0 6.6 115.5
OEM NO. ME190287
EX 28.0 6.6 115.5

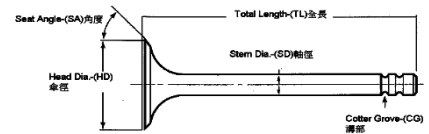

SIZE

STD

Valve Seat

OEM NO.
IN
OEM NO.
EX

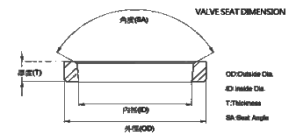

SIZE

STD

Valve Guide

OEM NO. ME203044
IN 54.0 6.6 12.0
OEM NO. ME203036
EX 47.0 6.6 12.0

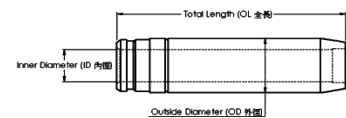

SIZE

STD

Gasket Set

OEM NO.



MITSUBISHI 4M42T

Application : TRUCK
Number of Cylinders 4
Cylinder dia. 95.0 MM
Swept Volume 2977ccm

Piston kit-Set

OEM NO. ME194895

Piston	SIZE
Comp : 51.0 w/al-fin Height : -17.2 oil-cooled Length : 87.0 MOS2 Top Shape : Ø55.5 Direct Injection Pin : 32.0 Length : 79.0	STD

Piston Ring

OEM NO. ME190317
NPR : SDM31-155ZZ

OEM Ring Groove	SIZE
Top : 2.358DK 2nd : 2.0 Oil : 3.0	STD



Cylinder Liner

OEM NO.

Liner&Sleeve	SIZE
In Diameter : Out Diameter : Total length : Flange :	STD



Engine Bearing

MAIN :	SIZE
CON.ROD : T/W : C/B : BUSH :	STD



Engine Valve

OEM NO. ME190286 IN 30.0 6.6 115.5 OEM NO. ME190287 EX 28.0 6.6 115.5	SIZE
	STD

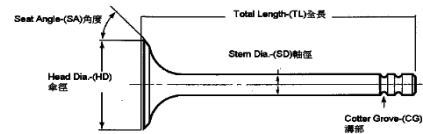

Valve Seat

OEM NO. IN OEM NO. EX	SIZE
	STD

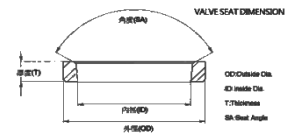

Valve Guide

OEM NO. ME203044 IN 54.0 6.6 12.0 OEM NO. ME203036 EX 47.0 6.6 12.0	SIZE
	STD

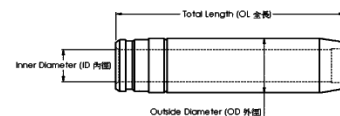

Gasket Set

OEM NO.



Piston kit-Set

OEM NO. ME193937/ME193940



Piston

SIZE

Comp : 51.1 w/al-fin Height : -16.8 oil-cooled
 Length : 77.1 MOS2 Top Shape : Ø55.5
 Direct Injection
 Pin : 32.0 Length : 80.0

STD

Piston Ring

OEM NO. ME190317
 NPR : SDM31-155ZZ

OEM Ring Groove

SIZE

Top : 2.358DK
 2nd : 2.0
 Oil : 3.0

STD



Cylinder Liner

OEM NO.

Liner&Sleeve

SIZE

In Diameter :
 Out Diameter :
 Total length :
 Flange :

STD



Engine Bearing

MAIN :
 CON.ROD :
 T/W :
 C/B :
 BUSH :

SIZE

STD



Engine Valve

OEM NO. ME190286
 IN 30.0 6.6 115.5
 OEM NO. ME190287
 EX 28.0 6.6 115.5

SIZE

STD

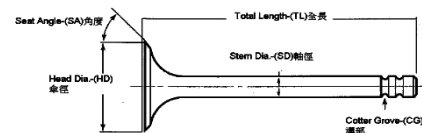

Valve Seat

OEM NO.
 IN
 OEM NO.
 EX

SIZE

STD

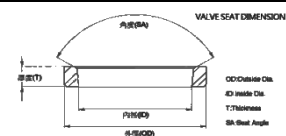

Valve Guide

OEM NO. ME203044
 IN 54.0 6.6 12.0
 OEM NO. ME203036
 EX 47.0 6.6 12.0

SIZE

STD

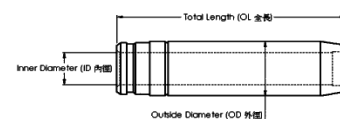

Gasket Set

OEM NO.



MITSUBISHI

4M50T

Application : TRUCK
 Number of Cylinders 4
 Cylinder dia. 114.0 MM
 Swept Volume 4899 ccm

Piston kit-Set

OEM NO. ME224532

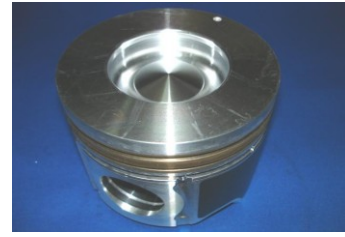

Piston

SIZE

Comp : 59.2 w/al-fin Height : -20.9 oil-cooled
 Length : 99.2 MOS2 Top Shape : Ø60.4
 Direct Injection
 Pin : 38.0 Length : 93.0

STD

Piston Ring

OEM NO.

NPR :



OEM Ring Groove

SIZE

Top : 2.806DK
 2nd : 2.0
 Oil : 4.0

STD

Cylinder Liner

OEM NO.



Liner&Sleeve

SIZE

In Diameter :
 Out Diameter :
 Total length :
 Flange :

STD

Engine Bearing

MAIN :

CON.ROD :

T/W :

C/B :

BUSH :

SIZE



STD

Engine Valve

OEM NO. EVMI-124-I

IN 36.0 8.0 139.8

OEM NO. EVMI-124-E

EX 36.0 8.0 139.8

SIZE

STD

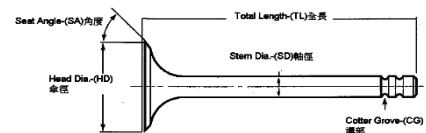

Valve Seat

OEM NO.

IN

OEM NO.

EX

SIZE

STD

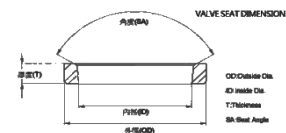

Valve Guide

OEM NO.

IN

OEM NO.

EX

SIZE

STD

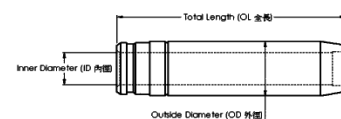

Gasket Set

OEM NO.



Piston kit-Set

OEM NO. ME240047

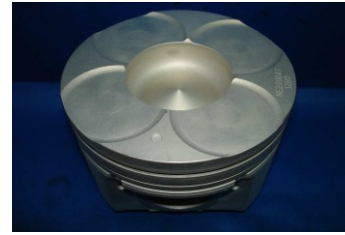

Piston

SIZE

Comp : 59.2 w/al-fin Height : -23.5 Length : 99.25
 Top Shape : Ø53.3
 Direct Injection
 Pin : 34.0 Length : 84.0

STD

Piston Ring

OEM NO. ME995591

NPR :



OEM Ring Groove

SIZE

Top : 3.0
 2nd : 2.0
 Oil : 3.0

STD

Cylinder Liner

OEM NO.



Liner&Sleeve

SIZE

In Diameter :
 Out Diameter :
 Total length :
 Flange :

STD

Engine Bearing

MAIN :
 CON.ROD :
 T/W :
 C/B :
 BUSH :

SIZE



STD

Engine Valve

OEM NO. ME240460/748
 IN 40.0 8.0 141.5
 OEM NO. ME240461
 EX 40.0 8.0 141.5

SIZE

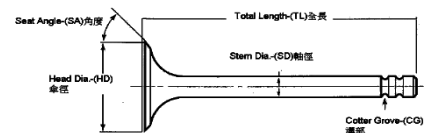

STD

Valve Seat

OEM NO.
 IN
 OEM NO.
 EX

SIZE

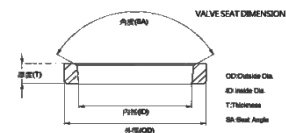

STD

Valve Guide

OEM NO. EGMI-43-Z
 IN/EX 75.0 8.0 13.0

SIZE

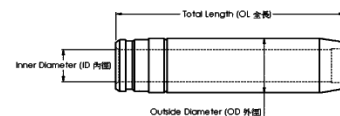

STD

Gasket Set

OEM NO.



MITSUBISHI 4D56T CRDI NEW

Application : TRUCK
Number of Cylinders 4
Cylinder dia. 91.1 MM
Swept Volume 2477ccm

Piston kit-Set

OEM NO. 1110A593(R) / 1110A594(L)

Piston	SIZE
Comp : 48.25 w/al-fin Height : -19.2 oil-cooled Length : 78.3 MOS2 Top Shape : Ø44.0 Direct Injection Head Anodized Pin : 32.0 Length : 75.0	STD



Piston Ring

OEM NO. MD050390
NPR : SDM31-038ZX

OEM Ring Groove	SIZE
Top : 2.5HK 2nd : 2.0 Oil : 4.0	STD



Cylinder Liner

OEM NO.

Liner&Sleeve	SIZE
In Diameter : Out Diameter : Total length : Flange :	STD



Engine Bearing

	SIZE
MAIN : CON.ROD : T/W : C/B : BUSH :	STD



Engine Valve

	SIZE
OEM NO. MN176597 IN 31.6 6.0 107.7 OEM NO. MN176598 EX 27.5 6.0 108	STD

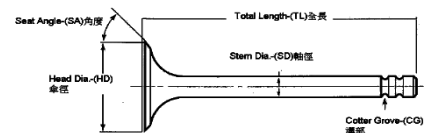

Valve Seat

	SIZE
OEM NO. IN OEM NO. EX	STD

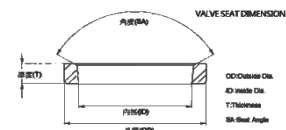

Valve Guide

	SIZE
OEM NO. 1010A109 IN 45.2 6.0 11.1 OEM NO. 1011A074 EX 48.2 6.0 11.1	STD

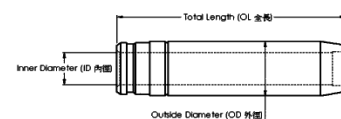

Gasket Set

OEM NO.



Piston kit-Set

OEM NO. MD304850

Piston	SIZE
Comp : 48.7 w/al-fin Height : -2.6 Length : 88.7 Top Shape : Flower Pin : 29.0 Length : 75.0	STD 0.50



Piston Ring

OEM NO. MD050390
NPR : SDM31-038ZX

OEM Ring Groove	SIZE
Top : 2.5HK 2nd : 2.0 Oil : 4.0	STD 0.50



Cylinder Liner

OEM NO. MD050430

Liner&Sleeve	SIZE
In Diameter : 91.1 Out Diameter : 94.1 Total length : 165.0 Flange :	STD



Engine Bearing

MAIN : MD050360
CON.ROD : MD026430
T/W :
C/B :
BUSH : MD050009

SIZE

STD



Engine Valve

OEM NO. MD198403
IN 40.0 8.0 130.0
OEM NO. MD198405
EX 34.0 8.0 130.0

SIZE

STD

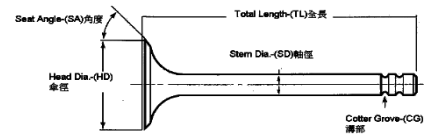

Valve Seat

OEM NO. MD050514
IN 43.5 36.0 7.2
OEM NO. MD050517
EX 37.5 30.0 7.2

SIZE

STD

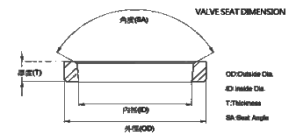

Valve Guide

OEM NO. MD050523
IN 71.0 8.0 13.0
OEM NO. MD050527
EX 74.0 8.0 13.0

SIZE

STD

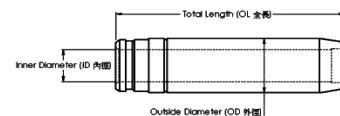

Gasket Set

OEM NO.



MITSUBISHI 4D56T NEW

Application : TRUCK
Number of Cylinders 4
Cylinder dia. 91.1 MM
Swept Volume 2476 ccm

Piston kit-Set

OEM NO. MD304853(R) / MD304859(L)

Piston	SIZE
Comp : 48.7 w/al-fin Height : -2.6 oil-cooled Length : 88.7 Top Shape : Flower Pin : 29.0 Length : 75.0	STD 0.50



Piston Ring

OEM NO. MD050390
NPR : SDM31-038ZX

OEM Ring Groove	SIZE
Top : 2.5HK 2nd : 2.0 Oil : 4.0	STD 0.50



Cylinder Liner

OEM NO. MD050430

Liner&Sleeve	SIZE
In Diameter : 91.1 Out Diameter : 94.1 Total length : 165.0 Flange :	STD



Engine Bearing

MAIN : MD050360
CON.ROD : MD026430
T/W :
C/B :
BUSH : MD050009

SIZE
STD



Engine Valve

OEM NO. MD198403
IN 40.0 8.0 130.0
OEM NO. MD198405
EX 34.0 8.0 130.0

SIZE
STD

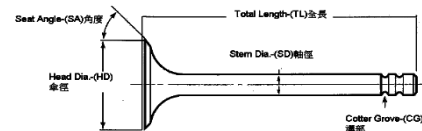

Valve Seat

OEM NO. MD050514
IN 43.5 36.0 7.2
OEM NO. MD050517
EX 37.5 30.0 7.2

SIZE
STD

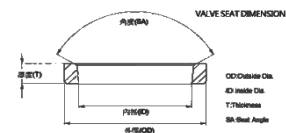

Valve Guide

OEM NO. MD050523
IN 71.0 8.0 13.0
OEM NO. MD050527
EX 74.0 8.0 13.0

SIZE
STD

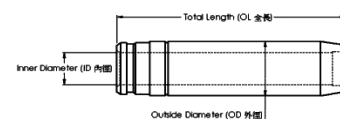

Gasket Set

OEM NO.



MITSUBISHI 4D56T NEW

Application :
Number of Cylinders 4
Cylinder dia. 91.1 MM
Swept Volume 2476 ccm

Piston kit-Set

OEM NO. MD304853 (R) / MD304859 (L)



Piston	SIZE
Comp : 48.7 w/al-fin Height : -2.6 oil-cooled Length : 88.7 Top Shape : Flower Pin : 29.0 Length : 75.0	STD 0.50

Piston Ring

OEM NO. MD050390
NPR : SDM31-038ZZ



OEM Ring Groove	SIZE
Top : 2.5K 2nd : 2.0 Oil : 4.0	STD 0.50

Cylinder Liner

OEM NO. MD050430



Liner&Sleeve	SIZE
In Diameter : 91.1 Out Diameter : 94.1 Total length : 165.0 Flange :	STD

Engine Bearing

MAIN : MD050360
CON.ROD : MD026430
T/W :
C/B :
BUSH : MD050009



	SIZE
	STD

Engine Valve

OEM NO. MD198403
IN 40.0 8.0 130.0
OEM NO.
EX 34.0 8.0 130.0

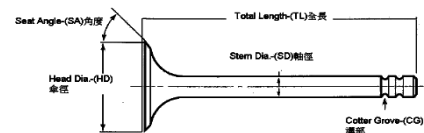

	SIZE
	STD

Valve Seat

OEM NO. MD050514
IN 43.5 36.0 7.2
OEM NO. MD050517
EX 37.5 30.0 7.2

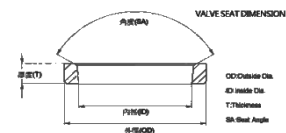

	SIZE
	STD

Valve Guide

OEM NO. MD050523
IN 71.0 8.0 13.0
OEM NO. MD050527
EX 74.0 8.0 13.0

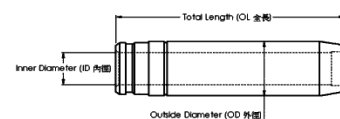

	SIZE
	STD

Gasket Set

OEM NO.



MITSUBISHI 4D68T

Application :
Number of Cylinders 4
Cylinder dia. 82.7 MM
Swept Volume 1998 ccm

Piston kit-Set

OEM NO. MD194157

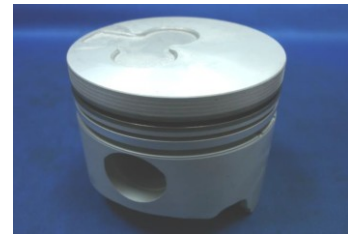

Piston

SIZE

Comp : 39.4 w/al-fin Height : -1.9 oil-cooled Length : 76.3
 Top Shape : Flower
 Pin : 25.0
 Length : 66.0

STD
0.50

Piston Ring

OEM NO. MD197187
 NPR : SDM31-151ZZ



OEM Ring Groove

SIZE

Top : 2.0HK
 2nd : 2.0HK
 Oil : 3.0

STD

Cylinder Liner

OEM NO.



Liner&Sleeve

SIZE

In Diameter :
 Out Diameter :
 Total length :
 Flange :

STD

Engine Bearing

MAIN :
 CON.ROD :
 T/W :
 C/B :
 BUSH :



SIZE

STD

Engine Valve

OEM NO. MD173602
 IN 36.1 8.0 113.9
 OEM NO. MD173603
 EX 32.1 8.0 113.6

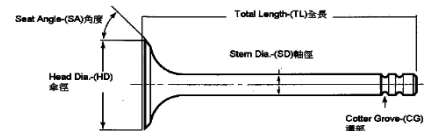

SIZE

STD

Valve Seat

OEM NO.
 IN
 OEM NO.
 EX

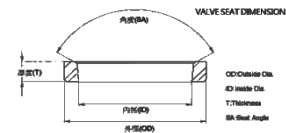

SIZE

STD

Valve Guide

OEM NO. MD076354
 IN 56.0 8.0 13.0
 OEM NO. MD076358
 EX 58.0 8.0 13.0

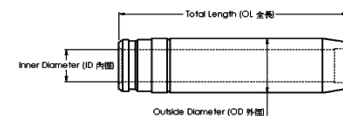

SIZE

STD

Gasket Set

OEM NO.



Piston kit-Set

OEM NO. 30617-57105



Piston	SIZE
Comp : 45.3 Height : -2.1 Length : 92.3 Top Shape : Flower Pin : 25.5 Length : 72.5	STD 0.50 1.00

Piston Ring

OEM NO.30615-51011
NPR : SDM31-010ZZ



OEM Ring Groove	SIZE
Top : 2.5 2nd : 2.0 Oil : 4.5	STD 0.50 1.00

Cylinder Liner

OEM NO. 30607-50301



Liner&Sleeve	SIZE
In Diameter : 84.0 Out Diameter : 87.0 Total length : 162.0 Flange :	STD

Engine Bearing

MAIN : 30609-11011
CON.ROD : 30619-22102
T/W :
C/B :
BUSH :



	SIZE
	STD

Engine Valve

OEM NO.30604-00102
IN 40.0 8.0 118.0
OEM NO.30604-01101
EX 31.0 8.0 118.0

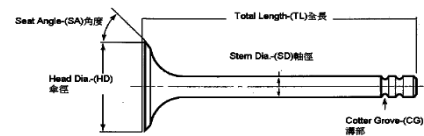

	SIZE
	STD

Valve Seat

OEM NO. 30601-10400
IN 41.0 37.0 5.0
OEM NO. 30601-10500
EX 33.0 28.0 5.0

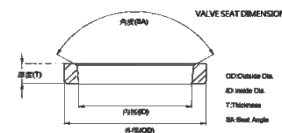

	SIZE
	STD

Valve Guide

OEM NO. 30601-20600
IN/EX 56.0 8.0 13.0

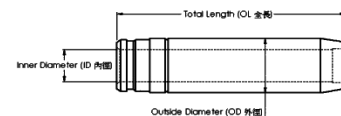

	SIZE
	STD

Gasket Set

OEM NO.



Piston kit-Set

OEM NO. 30617-60101



Piston	SIZE
Comp : 45.3 Height : -2.1 Length : 80.4 Top Shape : Flower Pin : 25.5 Length : 72.5	STD 0.50 1.00

Piston Ring

OEM NO.30615-51011
NPR : SDM31-010ZZ



OEM Ring Groove	SIZE
Top : 2.5 2nd : 2.0 Oil : 4.5	STD 0.50 1.00

Cylinder Liner

OEM NO. 30607-50301



Liner&Sleeve	SIZE
In Diameter : 84.0 Out Diameter : 87.0 Total length : 162.0 Flange :	STD

Engine Bearing

MAIN : 30609-11011
CON.ROD : 30619-22102
T/W :
C/B :
BUSH :



	SIZE
	STD

Engine Valve

OEM NO.30604-00102
IN 40.0 8.0 118.0
OEM NO.30604-01101
EX 31.0 8.0 118.0

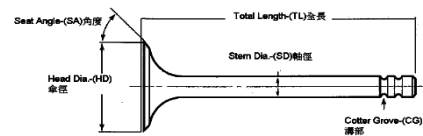

	SIZE
	STD

Valve Seat

OEM NO. 30601-10400
IN 41.0 37.0 5.0
OEM NO. 30601-10500
EX 33.0 28.0 5.0

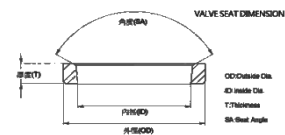

	SIZE
	STD

Valve Guide

OEM NO. 30601-20600
IN/EX 56.0 8.0 13.0

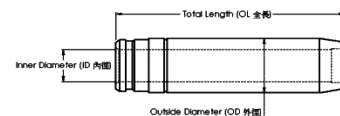

	SIZE
	STD

Gasket Set

OEM NO.



MITSUBISHI 4DR5

Application : TRUCK
Number of Cylinders 4
Cylinder dia. 92.0 MM
Swept Volume 2659 ccm

Piston kit-Set

OEM NO. 30617-00106/31617-00102

Piston	SIZE
Comp : 52.5 Height : -3.0 Length : 99.5 Top Shape : Flower Pin : 28.0 Length : 77.0	STD 0.50



Piston Ring

OEM NO. 30617-02012
NPR : SDM30-075ZZ

OEM Ring Groove	SIZE
Top : 2.5K 2nd : 2.0 3rd : 2.0 Oil : 4.5	STD 0.50



Cylinder Liner

OEM NO. 31607-02202

Liner&Sleeve	SIZE
In Diameter : 92.0 Out Diameter : 95.0 Total length : 176.0 Flange :	STD



Engine Bearing

MAIN : ME997202
CON.ROD : ME002019
T/W : 31309-08101
C/B : (F)31707-20700 (C)31707-13201 (R)31707-13301
BUSH : 31619-00700

SIZE
STD



Engine Valve

OEM NO. ME001142
IN 41.0 8.0 124.0
OEM NO. ME001143
EX 32.0 8.0 124.0

SIZE
STD

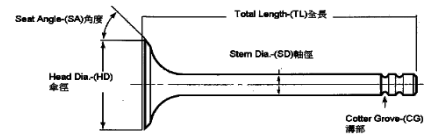

Valve Seat

OEM NO. ME001133
IN 43.0 38.0 5.7
OEM NO. ME001075
EX 34.0 29.0 5.7

SIZE
STD

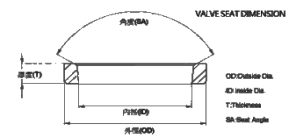

Valve Guide

OEM NO. 31301-10601
IN/EX 58.7 8.0 13.0

SIZE
STD

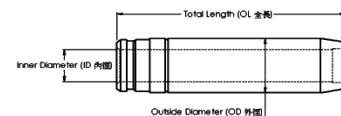

Gasket Set

OEM NO.



MITSUBISHI 4DR7

Application :
Number of Cylinders 4
Cylinder dia. 95.0 MM
Swept Volume 2835 ccm

Piston kit-Set

OEM NO. ME021861

Piston	SIZE
Comp : 52.6 w/al-fin Height : -2.3 Length : 94.6 Top Shape : Flower Pin : 28.0 Length : 78.0	STD 0.50



Piston Ring

OEM NO. ME997256
NPR : SDM31-095ZZ

OEM Ring Groove	SIZE
Top : 2.35K 2nd : 2.0 Oil : 4.0	STD 0.50



Cylinder Liner

OEM NO.

Liner&Sleeve	SIZE
In Diameter : 95.0 Out Diameter : 98.0 Total length : 175.0 Flange :	STD



Engine Bearing

MAIN : ME997202
CON.ROD : ME002019
T/W : 31309-08101
C/B : (F)31707-20700 (C)31707-13201 (R)31707-13301
BUSH : 31619-00700

SIZE
STD



Engine Valve

OEM NO. ME001142
IN 41.0 8.0 124.0
OEM NO. ME001143
EX 32.0 8.0 124.0

SIZE
STD

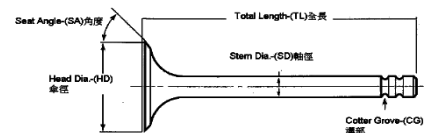

Valve Seat

OEM NO. ME001133
IN 43.0 38.0 5.7
OEM NO. ME001075
EX 34.0 29.0 5.7

SIZE
STD

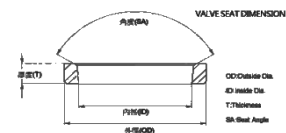

Valve Guide

OEM NO. 31301-10601
IN/EX 58.7 8.0 13.0

SIZE
STD

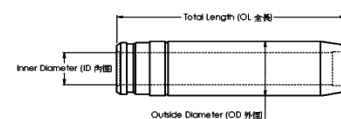

Gasket Set

OEM NO.



MITSUBISHI

4DR51

Application :
Number of Cylinders 4
Cylinder dia. 92.0 MM
Swept Volume 2659 ccm

Piston kit-Set

OEM NO. ME002044/ME002117

Piston	SIZE
Comp : 53.0 w/al-fin Height : -2.6 Length : 99.7 Top Shape : Flower Pin : 28.0 Length : 77.0	STD 0.50



Piston Ring

OEM NO. 31617-02012
 NPR : SDM30-075ZZ

OEM Ring Groove	SIZE
Top : 2.5K 2nd : 2.0 3rd : 2.0 Oil : 4.5	STD 0.50



Cylinder Liner

OEM NO. 31607-02202

Liner&Sleeve	SIZE
In Diameter : 92.0 Out Diameter : 95.0 Total length : 176.0 Flange :	STD



Engine Bearing

MAIN : ME997202
 CON.ROD : ME002019
 T/W : 31309-08101
 C/B : (F)31707-20700 (C)31707-13201 (R)31707-13301
 BUSH : 31619-00700

SIZE

STD



Engine Valve

OEM NO. ME001142
 IN 41.0 8.0 124.0
 OEM NO. ME001143
 EX 32.0 8.0 124.0

SIZE

STD

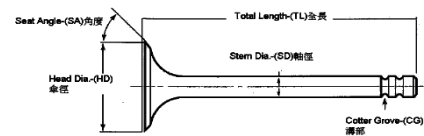

Valve Seat

OEM NO. ME001133
 IN 43.0 38.0 5.7
 OEM NO. ME001075
 EX 34.0 29.0 5.7

SIZE

STD

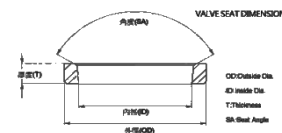

Valve Guide

OEM NO. 31301-10601
 IN/EX 58.7 8.0 13.0

SIZE

STD

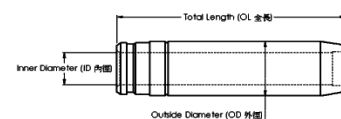

Gasket Set

OEM NO.



Piston kit-Set

OEM NO. ME241684

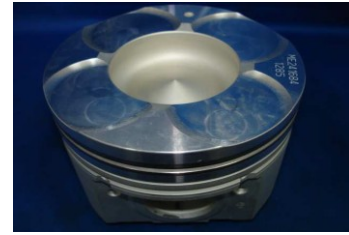

Piston

SIZE

Comp : 59.2 w/al-fin Height : -22.9 Length : 99.3
 Top Shape : Ø59.0
 Pin : 34.0
 Length : 84.0

STD

Piston Ring

OEM NO.
 NPR :



OEM Ring Groove

SIZE

Top : 3.0
 2nd : 2.0
 Oil : 4.0

STD

Cylinder Liner

OEM NO.



Liner&Sleeve

SIZE

In Diameter :
 Out Diameter :
 Total length :
 Flange :

STD

Engine Bearing

MAIN :
 CON.ROD :
 T/W :
 C/B :
 BUSH :



SIZE

STD

Engine Valve

OEM NO. ME240460/748
 IN 40.0 8.0 141.5
 OEM NO. ME240461
 EX 40.0 8.0 141.5

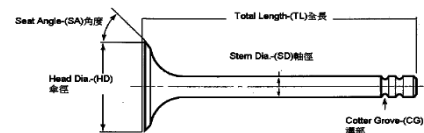

SIZE

STD

Valve Seat

OEM NO.
 IN
 OEM NO.
 EX

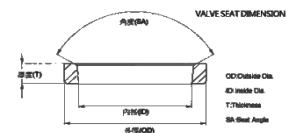

SIZE

STD

Valve Guide

OEM NO. EGMI-43-Z
 IN/EX 75.0 8.0 13.0

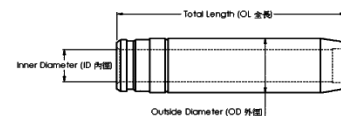

SIZE

STD

Gasket Set

OEM NO.



MITSUBISHI 4M51T

Application :
Number of Cylinders 4
Cylinder dia. 118.0 MM
Swept Volume 5249 ccm

Piston kit-Set

OEM NO. ME241686



Piston

SIZE

Comp : 59.2 w/al-fin Height : oil-cooled Length : 99.1
 Top Shape : Ø58.7
 Direct Injection
 Pin : 34.0 Length : 84.0

STD

Piston Ring

OEM NO.

NPR :



OEM Ring Groove

SIZE

Top : 3.0
 2nd : 2.0
 Oil : 4.0

STD

Cylinder Liner

OEM NO.

Liner&Sleeve

SIZE

In Diameter :
 Out Diameter :
 Total length :
 Flange :

STD



Engine Bearing

MAIN :

CON.ROD :

T/W :

C/B :

BUSH :

SIZE

STD



Engine Valve

OEM NO. ME240460/748

IN 40.0 8.0 141.5

OEM NO. ME240461

EX 40.0 8.0 141.5

SIZE

STD

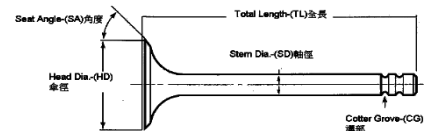

Valve Seat

OEM NO.

IN

OEM NO.

EX

SIZE

STD

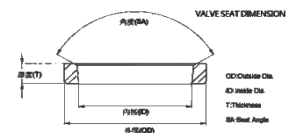

Valve Guide

OEM NO. EGMI-43-Z

IN/EX 75.0 8.0 13.0

SIZE

STD

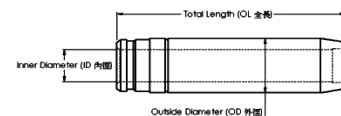

Gasket Set

OEM NO.



Piston kit-Set

OEM NO. ME032300/ME032303/ME032194

Piston	SIZE
Comp : 71.5 Height : Length : 131.0 Top Shape : Flower Pin : 38.0 Length : 90.0	STD

Piston Ring

OEM NO. ME032190
NPR : SDM31-006ZZ

OEM Ring Groove	SIZE
Top : 3.0K 2nd : 2.0 Oil : 5.0	STD



Cylinder Liner

OEM NO. ME031502

Liner&Sleeve	SIZE
In Diameter : 105.0 Out Diameter : 119.0 Total length : 205.8 Flange : 126.0*10.0+1.3	STD



Engine Bearing

MAIN : ME999199
CON.ROD : ME032518
T/W : ME031059
C/B :
BUSH : ME033943

SIZE
STD



Engine Valve

OEM NO. ME031938
IN 47.0 9.0 137.0
OEM NO. ME031940
EX 40.0 9.0 137.0

SIZE
STD

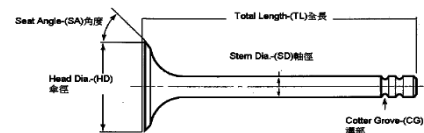

Valve Seat

OEM NO. ME031931/32
IN 49.0 40.0 6.8
OEM NO. ME031935/36
EX 42.0 36.0 6.8

SIZE
STD

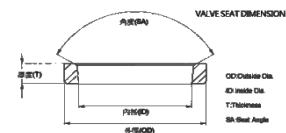

Valve Guide

OEM NO. ME031293
IN 64.0 9.0 15.0
OEM NO. ME031888
EX 71.0 9.0 15.0

SIZE
STD

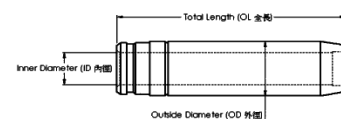

Gasket Set

OEM NO.



MITSUBISHI 6D10

Application : TRUCK
Number of Cylinders 6
Cylinder dia. 105.0 MM
Swept Volume 5974 ccm

Piston kit-Set

OEM NO. ME032194/ME032300/ME032303

Piston	SIZE
Comp : 70.9 Height : -9.7 Length : 130.9 Top Shape : Flower Pin : 38.0 Length : 90.0	STD



Piston Ring

OEM NO. ME032190
NPR : SDM31-006ZZ

OEM Ring Groove	SIZE
Top : 3.0K 2nd : 2.0 Oil : 5.0	STD



Cylinder Liner

OEM NO. ME031502

Liner&Sleeve	SIZE
In Diameter : 105.0 Out Diameter : 119.0 Total length : 205.8 Flange : 126.0*10.0+1.3	STD



Engine Bearing

MAIN : ME999199
CON.ROD : ME032518
T/W : ME031059
C/B :
BUSH : ME033943

SIZE
STD



Engine Valve

OEM NO. ME031938
IN 47.0 9.0 137.0
OEM NO. ME031940
EX 40.0 9.0 137.0

SIZE
STD

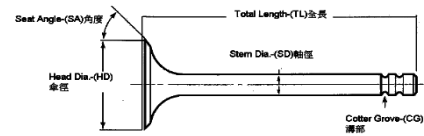

Valve Seat

OEM NO. ME031931/32
IN 49.0 40.0 6.8
OEM NO. ME031935/36
EX 42.0 36.0 6.8

SIZE
STD

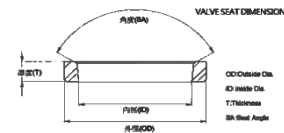

Valve Guide

OEM NO. ME031293
IN 64.0 9.0 15.0
OEM NO. ME031888
EX 71.0 9.0 15.0

SIZE
STD

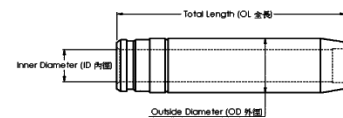

Gasket Set

OEM NO.



Piston kit-Set

OEM NO. ME032301

Piston	SIZE
Comp : 70.7 Height : -10.0 Length : 130.7 Top Shape : Flower Pin : 38.0 Length : 90.0	STD



Piston Ring

OEM NO. ME032190
NPR : SDM31-006ZZ

OEM Ring Groove	SIZE
Top : 3.0K 2nd : 2.0 Oil : 5.0	STD



Cylinder Liner

OEM NO. ME031505

Liner&Sleeve	SIZE
In Diameter : 105.0 Out Diameter : 119.0 Total length : 208.3 Flange : 126.0*10.0+1.3	STD



Engine Bearing

MAIN : ME999199
CON.ROD : ME032518
T/W : ME031059
C/B :
BUSH : ME033943

SIZE
STD



Engine Valve

OEM NO. ME031938
IN 47.0 9.0 137.0
OEM NO. ME031940
EX 40.0 9.0 137.0

SIZE
STD

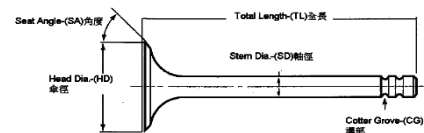

Valve Seat

OEM NO. ME031931/32
IN 49.0 40.0 6.8
OEM NO. ME031935/36
EX 42.0 36.0 6.8

SIZE
STD

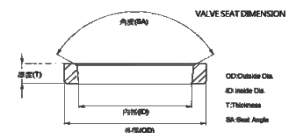

Valve Guide

OEM NO. ME031293
IN 64.0 9.0 15.0
OEM NO. ME031888
EX 71.0 9.0 15.0

SIZE
STD

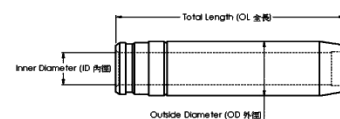

Gasket Set

OEM NO.



MITSUBISHI 6D14-2AT

Application : TRUCK BUS
Number of Cylinders 6
Cylinder dia. 110.0 MM
Swept Volume 6557 ccm

Piston kit-Set

OEM NO. ME072022

Piston

SIZE

Comp : 71.1 w/al-fin Height : Length : 116.0
Top Shape : Ø57.0
Direct Injection
Pin : 38.0 Length : 90.0

STD



Piston Ring

OEM NO. ME032071

NPR : SDM31-007ZZ

OEM Ring Groove

SIZE

Top : 3.0K
2nd : 2.5
Oil : 5.0

STD



Cylinder Liner

OEM NO. ME071198

Liner&Sleeve

SIZE

In Diameter : 110.0
Out Diameter : 122.0
Total length : 211.0
Flange : 131.0*10.0+1.5

STD



Engine Bearing

MAIN : ME999199

CON.ROD : ME032518

T/W : ME031059

C/B :

BUSH : ME033943

SIZE

STD



Engine Valve

OEM NO. ME031938

IN 47.0 9.0 137.0

OEM NO. ME031940

EX 40.0 9.0 137.0

SIZE

STD

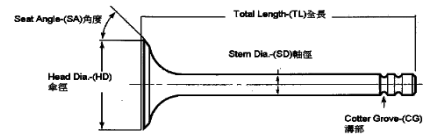

Valve Seat

OEM NO. ME031931/32

IN 49.0 40.0 6.8

OEM NO. ME031935/36

EX 42.0 36.0 6.8

SIZE

STD

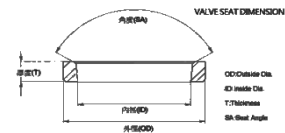

Valve Guide

OEM NO. ME031293

IN 64.0 9.0 15.0

OEM NO. ME031888

EX 71.0 9.0 15.0

SIZE

STD

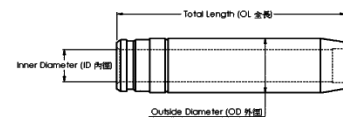

Gasket Set

OEM NO.



MITSUBISHI 6D14-2AT

Application : TRUCK BUS
Number of Cylinders 6
Cylinder dia. 110.0 MM
Swept Volume 6557 ccm

Piston kit-Set

OEM NO. ME072170

Piston	SIZE
Comp : 71.1 w/al-fin Height : -20.8 Length : 116.0 Top Shape : Ø55.7 Direct Injection Pin : 38.0 Length : 90.0	STD



Piston Ring

OEM NO. ME999952
NPR : SDM31-089ZZ

OEM Ring Groove	SIZE
Top : 3.0 2nd : 2.5 Oil : 4.0	STD



Cylinder Liner

OEM NO. ME071198

Liner&Sleeve	SIZE
In Diameter : 110.0 Out Diameter : 122.0 Total length : 211.0 Flange : 131.0*10.0+1.5	STD



Engine Bearing

MAIN : ME999199
CON.ROD : ME032518
T/W : ME031059
C/B :
BUSH : ME033943

SIZE
STD



Engine Valve

OEM NO. ME031938
IN 47.0 9.0 137.0
OEM NO. ME031940
EX 40.0 9.0 137.0

SIZE
STD

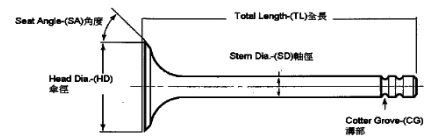

Valve Seat

OEM NO. ME031931/32
IN 49.0 40.0 6.8
OEM NO. ME031935/36
EX 42.0 36.0 6.8

SIZE
STD

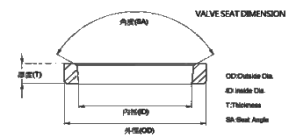

Valve Guide

OEM NO. ME031293
IN 64.0 9.0 15.0
OEM NO. ME031888
EX 71.0 9.0 15.0

SIZE
STD

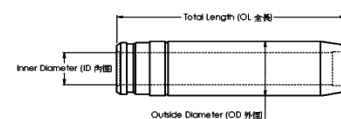

Gasket Set

OEM NO.



MITSUBISHI 6D14-2AT

Application : TRUCK BUS
Number of Cylinders 6
Cylinder dia. 110.0 MM
Swept Volume 6557 ccm

Piston kit-Set

OEM NO. ME072317

Piston

SIZE

Comp : 71.1 w/al-fin Height : Length : 116.0
Top Shape : Ø55.6
Direct Injection
Pin : 38.0 Length : 90.0

STD

Piston Ring

OEM NO. ME032071

NPR : SDM31-007ZZ

OEM Ring Groove

SIZE

Top : 3.0K
2nd : 2.5
Oil : 5.0

STD



Cylinder Liner

OEM NO. ME071198

Liner&Sleeve

SIZE

In Diameter : 110.0
Out Diameter : 122.0
Total length : 211.0
Flange : 131.0*10.0+1.5

STD



Engine Bearing

MAIN : ME999199
CON.ROD : ME032518
T/W : ME031059
C/B :
BUSH : ME033943

SIZE

STD



Engine Valve

OEM NO. ME031938
IN 47.0 9.0 137.0
OEM NO. ME031940
EX 40.0 9.0 137.0

SIZE

STD

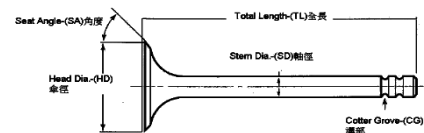

Valve Seat

OEM NO. ME031931/32
IN 49.0 40.0 6.8
OEM NO. ME031935/36
EX 42.0 36.0 6.8

SIZE

STD

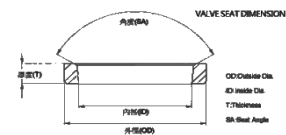

Valve Guide

OEM NO. ME031293
IN 64.0 9.0 15.0
OEM NO. ME031888
EX 71.0 9.0 15.0

SIZE

STD

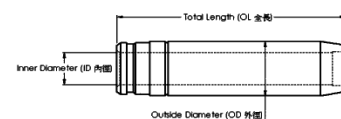

Gasket Set

OEM NO.



MITSUBISHI 6D14-3AT

Application : TRUCK BUS
Number of Cylinders 6
Cylinder dia. 110.0 MM
Swept Volume 6557 ccm

Piston kit-Set

OEM NO. ME072047

Piston	SIZE
Comp : 71.1 w/al-fin Height : -21.6 Length : 116.0 Top Shape : Ø58.5 Direct Injection Pin : 38.0 Length : 90.0	STD



Piston Ring

OEM NO. ME997465
NPR : SDM31-122ZZ

OEM Ring Groove	SIZE
Top : 2.8DK 2nd : 2.5 Oil : 4.0	STD



Cylinder Liner

OEM NO. ME071198

Liner&Sleeve	SIZE
In Diameter : 110.0 Out Diameter : 122.0 Total length : 211.0 Flange : 131.0*10.0+1.5	STD



Engine Bearing

MAIN : ME995344
CON.ROD : ME996243
T/W : ME130226
C/B :
BUSH : ME072128

SIZE
STD



Engine Valve

OEM NO. ME031938
IN 47.0 9.0 137.0
OEM NO. ME031940
EX 40.0 9.0 137.0

SIZE
STD

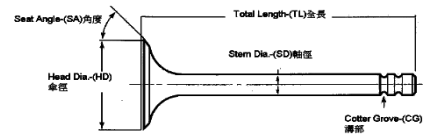

Valve Seat

OEM NO. ME031931/32
IN 49.0 40.0 6.8
OEM NO. ME031935/36
EX 42.0 36.0 6.8

SIZE
STD

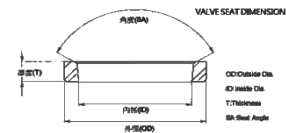

Valve Guide

OEM NO. ME031293
IN 64.0 9.0 15.0
OEM NO. ME031888
EX 71.0 9.0 15.0

SIZE
STD

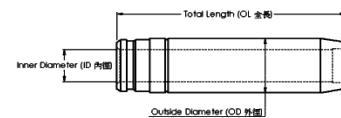

Gasket Set

OEM NO.



Piston kit-Set

OEM NO. ME032619/ME032216



Piston

SIZE

Comp : 70.8 w/al-fin Height : -21.5 Length : 115.9
Top Shape : Ø60.5
Direct Injection
Pin : 38.0 Length : 90.0

STD

Piston Ring

OEM NO. ME032071
NPR : SDM31-007ZZ



OEM Ring Groove

SIZE

Top : 3.0K
2nd : 2.5
Oil : 5.0

STD

Cylinder Liner

OEM NO. ME031463



Liner&Sleeve

SIZE

In Diameter : 110.0
Out Diameter : 122.0
Total length : 206.0
Flange : 130.6*10.0+1.5

STD

Engine Bearing

MAIN : ME999199
CON.ROD : ME032518
T/W : ME031059
C/B :
BUSH : ME033943

SIZE



STD

Engine Valve

OEM NO. ME031938
IN 47.0 9.0 137.0
OEM NO. ME031940
EX 40.0 9.0 137.0

SIZE

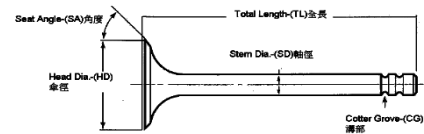

STD

Valve Seat

OEM NO. ME031931/32
IN 49.0 40.0 6.8
OEM NO. ME031935/36
EX 42.0 36.0 6.8

SIZE

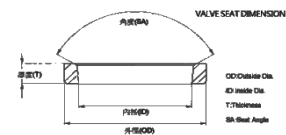

STD

Valve Guide

OEM NO. ME031293
IN 64.0 9.0 15.0
OEM NO. ME031888
EX 71.0 9.0 15.0

SIZE

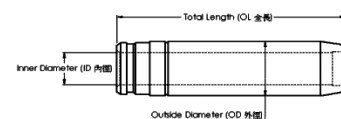

STD

Gasket Set

OEM NO.



MITSUBISHI

6D14-1A

Application : TRUCK BUS
Number of Cylinders 6
Cylinder dia. 110.0 MM
Swept Volume 6557 ccm

Piston kit-Set

OEM NO. ME032626

Piston

SIZE

Comp : 70.8 w/al-fin Height : -22.7 Length : 115.8
 Top Shape : Ø57.0
 Direct Injection
 Pin : 38.0 Length : 90.0

STD



Piston Ring

OEM NO. ME032071

NPR : SDM31-007ZZ

OEM Ring Groove

SIZE

Top : 3.0K
 2nd : 2.5
 Oil : 5.0

STD



Cylinder Liner

OEM NO. ME031463

Liner&Sleeve

SIZE

In Diameter : 110.0
 Out Diameter : 122.0
 Total length : 206.0
 Flange : 130.6*10.0+1.5

STD



Engine Bearing

MAIN : ME999199

CON.ROD : ME032518

T/W : ME031059

C/B :

BUSH : ME033943

SIZE

STD



Engine Valve

OEM NO. ME031938

IN 47.0 9.0 137.0

OEM NO. ME031940

EX 40.0 9.0 137.0

SIZE

STD

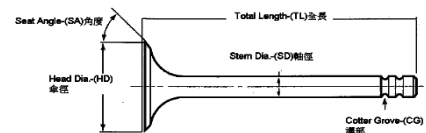

Valve Seat

OEM NO. ME031931/32

IN 49.0 40.0 6.8

OEM NO. ME031935/36

EX 42.0 36.0 6.8

SIZE

STD

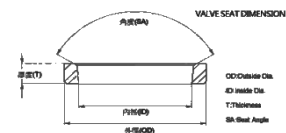

Valve Guide

OEM NO. ME031293

IN 64.0 9.0 15.0

OEM NO. ME031888

EX 71.0 9.0 15.0

SIZE

STD

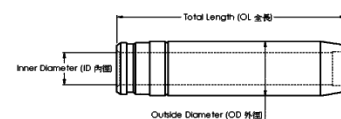

Gasket Set

OEM NO.



Piston kit-Set

OEM NO. ME070394

Piston

SIZE

Comp : 70.8 w/al-fin Height : Length : 115.8
Top Shape : Ø59.0
Direct Injection
Pin : 38.0 Length : 90.0

STD

Piston Ring

OEM NO. ME032071
NPR : SDM31-007ZZ

OEM Ring Groove

SIZE

Top : 3.0K
2nd : 2.5
Oil : 5.0

STD



Cylinder Liner

OEM NO. ME031463

Liner&Sleeve

SIZE

In Diameter : 110.0
Out Diameter : 122.0
Total length : 206.0
Flange : 130.6*10.0+1.5

STD



Engine Bearing

MAIN : ME999199
CON.ROD : ME032518
T/W : ME031059
C/B :
BUSH : ME033943

SIZE

STD



Engine Valve

OEM NO. ME031938
IN 47.0 9.0 137.0
OEM NO. ME031940
EX 40.0 9.0 137.0

SIZE

STD

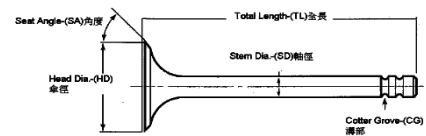

Valve Seat

OEM NO. ME031931/32
IN 49.0 40.0 6.8
OEM NO. ME031935/36
EX 42.0 36.0 6.8

SIZE

STD

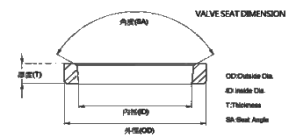

Valve Guide

OEM NO. ME031293
IN 64.0 9.0 15.0
OEM NO. ME031888
EX 71.0 9.0 15.0

SIZE

STD

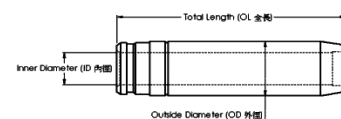

Gasket Set

OEM NO.



MITSUBISHI 6D14T

Application : TRUCK BUS
Number of Cylinders 6
Cylinder dia. 110.0 MM
Swept Volume 6557 ccm

Piston kit-Set

OEM NO. ME032569

Piston

SIZE

Comp : 71.1 w/al-fin Height : -21.6 Length : 116.2
Top Shape : Ø61.5
Direct Injection
Pin : 38.0 Length : 90.0

STD



Piston Ring

OEM NO. ME032071
NPR : SDM31-007ZZ

OEM Ring Groove

SIZE

Top : 3.0K
2nd : 2.5
Oil : 5.0

STD



Cylinder Liner

OEM NO. ME031463

Liner&Sleeve

SIZE

In Diameter : 110.0
Out Diameter : 122.0
Total length : 206.0
Flange : 130.6*10.0+1.5

STD



Engine Bearing

MAIN : ME999199
CON.ROD : ME032518
T/W : ME031059
C/B :
BUSH : ME033943

SIZE

STD



Engine Valve

OEM NO. ME031938
IN 47.0 9.0 137.0
OEM NO. ME031940
EX 40.0 9.0 137.0

SIZE

STD

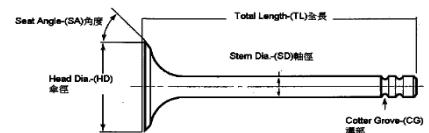

Valve Seat

OEM NO. ME031931/32
IN 49.0 40.0 6.8
OEM NO. ME031935/36
EX 42.0 36.0 6.8

SIZE

STD

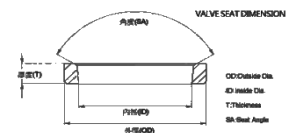

Valve Guide

OEM NO. ME031293
IN 64.0 9.0 15.0
OEM NO. ME031888
EX 71.0 9.0 15.0

SIZE

STD

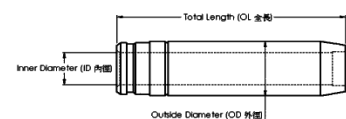

Gasket Set

OEM NO.



MITSUBISHI

6D14T

Application : TRUCK BUS
Number of Cylinders 6
Cylinder dia. 110.0 MM
Swept Volume 6557 ccm

Piston kit-Set

OEM NO. ME032742

Piston

SIZE

Comp : 71.1 w/al-fin Height : -20.5 Length : 116.0
 Top Shape : Ø61.8
 Direct Injection
 Pin : 38.0 Length : 90.0

STD



Piston Ring

OEM NO. ME032071

NPR : SDM31-007ZZ

OEM Ring Groove

SIZE

Top : 3.0K
 2nd : 2.5
 Oil : 5.0

STD



Cylinder Liner

OEM NO. ME031463

Liner&Sleeve

SIZE

In Diameter : 110.0
 Out Diameter : 122.0
 Total length : 206.0
 Flange : 130.6*10.0+1.5

STD



Engine Bearing

MAIN : ME999199

CON.ROD : ME032518

T/W : ME031059

C/B :

BUSH : ME033943

SIZE

STD



Engine Valve

OEM NO. ME031938

IN 47.0 9.0 137.0

OEM NO. ME031940

EX 40.0 9.0 137.0

SIZE

STD

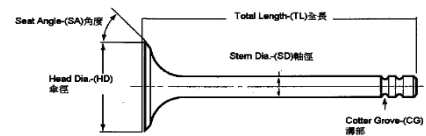

Valve Seat

OEM NO. ME031931/32

IN 49.0 40.0 6.8

OEM NO. ME031935/36

EX 42.0 36.0 6.8

SIZE

STD

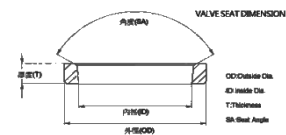

Valve Guide

OEM NO. ME031293

IN 64.0 9.0 15.0

OEM NO. ME031888

EX 71.0 9.0 15.0

SIZE

STD

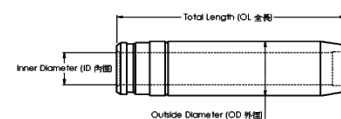

Gasket Set

OEM NO.



MITSUBISHI 6D15-3AT

Application : TRUCK BUS
Number of Cylinders 6
Cylinder dia. 113.0 MM
Swept Volume 6919 ccm

Piston kit-Set

OEM NO. ME072055

Piston	SIZE
Comp : 71.1 w/al-fin Height : -21.4 Length : 116.3 Top Shape : Ø58.5 Direct Injection Pin : 38.0 Length : 90.0	STD



Piston Ring

OEM NO. ME997466
NPR : SDM31-119ZZ

OEM Ring Groove	SIZE
Top : 2.8DK 2nd : 2.5 Oil : 4.0	STD



Cylinder Liner

OEM NO. ME071090

Liner&Sleeve	SIZE
In Diameter : 113.0 Out Diameter : 117.0 Total length : 206.0 Flange : 125.0*8.0+1.5	STD



Engine Bearing

MAIN : ME999199
CON.ROD : ME032518
T/W : ME031059
C/B :
BUSH : ME033943

SIZE
STD



Engine Valve

OEM NO. ME031937
IN 49.0 9.0 137.0
OEM NO. ME031939
EX 42.0 9.0 137.0

SIZE
STD

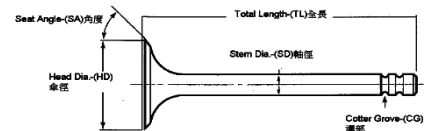

Valve Seat

OEM NO. ME031929/30
IN 51.0 44.2 6.8
OEM NO. ME031933/34
EX 44.0 38.0 6.8

SIZE
STD

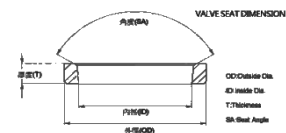

Valve Guide

OEM NO. ME031293
IN 64.0 9.0 15.0
OEM NO. ME031888
EX 71.0 9.0 15.0

SIZE
STD

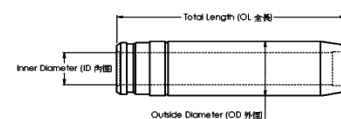

Gasket Set

OEM NO.



MITSUBISHI 6D15-3AT

Application : TRUCK BUS
Number of Cylinders 6
Cylinder dia. 113.0 MM
Swept Volume 6919 ccm

Piston kit-Set

OEM NO. ME072321

Piston	SIZE
Comp : 71.1 w/al-fin Height : -21.0 Length : 116.3 Top Shape : Ø58.5 Direct Injection Pin : 38.0 Length : 90.0	STD



Piston Ring

OEM NO. ME997466
NPR : SDM31-119ZZ

OEM Ring Groove	SIZE
Top : 2.8DK 2nd : 2.5 Oil : 4.0	STD



Cylinder Liner

OEM NO. ME071090

Liner&Sleeve	SIZE
In Diameter : 113.0 Out Diameter : 117.0 Total length : 206.0 Flange : 125.0*8.0+1.5	STD



Engine Bearing

MAIN : ME999199
CON.ROD : ME032518
T/W : ME031059
C/B :
BUSH : ME033943

SIZE
STD



Engine Valve

OEM NO. ME031937
IN 49.0 9.0 137.0
OEM NO. ME031939
EX 42.0 9.0 137.0

SIZE
STD

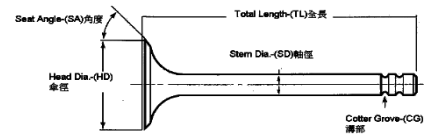

Valve Seat

OEM NO. ME031929/30
IN 51.0 44.2 6.8
OEM NO. ME031933/34
EX 44.0 38.0 6.8

SIZE
STD

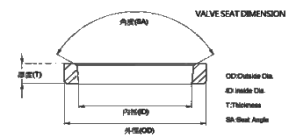

Valve Guide

OEM NO. ME031293
IN 64.0 9.0 15.0
OEM NO. ME031888
EX 71.0 9.0 15.0

SIZE
STD

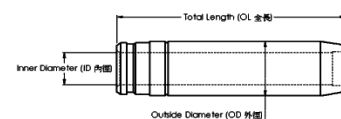

Gasket Set

OEM NO.



Piston kit-Set

OEM NO. ME032480

Piston

SIZE

Comp : 70.8 w/al-fin Height : -22.0 Length : 115.8
Top Shape : Ø56.5
Direct Injection
Pin : 38.0 Length : 90.0

STD

Piston Ring

OEM NO. ME032403
NPR : SDM31-073ZZ

OEM Ring Groove

SIZE

Top : 3.0K
2nd : 2.5
Oil : 5.0

STD



Cylinder Liner

OEM NO. ME031656

Liner&Sleeve

SIZE

In Diameter : 113.0
Out Diameter : 125.0
Total length : 206.0
Flange : 133.0*10.0+1.5

STD



Engine Bearing

MAIN : ME999199
CON.ROD : ME032518
T/W : ME031059
C/B :
BUSH : ME033943

SIZE

STD



Engine Valve

OEM NO. ME031937
IN 49.0 9.0 137.0
OEM NO. ME031939
EX 42.0 9.0 137.0

SIZE

STD

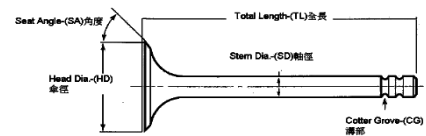

Valve Seat

OEM NO. ME031929/30
IN 51.0 44.2 6.8
OEM NO. ME031933/34
EX 44.0 38.0 6.8

SIZE

STD

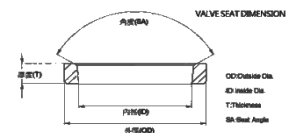

Valve Guide

OEM NO. ME031293
IN 64.0 9.0 15.0
OEM NO. ME031888
EX 71.0 9.0 15.0

SIZE

STD

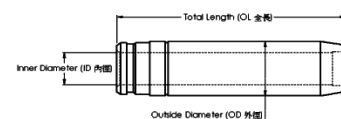

Gasket Set

OEM NO.



Piston kit-Set

OEM NO. ME032593

Piston

SIZE

 Comp : 70.8 w/al-fin Height : Length : 115.5
 Top Shape : Ø57.0
 Direct Injection
 Pin : 38.0 Length : 90.0

STD

Piston Ring

 OEM NO. ME032403
 NPR : SDM31-073ZZ

OEM Ring Groove

SIZE

 Top : 3.0K
 2nd : 2.5
 Oil : 5.0

STD



Cylinder Liner

OEM NO. ME031656

Liner&Sleeve

SIZE

 In Diameter : 113.0
 Out Diameter : 125.0
 Total length : 206.0
 Flange : 133.0*10.0+1.5

STD



Engine Bearing

 MAIN : ME999199
 CON.ROD : ME032518
 T/W : ME031059
 C/B :
 BUSH : ME033943

SIZE

STD



Engine Valve

 OEM NO. ME031937
 IN 49.0 9.0 137.0
 OEM NO. ME031939
 EX 42.0 9.0 137.0

SIZE

STD

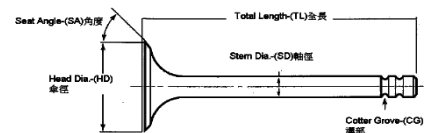

Valve Seat

 OEM NO. ME031929/30
 IN 51.0 44.2 6.8
 OEM NO. ME031933/34
 EX 44.0 38.0 6.8

SIZE

STD

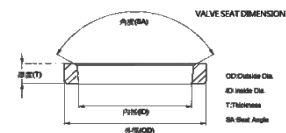

Valve Guide

 OEM NO. ME031293
 IN 64.0 9.0 15.0
 OEM NO. ME031888
 EX 71.0 9.0 15.0

SIZE

STD

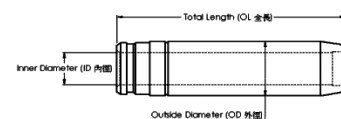

Gasket Set

OEM NO.



Piston kit-Set

OEM NO. ME032593



Piston

SIZE

Comp : 71.1 w/al-fin Height : -21.8 Length : 116.1
Top Shape : Ø57.0
Direct Injection
Pin : 38.0 Length : 90.0

STD

Piston Ring

OEM NO. ME032403
NPR : SDM31-073ZZ



OEM Ring Groove

SIZE

Top : 3.0K
2nd : 2.5
Oil : 5.0

STD

Cylinder Liner

OEM NO. ME031656



Liner&Sleeve

SIZE

In Diameter : 113.0
Out Diameter : 125.0
Total length : 206.0
Flange : 133.0*10.0+1.5

STD

Engine Bearing

MAIN : ME999199
CON.ROD : ME032518
T/W : ME031059
C/B :
BUSH : ME033943



SIZE

STD

Engine Valve

OEM NO. ME031937
IN 49.0 9.0 137.0
OEM NO. ME031939
EX 42.0 9.0 137.0

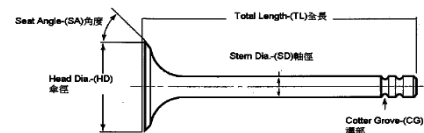

SIZE

STD

Valve Seat

OEM NO. ME031929/30
IN 51.0 44.2 6.8
OEM NO. ME031933/34
EX 44.0 38.0 6.8

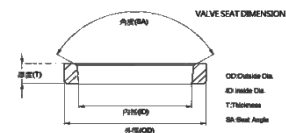

SIZE

STD

Valve Guide

OEM NO. ME031293
IN 64.0 9.0 15.0
OEM NO. ME031888
EX 71.0 9.0 15.0

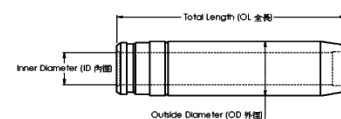

SIZE

STD

Gasket Set

OEM NO.



MITSUBISHI

6D15T

Application : TRUCK
Number of Cylinders 6
Cylinder dia. 113.0 MM
Swept Volume 6919 ccm

Piston kit-Set

OEM NO. ME032870

Piston	SIZE
Comp : 71.1 w/al-fin Height : -22.3 Length : 116.3 Top Shape : Ø59.0 Direct Injection Pin : 38.0 Length : 90.0	STD



Piston Ring

OEM NO. ME032403
 NPR : SDM31-073ZZ

OEM Ring Groove	SIZE
Top : 3.0K 2nd : 2.5 Oil : 5.0	STD



Cylinder Liner

OEM NO. ME031656

Liner&Sleeve	SIZE
In Diameter : 113.0 Out Diameter : 125.0 Total length : 206.0 Flange : 133.0*10.0+1.5	STD



Engine Bearing

MAIN : ME999199
 CON.ROD : ME032518
 T/W : ME031059
 C/B :
 BUSH : ME033943

SIZE
 STD



Engine Valve

OEM NO. ME031937
 IN 49.0 9.0 137.0
 OEM NO. ME031939
 EX 42.0 9.0 137.0

SIZE
 STD

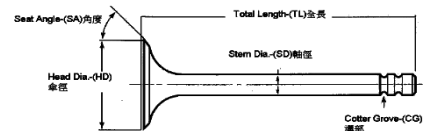

Valve Seat

OEM NO. ME031929/30
 IN 51.0 44.2 6.8
 OEM NO. ME031933/34
 EX 44.0 38.0 6.8

SIZE
 STD

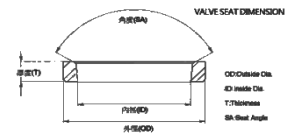

Valve Guide

OEM NO. ME031293
 IN 64.0 9.0 15.0
 OEM NO. ME031888
 EX 71.0 9.0 15.0

SIZE
 STD

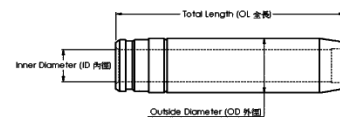

Gasket Set

OEM NO.



MITSUBISHI 6D16-3AT

Application : TRUCK
Number of Cylinders 6
Cylinder dia. 118.0 MM
Swept Volume 7545 ccm

Piston kit-Set

OEM NO. ME072570



Piston

SIZE

Comp : 71.1 w/al-fin Height : -22.3 oil-cooled Length : 116.3
Top Shape : Ø57.0
Direct Injection
Pin : 38.0 Length : 93.0

STD

Piston Ring

OEM NO. ME997467
NPR : SDM31-054ZZ



OEM Ring Groove

SIZE

Top : 2.806DK
2nd : 2.5
Oil : 4.0

STD

Cylinder Liner

OEM NO. ME041105



Liner&Sleeve

SIZE

In Diameter : 118.0
Out Diameter : 122.0
Total length : 206.0
Flange : 128.0*8.0+1.5

STD

Engine Bearing

MAIN : ME999199
CON.ROD : ME032518
T/W : ME031059
C/B :
BUSH : ME072128



SIZE

STD

Engine Valve

OEM NO. ME031938
IN 47.0 9.0 137.0
OEM NO. ME031940
EX 40.0 9.0 137.0

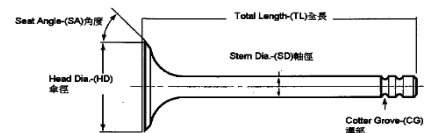

SIZE

STD

Valve Seat

OEM NO. ME031931/32
IN 49.0 40.0 6.8
OEM NO. ME031935/36
EX 42.0 36.0 6.8

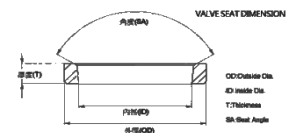

SIZE

STD

Valve Guide

OEM NO. ME031293
IN 64.0 9.0 15.0
OEM NO. ME031888
EX 71.0 9.0 15.0

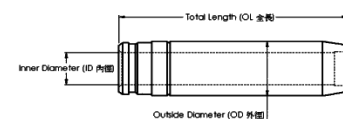

SIZE

STD

Gasket Set

OEM NO.



Piston kit-Set

OEM NO. ME072000



Piston

SIZE

Comp : 71.1 w/al-fin Height : -21.1 Length : 116.1
Top Shape : Ø59.0
Direct Injection
Pin : 38.0 Length : 92.0

STD

Piston Ring

OEM NO. ME999540
NPR : SDM31-036ZZ



OEM Ring Groove

SIZE

Top : 3.0
2nd : 2.5
Oil : 4.0

STD

Cylinder Liner

OEM NO. ME071224



Liner&Sleeve

SIZE

In Diameter : 118.0
Out Diameter : 122.0
Total length : 204.0
Flange : 128.0*8.0

STD

Engine Bearing

MAIN : ME999199
CON.ROD : ME032518
T/W : ME031059
C/B :
BUSH : ME033943



SIZE

STD

Engine Valve

OEM NO. ME031938
IN 47.0 9.0 137.0
OEM NO. ME031940
EX 40.0 9.0 137.0

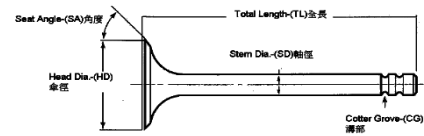

SIZE

STD

Valve Seat

OEM NO. ME031931/32
IN 49.0 40.0 6.8
OEM NO. ME031935/36
EX 42.0 36.0 6.8

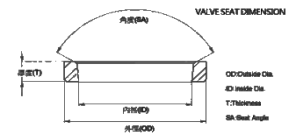

SIZE

STD

Valve Guide

OEM NO. ME031293
IN 64.0 9.0 15.0
OEM NO. ME031888
EX 71.0 9.0 15.0

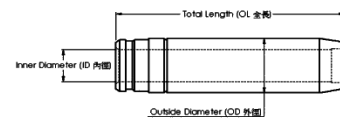

SIZE

STD

Gasket Set

OEM NO.



Piston kit-Set

OEM NO. ME072062

Piston	SIZE
Comp : 71.1 w/al-fin Height : -21.1 Length : 116.1 Top Shape : Ø59.3 Direct Injection Pin : 38.0 Length : 92.0	STD



Piston Ring

OEM NO. ME999540
NPR : SDM31-036ZZ

OEM Ring Groove	SIZE
Top : 3.0 2nd : 2.5 Oil : 4.0	STD



Cylinder Liner

OEM NO. ME071224

Liner&Sleeve	SIZE
In Diameter : 118.0 Out Diameter : 122.0 Total length : 204.0 Flange : 128.0*8.0	STD



Engine Bearing

MAIN : ME999199
CON.ROD : ME032518
T/W : ME031059
C/B :
BUSH : ME033943

SIZE
STD



Engine Valve

OEM NO. ME031938
IN 47.0 9.0 137.0
OEM NO. ME031940
EX 40.0 9.0 137.0

SIZE
STD

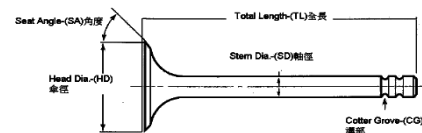

Valve Seat

OEM NO. ME031931/32
IN 49.0 40.0 6.8
OEM NO. ME031935/36
EX 42.0 36.0 6.8

SIZE
STD

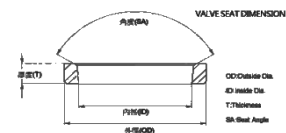

Valve Guide

OEM NO. ME031293
IN 64.0 9.0 15.0
OEM NO. ME031888
EX 71.0 9.0 15.0

SIZE
STD

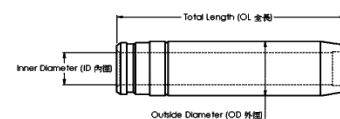

Gasket Set

OEM NO.



Piston kit-Set

OEM NO. ME072324

Piston

SIZE

Comp : 71.2 w/al-fin Height : -21.1 Length : 116.1
Top Shape : Ø59.0
Direct Injection
Pin : 38.0 Length : 93.0

STD

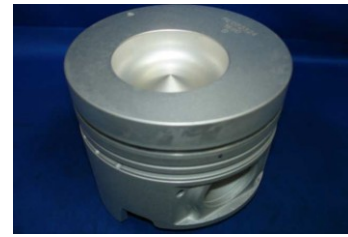

Piston Ring

OEM NO. ME999540

NPR : SDM31-036ZZ

OEM Ring Groove

SIZE

Top : 3.0
2nd : 2.5
Oil : 4.0

STD



Cylinder Liner

OEM NO. ME071224

Liner&Sleeve

SIZE

In Diameter : 118.0
Out Diameter : 122.0
Total length : 204.0
Flange : 128.0*8.0

STD



Engine Bearing

MAIN : ME999199

CON.ROD : ME032518

T/W : ME031059

C/B :

BUSH : ME033943

SIZE

STD



Engine Valve

OEM NO. ME031938

IN 47.0 9.0 137.0

OEM NO. ME031940

EX 40.0 9.0 137.0

SIZE

STD

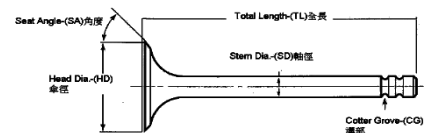

Valve Seat

OEM NO. ME031931/32

IN 49.0 40.0 6.8

OEM NO. ME031935/36

EX 42.0 36.0 6.8

SIZE

STD

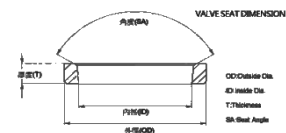

Valve Guide

OEM NO. ME031293

IN 64.0 9.0 15.0

OEM NO. ME031888

EX 71.0 9.0 15.0

SIZE

STD

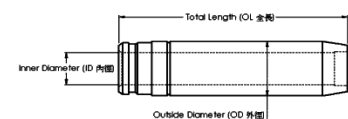

Gasket Set

OEM NO.



Piston kit-Set

OEM NO. ME072445

Piston

SIZE

Comp : 71.1 Height : Length : 116.1
Top Shape : Ø57.0
Direct Injection
Pin : 38.0 Length : 92.0

STD

Piston Ring

OEM NO. ME999540
NPR : SDM31-036ZZ

OEM Ring Groove

SIZE

Top : 3.0
2nd : 2.5
Oil : 4.0

STD



Cylinder Liner

OEM NO. ME071224

Liner&Sleeve

SIZE

In Diameter : 118.0
Out Diameter : 122.0
Total length : 204.0
Flange : 128.0*8.0

STD



Engine Bearing

MAIN : ME999199
CON.ROD : ME032518
T/W : ME031059
C/B :
BUSH : ME033943

SIZE

STD



Engine Valve

OEM NO. ME031938
IN 47.0 9.0 137.0
OEM NO. ME031940
EX 40.0 9.0 137.0

SIZE

STD

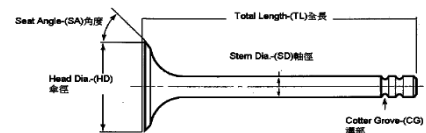

Valve Seat

OEM NO. ME031931/32
IN 49.0 40.0 6.8
OEM NO. ME031935/36
EX 42.0 36.0 6.8

SIZE

STD

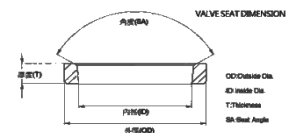

Valve Guide

OEM NO. ME031293
IN 64.0 9.0 15.0
OEM NO. ME031888
EX 71.0 9.0 15.0

SIZE

STD

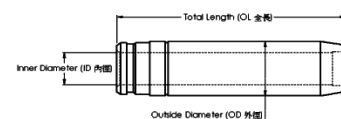

Gasket Set

OEM NO.



MITSUBISHI

6D16T

Application : TRUCK
Number of Cylinders 6
Cylinder dia. 118.0 MM
Swept Volume 7545 ccm

Piston kit-Set

OEM NO. ME072065

Piston

SIZE

Comp : 71.1 w/al-fin Height : -24.0 Length : 116.1
 Top Shape : Ø62.5
 Direct Injection
 Pin : 38.0 Length : 92.0

STD



Piston Ring

OEM NO. ME997999
 NPR : SDM31-084ZZ

OEM Ring Groove

SIZE

Top : 2.8DK
 2nd : 2.5
 Oil : 4.0

STD



Cylinder Liner

OEM NO. ME041105

Liner&Sleeve

SIZE

In Diameter : 118.0
 Out Diameter : 122.0
 Total length : 206.0
 Flange : 128.0*8.0+1.5

STD



Engine Bearing

MAIN : ME999199
 CON.ROD : ME032518
 T/W : ME031059
 C/B :
 BUSH : ME072128

SIZE

STD



Engine Valve

OEM NO. ME031938
 IN 47.0 9.0 137.0
 OEM NO. ME031940
 EX 40.0 9.0 137.0

SIZE

STD

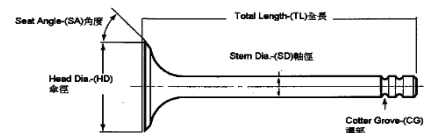

Valve Seat

OEM NO. ME031931/32
 IN 49.0 40.0 6.8
 OEM NO. ME031935/36
 EX 42.0 36.0 6.8

SIZE

STD

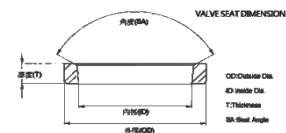

Valve Guide

OEM NO. ME031293
 IN 64.0 9.0 15.0
 OEM NO. ME031888
 EX 71.0 9.0 15.0

SIZE

STD

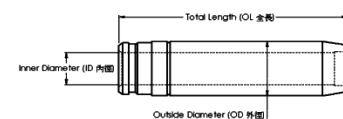

Gasket Set

OEM NO.



MITSUBISHI 6D16T

Application : TRUCK
Number of Cylinders 6
Cylinder dia. 118.0 MM
Swept Volume 7545 ccm

Piston kit-Set

OEM NO. ME078502

Piston

SIZE

Comp : 71.2 w/al-fin Height : -21.8 Length : 116.2
Top Shape : Ø58.5
Direct Injection
Pin : 38.0 Length : 93.0

STD

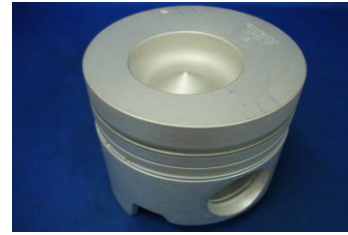

Piston Ring

OEM NO. ME997999
NPR : SDM31-084ZZ

OEM Ring Groove

SIZE

Top : 2.8DK
2nd : 2.5
Oil : 4.0

STD



Cylinder Liner

OEM NO. ME041105

Liner&Sleeve

SIZE

In Diameter : 118.0
Out Diameter : 122.0
Total length : 206.0
Flange : 128.0*8.0+1.5

STD



Engine Bearing

MAIN : ME999199
CON.ROD : ME032518
T/W : ME031059
C/B :
BUSH : ME072128

SIZE

STD



Engine Valve

OEM NO. ME031938
IN 47.0 9.0 137.0
OEM NO. ME031940
EX 40.0 9.0 137.0

SIZE

STD

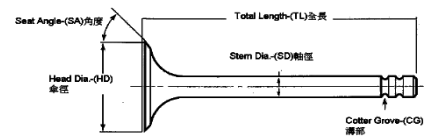

Valve Seat

OEM NO. ME031931/32
IN 49.0 40.0 6.8
OEM NO. ME031935/36
EX 42.0 36.0 6.8

SIZE

STD

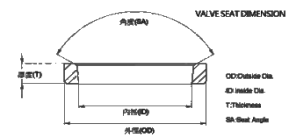

Valve Guide

OEM NO. ME031293
IN 64.0 9.0 15.0
OEM NO. ME031888
EX 71.0 9.0 15.0

SIZE

STD

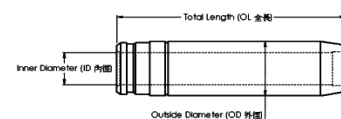

Gasket Set

OEM NO.



MITSUBISHI

6D16-3AT

Application : TRUCK
Number of Cylinders 6
Cylinder dia. 118.0 MM
Swept Volume 7545 ccm

Piston kit-Set

OEM NO. ME300199/ME078757



Piston

SIZE

Comp : 71.2 w/al-fin Height : -22.4 oil-cooled Length : 116.3
Top Shape : Ø57.0
Direct Injection
Pin : 42.0 Length : 93.0

STD

Piston Ring

OEM NO. ME997999
NPR : SDM31-084ZZ



OEM Ring Groove

SIZE

Top : 2.8DK
2nd : 2.5
Oil : 4.0

STD

Cylinder Liner

OEM NO. ME041105



Liner&Sleeve

SIZE

In Diameter : 118.0
Out Diameter : 122.0
Total length : 206.0
Flange : 128.0*8.0+1.5

STD

Engine Bearing

MAIN : ME999199
CON.ROD : ME032518
T/W : ME031059
C/B :
BUSH :



SIZE

STD

Engine Valve

OEM NO. ME031938
IN 47.0 9.0 137.0
OEM NO. ME031940
EX 40.0 9.0 137.0

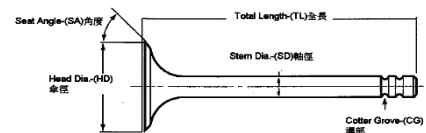

SIZE

STD

Valve Seat

OEM NO. ME031931/32
IN 49.0 40.0 6.8
OEM NO. ME031935/36
EX 42.0 36.0 6.8

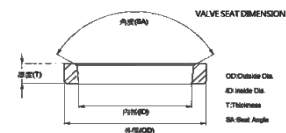

SIZE

STD

Valve Guide

OEM NO. ME031293
IN 64.0 9.0 15.0
OEM NO. ME031888
EX 71.0 9.0 15.0

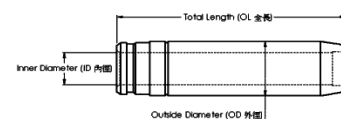

SIZE

STD

Gasket Set

OEM NO.



Piston kit-Set

OEM NO. ME072549

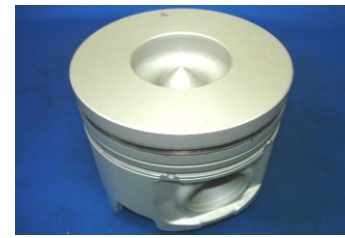

Piston

SIZE

Comp : 71.2 w/al-fin Height : -21.8 oil-cooled Length : 116.2
 Top Shape : Ø52.9
 Direct Injection
 Pin : 38.0 Length : 93.0

STD

Piston Ring

OEM NO. ME997999
 NPR : SDM31-084ZZ



OEM Ring Groove

SIZE

Top : 2.8DK
 2nd : 2.5
 Oil : 4.0

STD

Cylinder Liner

OEM NO. ME041105



Liner&Sleeve

SIZE

In Diameter : 118.0
 Out Diameter : 122.0
 Total length : 206.0
 Flange : 128.0*8.0+1.5

STD

Engine Bearing

MAIN : ME999199
 CON.ROD : ME032518
 T/W : ME031059
 C/B :
 BUSH : ME072128



SIZE

STD

Engine Valve

OEM NO. ME031938
 IN 47.0 9.0 137.0
 OEM NO. ME031940
 EX 40.0 9.0 137.0

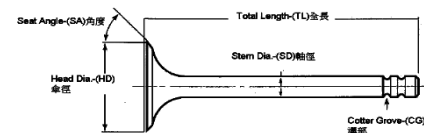

SIZE

STD

Valve Seat

OEM NO. ME031931/32
 IN 49.0 40.0 6.8
 OEM NO. ME031935/36
 EX 42.0 36.0 6.8

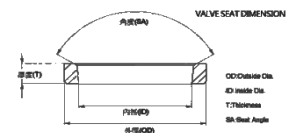

SIZE

STD

Valve Guide

OEM NO. ME031293
 IN 64.0 9.0 15.0
 OEM NO. ME031888
 EX 71.0 9.0 15.0

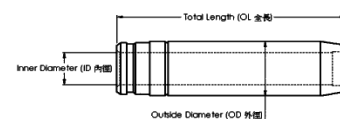

SIZE

STD

Gasket Set

OEM NO.



Piston kit-Set

OEM NO. ME072394



Piston

SIZE

Comp : 66.3 w/al-fin Height : -21.7 Length : 111.1
Top Shape : Ø58.9
Direct Injection
Pin : 38.0 Length : 93.0

STD

Piston Ring

OEM NO. ME999540
NPR : SDM31-036ZZ



OEM Ring Groove

SIZE

Top : 3.0
2nd : 2.5
Oil : 4.0

STD

Cylinder Liner

OEM NO.



Liner&Sleeve

SIZE

In Diameter : 118.0
Out Diameter : 122.0
Total length : 209.0
Flange : 128.0*8.0

STD

Engine Bearing

MAIN : ME999199
CON.ROD : ME032518
T/W : ME031059
C/B :
BUSH : ME072128



SIZE

STD

Engine Valve

OEM NO. ME170313
IN 51.0 9.0 137.0
OEM NO. ME170315
EX 44.0 9.0 137.0

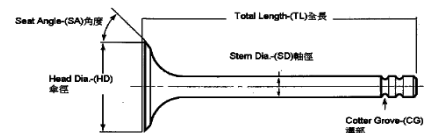

SIZE

STD

Valve Seat

OEM NO.
IN
OEM NO.
EX

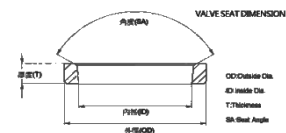

SIZE

STD

Valve Guide

OEM NO. ME031293
IN/EX 64.0 9.0 15.0

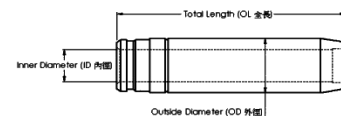

SIZE

STD

Gasket Set

OEM NO.



Piston kit-Set

OEM NO. ME072548



Piston

SIZE

Comp : 61.2 w/al-fin Height : -24 Length : 111.2
Top Shape : Ø53
Direct Injection
Pin : 38.0 Length : 93.0

STD

Piston Ring

OEM NO. ME999540
NPR : SDM31-036ZZ



OEM Ring Groove

SIZE

Top : 3.0
2nd : 2.5
Oil : 4.0

STD

Cylinder Liner

OEM NO.



Liner&Sleeve

SIZE

In Diameter : 118.0
Out Diameter : 122.0
Total length : 209.0
Flange : 128.0*8.0

STD

Engine Bearing

MAIN : ME999199
CON.ROD : ME032518
T/W : ME031059
C/B :
BUSH : ME072128



SIZE

STD

Engine Valve

OEM NO. ME170313
IN 51.0 9.0 137.0
OEM NO. ME170315
EX 44.0 9.0 137.0

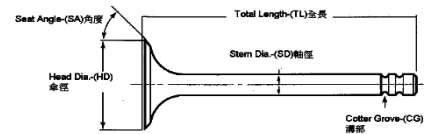

SIZE

STD

Valve Seat

OEM NO.
IN
OEM NO.
EX

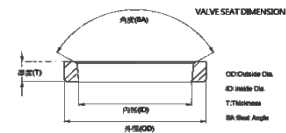

SIZE

STD

Valve Guide

OEM NO. ME031293
IN/EX 64.0 9.0 15.0

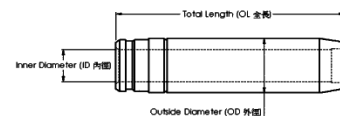

SIZE

STD

Gasket Set

OEM NO.



Piston kit-Set

OEM NO. ME052264/30917-10101

Piston	SIZE
Comp : 82.0 w/al-fin Height : -22.7 Length : 158.3 Top Shape : Ø75.0 Direct Injection Pin : 50.0 Length : 101.0	STD

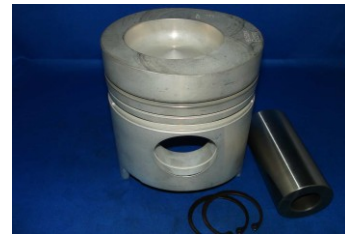

Piston Ring

OEM NO. ME052145
NPR : SDM31-023ZY

OEM Ring Groove	SIZE
Top : 3.3DK 2nd : 3.0 Oil : 6.0	STD



Cylinder Liner

OEM NO. ME051157

Liner&Sleeve	SIZE
In Diameter : 125.0 Out Diameter : 143.0 Total length : 261.3 Flange : 153.0*11.5+1.3	STD



Engine Bearing

MAIN : ME052053
CON.ROD : ME052069
T/W : 31109-07109
C/B :
BUSH : ME052159

SIZE
STD



Engine Valve

OEM NO. ME051696
IN 55.0 12.0 174.7
OEM NO. ME051697
EX 50.0 12.0 174.7

SIZE
STD

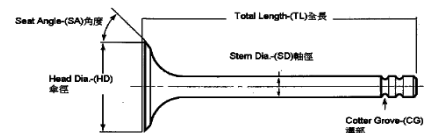

Valve Seat

OEM NO. 30901-00492
IN 57.0 49.0 7.3
OEM NO. 31201-70591
EX 52.0 43.0 7.3

SIZE
STD

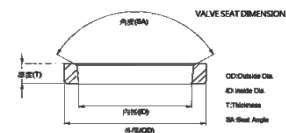

Valve Guide

OEM NO. ME051120
IN 83.0 12.0 20.0
OEM NO. ME051122
EX 93.5 12.0 20.0

SIZE
STD

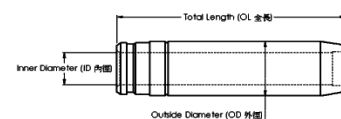

Gasket Set

OEM NO.



Piston kit-Set

OEM NO. ME052983

Piston

SIZE

Comp : 83.1 w/al-fin Height : -23.5 Length : 158.2
Top Shape : Ø80.0
Direct Injection
Pin : 50.0 Length : 106.0

STD



Piston Ring

OEM NO. ME052889

NPR : SJM31-111ZZ

OEM Ring Groove

SIZE

Top : 3.3DK
2nd : 3.0
Oil : 4.0

STD



Cylinder Liner

OEM NO. ME051500

Liner&Sleeve

SIZE

In Diameter : 130.0
Out Diameter : 147.0
Total length : 261.8
Flange : 156.0*11.5+1.8

STD



Engine Bearing

MAIN : ME052053

CON.ROD : ME052069

T/W : 31109-07109

C/B :

BUSH : ME052159

SIZE

STD



Engine Valve

OEM NO. ME051696

IN 55.0 12.0 174.7

OEM NO. ME051697

EX 50.0 12.0 174.7

SIZE

STD

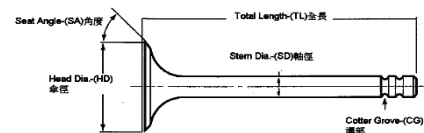

Valve Seat

OEM NO. 30901-00492

IN 57.0 49.0 7.3

OEM NO. 31201-70591

EX 52.0 43.0 7.3

SIZE

STD

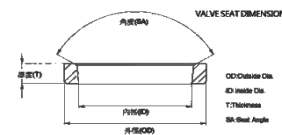

Valve Guide

OEM NO. ME051120

IN 83.0 12.0 20.0

OEM NO. ME051122

EX 93.5 12.0 20.0

SIZE

STD

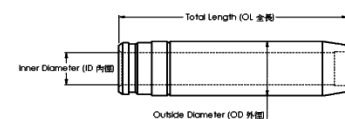

Gasket Set

OEM NO.



MITSUBISHI 6D22-3AT

Application : TRUCK
Number of Cylinders 6
Cylinder dia. 130.0 MM
Swept Volume 11149 ccm

Piston kit-Set

OEM NO. ME052792

Piston

SIZE

Comp : 83.2 w/al-fin Height : -24.6 oil-cooled Length : 158.2
Top Shape : Ø80.0
Direct Injection
Pin : 50.0 Length : 105.0

STD



Piston Ring

OEM NO. ME052889

NPR : SJM31-111ZZ

OEM Ring Groove

SIZE

Top : 3.3DK
2nd : 3.0
Oil : 4.0

STD



Cylinder Liner

OEM NO. ME051500

Liner&Sleeve

SIZE

In Diameter : 130.0
Out Diameter : 147.0
Total length : 261.8
Flange : 156.0*11.5+1.8

STD



Engine Bearing

MAIN : ME052053

CON.ROD : ME052069

T/W : 31109-07109

C/B :

BUSH : ME052159

SIZE

STD



Engine Valve

OEM NO. ME051696

IN 55.0 12.0 174.7

OEM NO. ME051697

EX 50.0 12.0 174.7

SIZE

STD

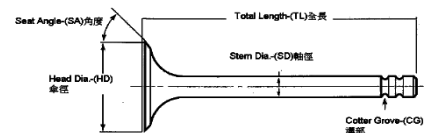

Valve Seat

OEM NO. 30901-00492

IN 57.0 49.0 7.3

OEM NO. 31201-70591

EX 52.0 43.0 7.3

SIZE

STD

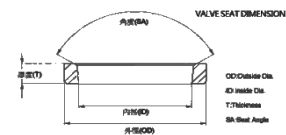

Valve Guide

OEM NO. ME051120

IN 83.0 12.0 20.0

OEM NO. ME051122

EX 93.5 12.0 20.0

SIZE

STD

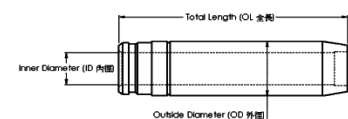

Gasket Set

OEM NO.



Piston kit-Set

OEM NO. ME052276

Piston

SIZE

Comp : 83.0 w/al-fin Height : -24.7 Length : 158.0
 Top Shape : Ø80.0
 Direct Injection
 Pin : 50.0 Length : 105.0

STD

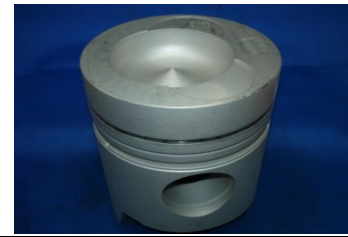

Piston Ring

OEM NO. ME052124
 NPR : SDM31-015ZY

OEM Ring Groove

SIZE

Top : 3.3DK
 2nd : 3.0
 Oil : 6.0

STD



Cylinder Liner

OEM NO. ME051500

Liner&Sleeve

SIZE

In Diameter : 130.0
 Out Diameter : 147.0
 Total length : 261.8
 Flange : 156.0*11.5+1.8

STD



Engine Bearing

MAIN : ME052053
 CON.ROD : ME052069
 T/W : 31109-07109
 C/B :
 BUSH : ME052159

SIZE

STD



Engine Valve

OEM NO. ME051696
 IN 55.0 12.0 174.7
 OEM NO. ME051697
 EX 50.0 12.0 174.7

SIZE

STD

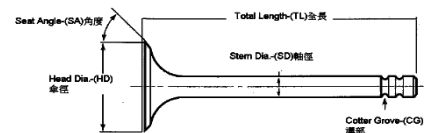

Valve Seat

OEM NO. 30901-00492
 IN 57.0 49.0 7.3
 OEM NO. 31201-70591
 EX 52.0 43.0 7.3

SIZE

STD

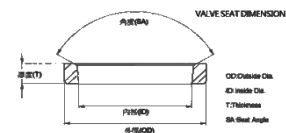

Valve Guide

OEM NO. 31101-00602
 IN 83.0 12.0 20.0
 OEM NO. 31201-30700
 EX 93.5 12.0 20.0

SIZE

STD

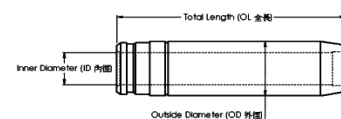

Gasket Set

OEM NO.



Piston kit-Set

OEM NO. ME052447

Piston

SIZE

Comp : 83.1 w/al-fin Height : -26.3 Length : 158.0
 Top Shape : Ø70.1
 Direct Injection
 Pin : 50.0 Length : 105.0

STD



Piston Ring

OEM NO. ME052124
 NPR : SDM31-015ZY

OEM Ring Groove

SIZE

Top : 3.3DK
 2nd : 3.0
 Oil : 6.0

STD



Cylinder Liner

OEM NO. ME051500

Liner&Sleeve

SIZE

In Diameter : 130.0
 Out Diameter : 147.0
 Total length : 261.8
 Flange : 156.0*11.5+1.8

STD



Engine Bearing

MAIN : ME052053
 CON.ROD : ME052069
 T/W : 31109-07109
 C/B :
 BUSH : ME052159

SIZE

STD



Engine Valve

OEM NO. ME051696
 IN 55.0 12.0 174.7
 OEM NO. ME051697
 EX 50.0 12.0 174.7

SIZE

STD

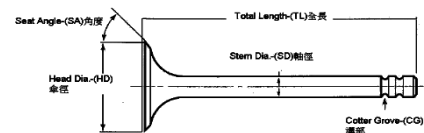

Valve Seat

OEM NO. 30901-00492
 IN 57.0 49.0 7.3
 OEM NO. 31201-70591
 EX 52.0 43.0 7.3

SIZE

STD

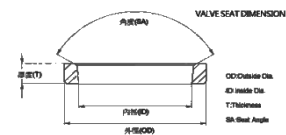

Valve Guide

OEM NO. 31101-00602
 IN 83.0 12.0 20.0
 OEM NO. 31201-30700
 EX 93.5 12.0 20.0

SIZE

STD

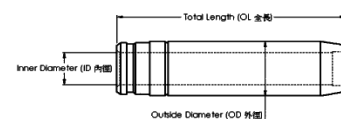

Gasket Set

OEM NO.



Piston kit-Set

OEM NO. ME052902

Piston

SIZE

Comp : 82.9 w/al-fin Height : -27.7 Length : 157.8
Top Shape : Ø70.2
Direct Injection
Pin : 50.0 Length : 105.0

STD

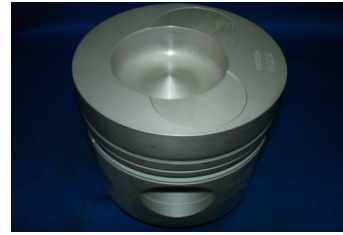

Piston Ring

OEM NO. ME052124
NPR : SDM31-015ZY

OEM Ring Groove

SIZE

Top : 3.3DK
2nd : 3.0
Oil : 6.0

STD



Cylinder Liner

OEM NO. ME051500

Liner&Sleeve

SIZE

In Diameter : 130.0
Out Diameter : 147.0
Total length : 261.8
Flange : 156.0*11.5+1.8

STD



Engine Bearing

MAIN : ME052053
CON.ROD : ME052069
T/W : 31109-07109
C/B :
BUSH : ME052159

SIZE

STD



Engine Valve

OEM NO. ME051696
IN 55.0 12.0 174.7
OEM NO. ME051697
EX 50.0 12.0 174.7

SIZE

STD

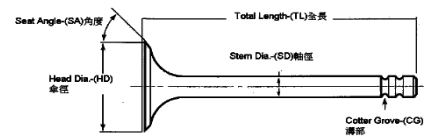

Valve Seat

OEM NO. 30901-00492
IN 57.0 49.0 7.3
OEM NO. 31201-70591
EX 52.0 43.0 7.3

SIZE

STD

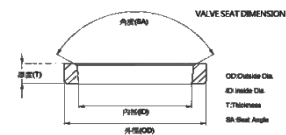

Valve Guide

OEM NO. 31101-00601
IN 83.0 12.0 20.0
OEM NO. 31201-30700
EX 93.5 12.0 20.0

SIZE

STD

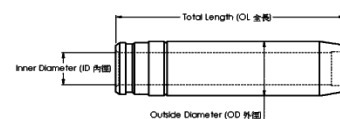

Gasket Set

OEM NO.



MITSUBISHI 6D22T-3V

Application : TRUCK
Number of Cylinders 6
Cylinder dia. 130.0 MM
Swept Volume 11149 ccm

Piston kit-Set

OEM NO. ME150132



Piston

SIZE

Comp : 83.1 w/al-fin Height : -24.8 Length : 158.0
Top Shape : Ø80.0
Direct Injection
Pin : 50.0 Length : 106.0

STD

Piston Ring

OEM NO. ME052889

NPR : SJM31-011ZZ

OEM Ring Groove

SIZE

Top : 3.3DK
2nd : 3.0
Oil : 4.0

STD



Cylinder Liner

OEM NO. ME051500

Liner&Sleeve

SIZE

In Diameter : 130.0
Out Diameter : 147.0
Total length : 261.8
Flange : 156.0*11.5+1.8

STD



Engine Bearing

MAIN : ME052053

CON.ROD : ME052069

T/W : 31109-07109

C/B :

BUSH : ME052159

SIZE

STD



Engine Valve

OEM NO. ME051696

IN 55.0 12.0 174.7

OEM NO. ME051697

EX 50.0 12.0 174.7

SIZE

STD

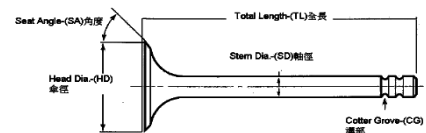

Valve Seat

OEM NO. 30901-00492

IN 57.0 49.0 7.3

OEM NO. 31201-70591

EX 52.0 43.0 7.3

SIZE

STD

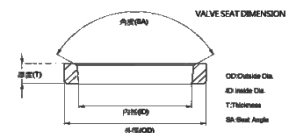

Valve Guide

OEM NO. 31101-00601

IN 83.0 12.0 20.0

OEM NO. 31201-30700

EX 93.5 12.0 20.0

SIZE

STD

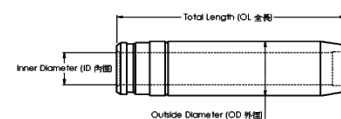

Gasket Set

OEM NO.



Piston kit-Set

OEM NO. 23411-83410

Piston

SIZE

Comp : 83.3 w/al-fin Height : oil-cooled Length : 158.0
Top Shape : Ø67.0
Direct Injection
Pin : 50.0 Length : 105.0

STD

Piston Ring

OEM NO. ME052889
NPR : SJM31-111ZZ

OEM Ring Groove

SIZE

Top : 3.3DK
2nd : 3.0
Oil : 4.0

STD



Cylinder Liner

OEM NO. ME051500

Liner&Sleeve

SIZE

In Diameter : 130.0
Out Diameter : 147.0
Total length : 261.8
Flange : 156.0*11.5+1.8

STD



Engine Bearing

MAIN : ME052053
CON.ROD : ME052069
T/W : 31109-07109
C/B :
BUSH : ME052159

SIZE

STD



Engine Valve

OEM NO. ME051696
IN 55.0 12.0 174.7
OEM NO. ME051697
EX 50.0 12.0 174.7

SIZE

STD

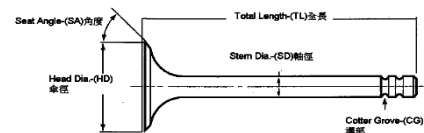

Valve Seat

OEM NO. 30901-00492
IN 57.0 49.0 7.3
OEM NO. 31201-70591
EX 52.0 43.0 7.3

SIZE

STD

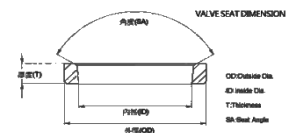

Valve Guide

OEM NO. 31101-00601
IN 83.0 12.0 20.0
OEM NO. 31201-30700
EX 93.5 12.0 20.0

SIZE

STD

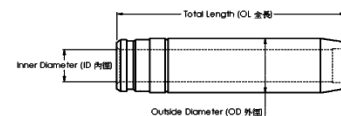

Gasket Set

OEM NO.



Piston kit-Set

OEM NO. ME052540

Piston

SIZE

Comp : 83.3 w/al-fin Height : -22.4 Length : 158.0
Top Shape : Ø82.6
Direct Injection
Pin : 50.0 Length : 105.0

STD



Piston Ring

OEM NO. ME052124
NPR : SDM31-015ZY

OEM Ring Groove

SIZE

Top : 3.3DK
2nd : 3.0
Oil : 6.0

STD



Cylinder Liner

OEM NO. ME051500

Liner&Sleeve

SIZE

In Diameter : 130.0
Out Diameter : 147.0
Total length : 261.8
Flange : 156.0*11.5+1.8

STD



Engine Bearing

MAIN : ME052053
CON.ROD : ME052069
T/W : 31109-07109
C/B :
BUSH : ME052159

SIZE

STD



Engine Valve

OEM NO. ME051696
IN 55.0 12.0 174.7
OEM NO. ME051697
EX 50.0 12.0 174.7

SIZE

STD

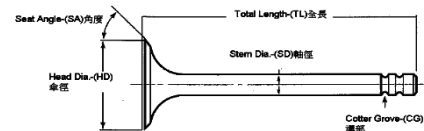

Valve Seat

OEM NO. 30901-00492
IN 57.0 49.0 7.3
OEM NO. 31201-70591
EX 52.0 43.0 7.3

SIZE

STD

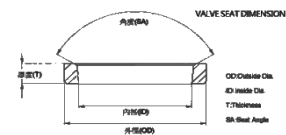

Valve Guide

OEM NO. 31101-00601
IN 83.0 12.0 20.0
OEM NO. 31201-30700
EX 93.5 12.0 20.0

SIZE

STD

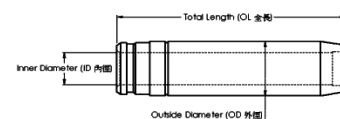

Gasket Set

OEM NO.



Piston kit-Set

OEM NO. ME052664

Piston

SIZE

Comp : 83.1 w/al-fin Height : -21.35 Length : 158.0
Top Shape : Ø82.5
Direct Injection
Pin : 50.0 Length : 105.0

STD

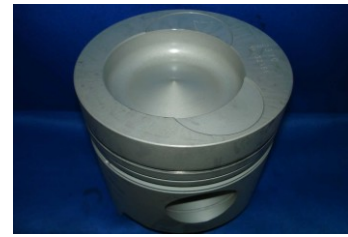

Piston Ring

OEM NO. ME052124
NPR : SDM31-015ZY

OEM Ring Groove

SIZE

Top : 3.3DK
2nd : 3.0
Oil : 6.0

STD



Cylinder Liner

OEM NO. ME051500

Liner&Sleeve

SIZE

In Diameter : 130.0
Out Diameter : 147.0
Total length : 261.8
Flange : 156.0*11.5+1.8

STD



Engine Bearing

MAIN : ME052053
CON.ROD : ME052069
T/W : 31109-07109
C/B :
BUSH : ME052159

SIZE

STD



Engine Valve

OEM NO. ME051696
IN 55.0 12.0 174.7
OEM NO. ME051697
EX 50.0 12.0 174.7

SIZE

STD

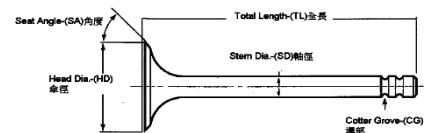

Valve Seat

OEM NO. 30901-00492
IN 57.0 49.0 7.3
OEM NO. 31201-70591
EX 52.0 43.0 7.3

SIZE

STD

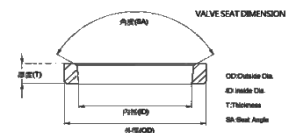

Valve Guide

OEM NO. 31101-00601
IN 83.0 12.0 20.0
OEM NO. 31201-30700
EX 93.5 12.0 20.0

SIZE

STD

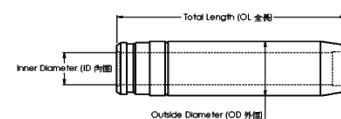

Gasket Set

OEM NO.



Piston kit-Set

OEM NO. ME052818/ME052115

Piston	SIZE
Comp : 83.1 w/al-fin Height : Length : 158.0 Top Shape : Ø Direct Injection Pin : 50.0 Length : 105.0	STD

Piston Ring

OEM NO. ME052124
NPR : SDM31-015ZY

OEM Ring Groove	SIZE
Top : 3.3DK 2nd : 3.0 Oil : 6.0	STD



Cylinder Liner

OEM NO. ME051500

Liner&Sleeve	SIZE
In Diameter : 130.0 Out Diameter : 147.0 Total length : 261.8 Flange : 156.0*11.5+1.8	STD



Engine Bearing

MAIN : ME052053
CON.ROD : ME052069
T/W : 31109-07109
C/B :
BUSH : ME052159

SIZE
STD



Engine Valve

OEM NO. ME051696
IN 55.0 12.0 174.7
OEM NO. ME051697
EX 50.0 12.0 174.7

SIZE
STD

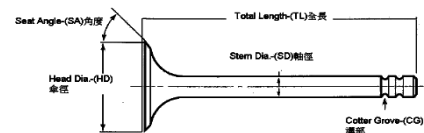

Valve Seat

OEM NO. 30901-00492
IN 57.0 49.0 7.3
OEM NO. 31201-70591
EX 52.0 43.0 7.3

SIZE
STD

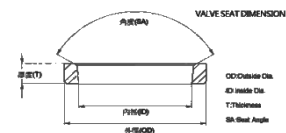

Valve Guide

OEM NO. 31101-00601
IN 83.0 12.0 20.0
OEM NO. 31201-30700
EX 93.5 12.0 20.0

SIZE
STD

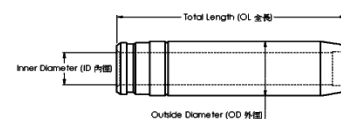

Gasket Set

OEM NO.



Piston kit-Set

OEM NO. 23411-83410

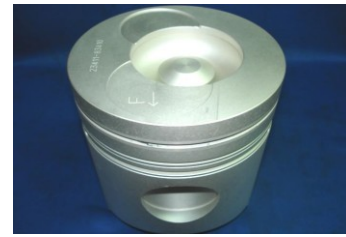

Piston

SIZE

Comp : 83.3 w/al-fin Height : -25.3 oil-cooled Length : 156.1
Top Shape : Ø67.0
Direct Injection
Pin : 50.0 Length : 106.0

STD

Piston Ring

OEM NO. ME052889
NPR : SJM31-111ZZ



OEM Ring Groove

SIZE

Top : 3.3DK
2nd : 3.0
Oil : 4.0

STD

Cylinder Liner

OEM NO. ME051500



Liner&Sleeve

SIZE

In Diameter : 130.0
Out Diameter : 147.0
Total length : 261.8
Flange : 156.0*11.5+1.8

STD

Engine Bearing

MAIN : ME052053
CON.ROD : ME052069
T/W : 31109-07109
C/B :
BUSH : ME052159



SIZE

STD

Engine Valve

OEM NO. ME051696
IN 55.0 12.0 174.7
OEM NO. ME051697
EX 50.0 12.0 174.7

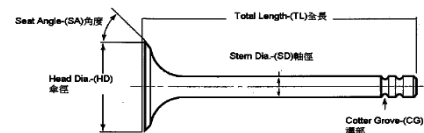

SIZE

STD

Valve Seat

OEM NO. 30901-00492
IN 57.0 49.0 7.3
OEM NO. 31201-70591
EX 52.0 43.0 7.3

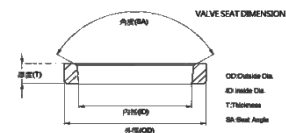

SIZE

STD

Valve Guide

OEM NO. ME051120
IN 83.0 12.0 20.0
OEM NO. ME051122
EX 93.5 12.0 20.0

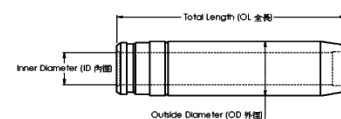

SIZE

STD

Gasket Set

OEM NO.



Piston kit-Set

OEM NO. ME058390

Piston

SIZE

Comp : 82.9 w/al-fin Height : Length : 158.0
 Top Shape : Ø85.0
 Direct Injection
 Pin : 50.0 Length : 105.0

STD



Piston Ring

OEM NO. ME052124
 NPR : SDM31-051ZY

OEM Ring Groove

SIZE

Top : 3.3DK
 2nd : 3.0
 Oil : 6.0

STD



Cylinder Liner

OEM NO. ME051500

Liner&Sleeve

SIZE

In Diameter : 130.0
 Out Diameter : 147.0
 Total length : 261.8
 Flange : 156.0*11.5+1.8

STD



Engine Bearing

MAIN : ME052053
 CON.ROD : ME052069
 T/W : 31109-07109
 C/B :
 BUSH : ME052159

SIZE

STD



Engine Valve

OEM NO. ME051696
 IN 55.0 12.0 174.7
 OEM NO. ME051697
 EX 50.0 12.0 174.7

SIZE

STD

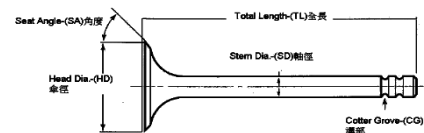

Valve Seat

OEM NO. 30901-00492
 IN 57.0 49.0 7.3
 OEM NO. 31201-70591
 EX 52.0 43.0 7.3

SIZE

STD

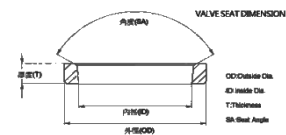

Valve Guide

OEM NO. ME051120
 IN 83.0 12.0 20.0
 OEM NO. ME051122
 EX 93.5 12.0 20.0

SIZE

STD

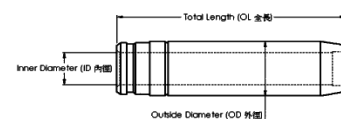

Gasket Set

OEM NO.



Piston kit-Set

OEM NO. ME052939

Piston

SIZE

Comp : 83.3 w/al-fin Height : -22.4 Length : 158.0
 Top Shape : Ø69.0
 Direct Injection
 Pin : 50.0 Length : 105.0

STD



Piston Ring

OEM NO. ME052889

NPR : SJM31-111ZZ

OEM Ring Groove

SIZE

Top : 3.3DK
 2nd : 3.0
 Oil : 4.0

STD



Cylinder Liner

OEM NO. ME051500

Liner&Sleeve

SIZE

In Diameter : 130.0
 Out Diameter : 147.0
 Total length : 261.8
 Flange : 156.0*11.5+1.8

STD



Engine Bearing

MAIN : ME052053

CON.ROD : ME052069

T/W : 31109-07109

C/B :

BUSH : ME052159

SIZE

STD



Engine Valve

OEM NO. ME051696

IN 55.0 12.0 174.7

OEM NO. ME051697

EX 50.0 12.0 174.7

SIZE

STD

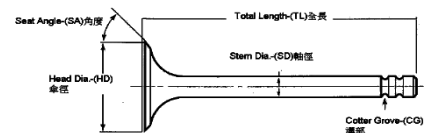

Valve Seat

OEM NO. 30901-00492

IN 57.0 49.0 7.3

OEM NO. 31201-70591

EX 52.0 43.0 7.3

SIZE

STD

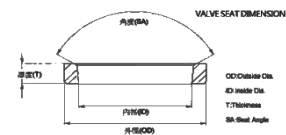

Valve Guide

OEM NO. ME051120

IN 83.0 12.0 20.0

OEM NO. ME051122

EX 93.5 12.0 20.0

SIZE

STD

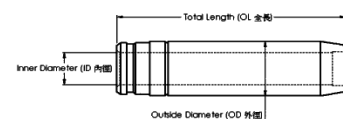

Gasket Set

OEM NO.



MITSUBISHI

6D24(2V)

Application : TRUCK
Number of Cylinders 6
Cylinder dia. 130.0 MM
Swept Volume 11945 ccm

Piston kit-Set

OEM NO. ME151395

Piston

SIZE

Comp : 78.4 w/al-fin Height : -26.3 Length : 153.2
Top Shape : Ø69.3
Direct Injection
Pin : 50.0 Length : 105.0

STD



Piston Ring

OEM NO. ME151190

NPR : SJM31-094ZZ

OEM Ring Groove

SIZE

Top : 3.3DK
2nd : 3.0
Oil : 4.0

STD



Cylinder Liner

OEM NO. ME051500

Liner&Sleeve

SIZE

In Diameter : 130.0
Out Diameter : 147.0
Total length : 261.8
Flange : 156.0*11.5+1.8

STD



Engine Bearing

MAIN : ME350864
CON.ROD : ME181338
T/W : 31209-78101
C/B :
BUSH :

SIZE

STD



Engine Valve

OEM NO. ME051696
IN 55.0 12.0 174.7
OEM NO. ME051697
EX 50.0 12.0 174.7

SIZE

STD

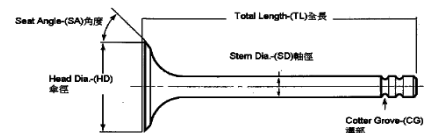

Valve Seat

OEM NO. 30901-00492
IN 57.0 49.0 7.3
OEM NO. 31201-70591
EX 52.0 43.0 7.3

SIZE

STD

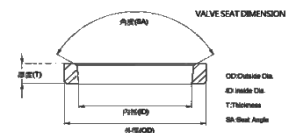

Valve Guide

OEM NO. ME051120
IN 83.0 12.0 20.0
OEM NO. ME051122
EX 93.5 12.0 20.0

SIZE

STD

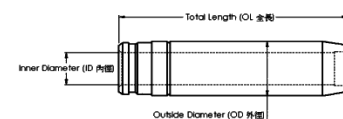

Gasket Set

OEM NO.



MITSUBISHI 6D24(2V)

Application : TRUCK
Number of Cylinders 6
Cylinder dia. 130.0 MM
Swept Volume 11945 ccm

Piston kit-Set

OEM NO. ME152652



Piston

SIZE

Comp : 78.2 w/al-fin Height : -27.0 oil-cooled Length : 153.2
Top Shape : Ø66.0
Direct Injection Head Anodized
Pin : 50.0 Length : 105.0

STD

Piston Ring

OEM NO. ME151190
NPR : SJM31-094ZZ



OEM Ring Groove

SIZE

Top : 3.3DK
2nd : 3.0
Oil : 4.0

STD

Cylinder Liner

OEM NO. ME051500



Liner&Sleeve

SIZE

In Diameter : 130.0
Out Diameter : 147.0
Total length : 261.8
Flange : 156.0*11.5+1.8

STD

Engine Bearing

MAIN : ME350864
CON.ROD : ME181338
T/W : 31209-78101
C/B :
BUSH :



SIZE

STD

Engine Valve

OEM NO. ME051696
IN 55.0 12.0 174.7
OEM NO. ME051697
EX 50.0 12.0 174.7

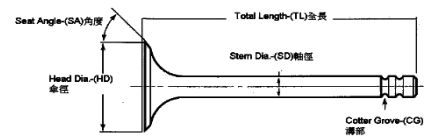

SIZE

STD

Valve Seat

OEM NO. 30901-00492
IN 57.0 49.0 7.3
OEM NO. 31201-70591
EX 52.0 43.0 7.3

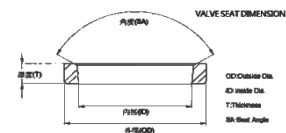

SIZE

STD

Valve Guide

OEM NO. ME051120
IN 83.0 12.0 20.0
OEM NO. ME051122
EX 93.5 12.0 20.0

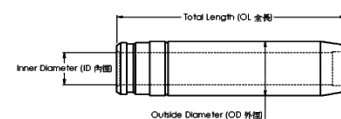

SIZE

STD

Gasket Set

OEM NO.



Piston kit-Set

OEM NO. ME150642

Piston

SIZE

Comp : 78.1 w/al-fin Height : -24.4 Length : 153.2
Top Shape : Ø68.0
Direct Injection
Pin : 50.0 Length : 106.0

STD

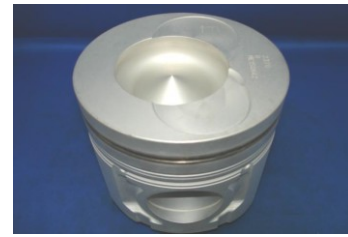

Piston Ring

OEM NO. ME995473

NPR : SJM31-057ZZ

OEM Ring Groove

SIZE

Top : 3.3
2nd : 3.0
Oil : 4.0

STD



Cylinder Liner

OEM NO. ME051500

Liner&Sleeve

SIZE

In Diameter : 130.0
Out Diameter : 147.0
Total length : 261.8
Flange : 156.0*11.5+1.8

STD



Engine Bearing

MAIN : ME350864
CON.ROD : ME181338
T/W : 31209-78101
C/B :
BUSH :

SIZE

STD



Engine Valve

OEM NO. ME051696
IN 55.0 12.0 174.7
OEM NO. ME051697
EX 50.0 12.0 174.7

SIZE

STD

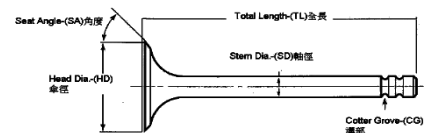

Valve Seat

OEM NO. 30901-00492
IN 57.0 49.0 7.3
OEM NO. 31201-70591
EX 52.0 43.0 7.3

SIZE

STD

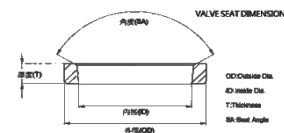

Valve Guide

OEM NO. 31101-00601
IN 83.0 12.0 20.0
OEM NO. 31201-30700
EX 93.5 12.0 20.0

SIZE

STD

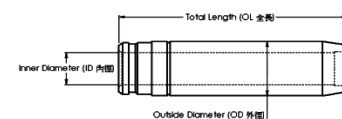

Gasket Set

OEM NO.



MITSUBISHI 6D24T(2V)

Application : TRUCK
Number of Cylinders 6
Cylinder dia. 130.0 MM
Swept Volume 11945 ccm

Piston kit-Set

OEM NO. ME151409

Piston

SIZE

Comp : 78.3 w/al-fin Height : -26.0 oil-cooled Length : 153.2
Top Shape : Ø69.4
Direct Injection
Pin : 50.0 Length : 105.0

STD



Piston Ring

OEM NO. ME151190

NPR : SJM31-094ZZ

OEM Ring Groove

SIZE

Top : 3.3DK
2nd : 3.0
Oil : 4.0

STD



Cylinder Liner

OEM NO. ME051500

Liner&Sleeve

SIZE

In Diameter : 130.0
Out Diameter : 147.0
Total length : 261.8
Flange : 156.0*11.5+1.8

STD



Engine Bearing

MAIN : ME350864

CON.ROD : ME181338

T/W : 31209-78101

C/B :

BUSH :

SIZE

STD



Engine Valve

OEM NO. ME051696

IN 55.0 12.0 174.7

OEM NO. ME051697

EX 50.0 12.0 174.7

SIZE

STD

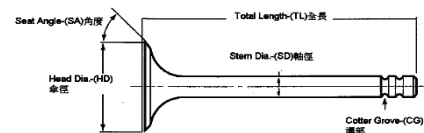

Valve Seat

OEM NO. 30901-00492

IN 57.0 49.0 7.3

OEM NO. 31201-70591

EX 52.0 43.0 7.3

SIZE

STD

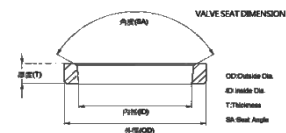

Valve Guide

OEM NO. 31101-00601

IN 83.0 12.0 20.0

OEM NO. 31201-30700

EX 93.5 12.0 20.0

SIZE

STD

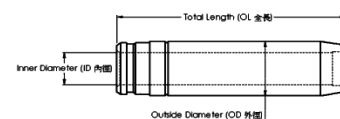

Gasket Set

OEM NO.



MITSUBISHI 6D24T(3V)

Application : TRUCK
Number of Cylinders 6
Cylinder dia. 130.0 MM
Swept Volume 11945 ccm

Piston kit-Set

OEM NO. ME151416

Piston

SIZE

Comp : 78.1 w/al-fin Height : -26.3 oil-cooled Length : 153.2
Top Shape : Ø69.3
Direct Injection
Pin : 50.0 Length : 106.0

STD

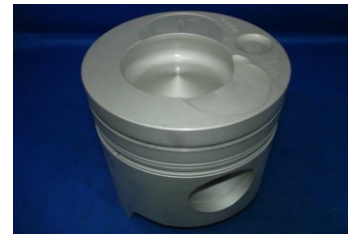

Piston Ring

OEM NO. ME151190

NPR : SJM31-094ZZ

OEM Ring Groove

SIZE

Top : 3.3DK
2nd : 3.0
Oil : 4.0

STD



Cylinder Liner

OEM NO. ME051500

Liner&Sleeve

SIZE

In Diameter : 130.0
Out Diameter : 147.0
Total length : 261.8
Flange : 156.0*11.5+1.8

STD



Engine Bearing

MAIN : ME350864
CON.ROD : ME181338
T/W : 31209-78101
C/B :
BUSH :

SIZE

STD



Engine Valve

OEM NO. ME051696
IN 55.0 12.0 174.7
OEM NO. ME051697
EX 50.0 12.0 174.7

SIZE

STD

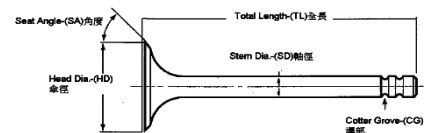

Valve Seat

OEM NO. 30901-00492
IN 57.0 49.0 7.3
OEM NO. 31201-70591
EX 52.0 43.0 7.3

SIZE

STD

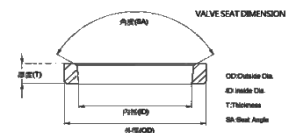

Valve Guide

OEM NO. 31101-00601
IN 83.0 12.0 20.0
OEM NO. 31201-30700
EX 93.5 12.0 20.0

SIZE

STD

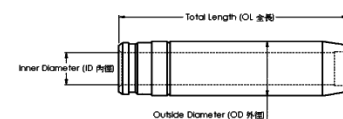

Gasket Set

OEM NO.



MITSUBISHI 6D24T(2V)

Application : TRUCK
Number of Cylinders 6
Cylinder dia. 130.0 MM
Swept Volume 11945 ccm

Piston kit-Set

OEM NO. ME153081

Piston	SIZE
Comp : 78.2 w/al-fin Height : -27.5 oil-cooled Length : 153.2 Top Shape : Ø66.0 Direct Injection Head Anodized Pin : 50.0 Length : 105.0	STD



Piston Ring

OEM NO. ME995636
NPR : SDM31-105ZY

OEM Ring Groove	SIZE
Top : 3.3DK 2nd : 2.5 Oil : 4.0	STD



Cylinder Liner

OEM NO. ME051500

Liner&Sleeve	SIZE
In Diameter : 130.0 Out Diameter : 147.0 Total length : 261.8 Flange : 156.0*11.5+1.8	STD



Engine Bearing

MAIN : ME350864
CON.ROD : ME181338
T/W : 31209-78101
C/B :
BUSH :

SIZE
STD



Engine Valve

OEM NO. ME051696
IN 55.0 12.0 174.7
OEM NO. ME051697
EX 50.0 12.0 174.7

SIZE
STD

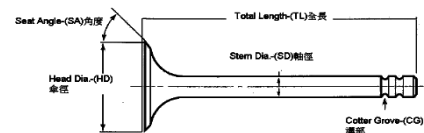

Valve Seat

OEM NO. 30901-00492
IN 57.0 49.0 7.3
OEM NO. 31201-70591
EX 52.0 43.0 7.3

SIZE
STD

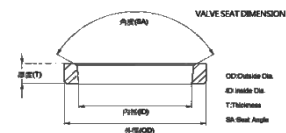

Valve Guide

OEM NO. 31101-00601
IN 83.0 12.0 20.0
OEM NO. 31201-30700
EX 93.5 12.0 20.0

SIZE
STD

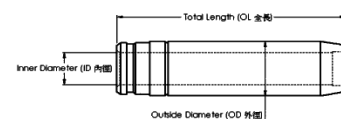

Gasket Set

OEM NO.



MITSUBISHI 6D24T(2V)

Application : TRUCK
Number of Cylinders 6
Cylinder dia. 130.0 MM
Swept Volume 11945 ccm

Piston kit-Set

OEM NO. ME158096

Piston

SIZE

Comp : 78.1 w/al-fin Height : -25.8 oil-cooled Length : 153.2
Top Shape : Ø69.5
Direct Injection
Pin : 50.0 Length : 105.0

STD



Piston Ring

OEM NO. ME151190

NPR : SJM31-094ZZ

OEM Ring Groove

SIZE

Top : 3.3DK
2nd : 3.0
Oil : 4.0

STD



Cylinder Liner

OEM NO. ME051500

Liner&Sleeve

SIZE

In Diameter : 130.0
Out Diameter : 147.0
Total length : 261.8
Flange : 156.0*11.5+1.8

STD



Engine Bearing

MAIN : ME350864

CON.ROD : ME181338

T/W : 31209-78101

C/B :

BUSH :

SIZE

STD



Engine Valve

OEM NO. ME051696

IN 55.0 12.0 174.7

OEM NO. ME051697

EX 50.0 12.0 174.7

SIZE

STD

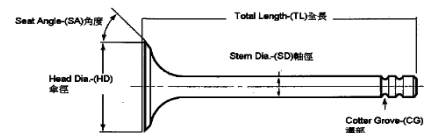

Valve Seat

OEM NO. 30901-00492

IN 57.0 49.0 7.3

OEM NO. 31201-70591

EX 52.0 43.0 7.3

SIZE

STD

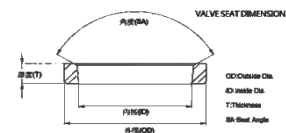

Valve Guide

OEM NO. 31101-00601

IN 83.0 12.0 20.0

OEM NO. 31201-30700

EX 93.5 12.0 20.0

SIZE

STD

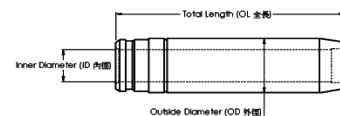

Gasket Set

OEM NO.



Piston kit-Set

OEM NO. ME120553

Piston

SIZE

Comp : 82.6 w/al-fin Height : -20.5 oil-cooled Length : 157.5
Top Shape : Ø90.0
Direct Injection
Pin : 50.0 Length : 109.0

STD



Piston Ring

OEM NO. ME121332

NPR : SJM31-091ZZ

OEM Ring Groove

SIZE

Top : 3.3DK
2nd : 3.0
Oil : 4.0

STD



Cylinder Liner

OEM NO. ME120028

Liner&Sleeve

SIZE

In Diameter : 135.0
Out Diameter : 140.0
Total length : 261.0
Flange : 149.0*9.0+1.3

STD



Engine Bearing

MAIN :
CON.ROD :
T/W :
C/B :
BUSH :

SIZE

STD



Engine Valve

OEM NO. ME120529

IN 46.0 10.0 186.2

OEM NO. ME350711

EX 46.0 10.0 185.5

SIZE

STD

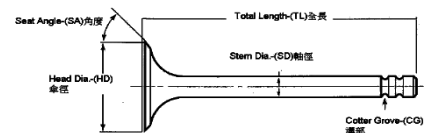

Valve Seat

OEM NO. ME160602

IN 49.0 39.9 7.1

OEM NO. ME120752

EX 49.0 39.2 7.1

SIZE

STD

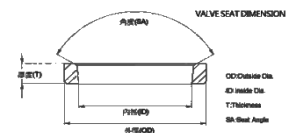

Valve Guide

OEM NO. 31101-00601

IN/EX 95.0 10.0 15.0

SIZE

STD

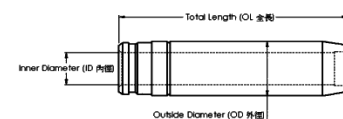

Gasket Set

OEM NO.



Piston kit-Set

OEM NO. ME120684

Piston

SIZE

Comp : 82.6 w/al-fin Height : -20.9 oil-cooled Length : 157.5
Top Shape : Ø90.0
Direct Injection
Pin : 50.0 Length : 109.0

STD



Piston Ring

OEM NO. ME121332

NPR : SJM31-091ZZ

OEM Ring Groove

SIZE

Top : 3.3DK
2nd : 3.0
Oil : 4.0

STD



Cylinder Liner

OEM NO. ME120028

Liner&Sleeve

SIZE

In Diameter : 135.0
Out Diameter : 140.0
Total length : 261.0
Flange : 149.0*9.0+1.3

STD



Engine Bearing

MAIN :
CON.ROD :
T/W :
C/B :
BUSH :

SIZE

STD



Engine Valve

OEM NO. ME120529

IN 46.0 10.0 185.2

OEM NO. ME350711

EX 46.0 10.0 185.5

SIZE

STD

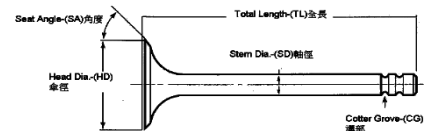

Valve Seat

OEM NO. ME160602

IN 49.0 39.9 7.1

OEM NO. ME120752

EX 49.0 39.2 7.1

SIZE

STD

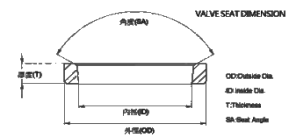

Valve Guide

OEM NO. 31101-00601

IN/EX 95.0 10.0 15.0

SIZE

STD

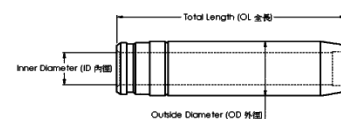

Gasket Set

OEM NO.



Piston kit-Set

OEM NO. ME121199

Piston

SIZE

Comp : 82.7 w/al-fin Height : -24.0 oil-cooled Length :
Top Shape : Ø72.0
Direct Injection
Pin : 55.0 Length : 109.0

STD



Piston Ring

OEM NO. ME120536
NPR : SDM31-056ZZ

OEM Ring Groove

SIZE

Top : 3.3DK
2nd : 3.0
Oil : 4.0

STD



Cylinder Liner

OEM NO. ME120028

Liner&Sleeve

SIZE

In Diameter : 135.0
Out Diameter : 140.0
Total length : 261.0
Flange : 149.0*9.0+1.3

STD



Engine Bearing

MAIN :
CON.ROD :
T/W :
C/B :
BUSH :

SIZE

STD



Engine Valve

OEM NO. ME120529
IN 46.0 10.0 185.2
OEM NO. ME350711
EX 46.0 10.0 185.5

SIZE

STD

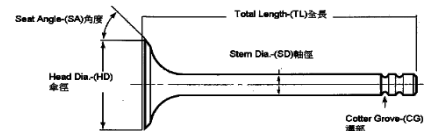

Valve Seat

OEM NO. ME160602
IN 49.0 39.9 7.1
OEM NO. ME120752
EX 49.0 39.2 7.1

SIZE

STD

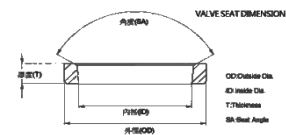

Valve Guide

OEM NO. 31101-00601
IN/EX 95.0 10.0 15.0

SIZE

STD

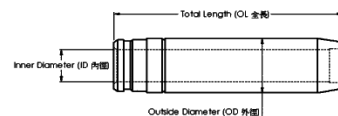

Gasket Set

OEM NO.



Piston kit-Set

OEM NO. ME121778

Piston

SIZE

Comp : 82.8 w/al-fin Height : -24.0 oil-cooled Length : 157.8
Top Shape : Ø72.0
Direct Injection
Pin : 55.0 Length : 109.0

STD



Piston Ring

OEM NO. ME120536
NPR : SDM31-056ZZ

OEM Ring Groove

SIZE

Top : 3.3DK
2nd : 3.0
Oil : 4.0

STD



Cylinder Liner

OEM NO. ME120028

Liner&Sleeve

SIZE

In Diameter : 135.0
Out Diameter : 140.0
Total length : 261.0
Flange : 149.0*9.0+1.3

STD



Engine Bearing

MAIN :
CON.ROD :
T/W :
C/B :
BUSH :

SIZE

STD



Engine Valve

OEM NO. ME120529
IN 46.0 10.0 185.2
OEM NO. ME350711
EX 46.0 10.0 185.5

SIZE

STD

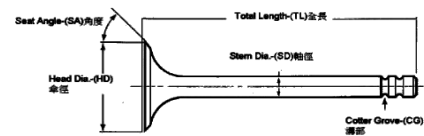

Valve Seat

OEM NO. ME160602
IN 49.0 39.9 7.1
OEM NO. ME120752
EX 49.0 39.2 7.1

SIZE

STD

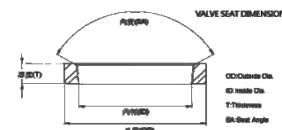

Valve Guide

OEM NO. 31101-00601
IN/EX 95.0 10.0 15.0

SIZE

STD

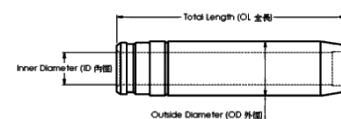

Gasket Set

OEM NO.



Piston kit-Set

OEM NO. 30017-82101

Piston	SIZE
Comp : 77.5 Height : -2.7 Length : 152.5 Top Shape : Flower Pin : 40.0 Length : 95.0	STD

Piston Ring

OEM NO. 30017-71002
NPR : SJM31-005ZZ

OEM Ring Groove	SIZE
Top : 3.5 2nd : 2.5 3rd : 2.5 Oil : 5.0	STD



Cylinder Liner

OEM NO. 30007-62200

Liner&Sleeve	SIZE
In Diameter : 110.0 Out Diameter : 125.0 Total length : 270.0 Flange : 135.0*11.8+1.5	STD



Engine Bearing

MAIN : 30009-39004
CON.ROD : 30019-12020
T/W : 30009-18104
C/B :
BUSH : 30019-20601

SIZE
STD



Engine Valve

OEM NO. 30004-23101
IN 53.0 12.0 176.5
OEM NO. 30004-31101
EX 45.0 12.0 176.5

SIZE
STD

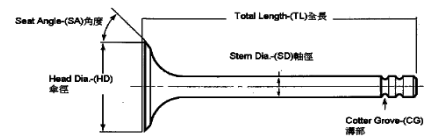

Valve Seat

OEM NO. 30001-23401
IN 54.5 48.0 6.8
OEM NO. 30001-23593
EX 46.5 40.0 6.8

SIZE
STD

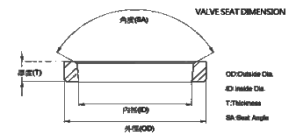

Valve Guide

OEM NO. 31101-00601
IN 83.0 12.0 20.0
OEM NO. 30001-10603/02
EX 93.5 12.0 20.0

SIZE
STD

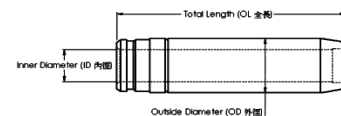

Gasket Set

OEM NO.



Piston kit-Set

OEM NO. 30017-70102

Piston	SIZE
Comp : 77.5 Height : -16.2 Length : 139.7 Shape : Flower Pin : 40.0 Length : 94.0	STD

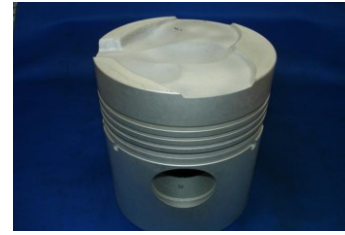

Piston Ring

OEM NO. 30017-71002
NPR : SJM31-005ZZ

OEM Ring Groove	SIZE
Top : 3.5 2nd : 2.5 3rd : 2.5 Oil : 5.0	STD



Cylinder Liner

OEM NO. 30007-62200

Liner&Sleeve	SIZE
In Diameter : 110.0 Out Diameter : 125.0 Total length : 270.0 Flange : 135.0*11.8+1.5	STD



Engine Bearing

MAIN : 30009-39004
CON.ROD : 30019-12020
T/W : 30009-18104
C/B :
BUSH : 30019-20601

SIZE
STD



Engine Valve

OEM NO. 30004-23101
IN 53.0 12.0 176.5
OEM NO. 30004-31101
EX 45.0 12.0 176.5

SIZE
STD

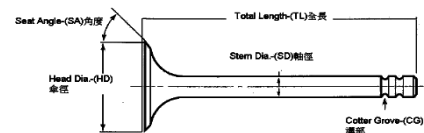

Valve Seat

OEM NO. 30001-23401
IN 54.5 48.0 6.8
OEM NO. 30001-23593
EX 46.5 40.0 6.8

SIZE
STD

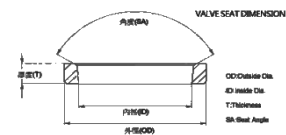

Valve Guide

OEM NO. 31101-00601
IN 83.0 12.0 20.0
OEM NO. 30001-10603/30001-10602
EX 93.5 12.0 20.0

SIZE
STD

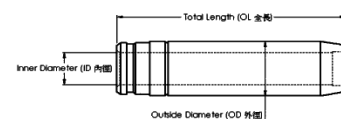

Gasket Set

OEM NO.



Piston kit-Set

OEM NO. ME023255

Piston

SIZE

Comp : 60.5 Height : -8.7 Length : 105.35
 Shape : Flower
 Pin : 32.0
 Length : 82.0

STD

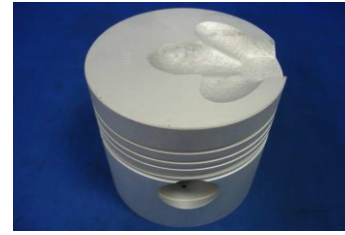

Piston Ring

OEM NO. ME020382
 NPR : SJM30-002ZZ

OEM Ring Groove

SIZE

Top : 2.5
 2nd : 2.0
 3rd : 2.0
 Oil : 4.5

STD



Cylinder Liner

OEM NO. ME020306

Liner&Sleeve

SIZE

In Diameter : 95.0
 Out Diameter : 108.0
 Total length : 191.2
 Flange : 115.0*10.0+1.2

STD



Engine Bearing

MAIN : ME025265
 CON.ROD : ME025292
 T/W : ME020328
 C/B :
 BUSH : ME020448

SIZE

STD



Engine Valve

OEM NO. ME020236
 IN 46.0 9.0 137.0
 OEM NO. ME021039
 EX 37.0 9.0 137.0

SIZE

STD

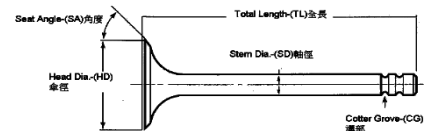

Valve Seat

OEM NO. ME020224/ME024207
 IN
 OEM NO. ME020226
 EX

SIZE

STD

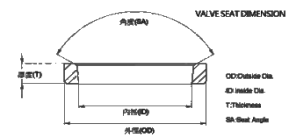

Valve Guide

OEM NO. MD031886
 IN 64.0 9.0 15.0
 OEM NO. MD031888
 EX 71.5 9.0 15.0

SIZE

STD

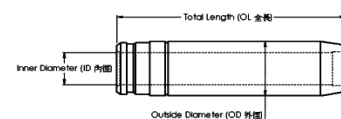

Gasket Set

OEM NO.



Piston kit-Set

OEM NO. ME023267

Piston	SIZE
Comp : 60.75 Height : -9.7 Length : 105.5 Shape : Flower Pin : 32.0 Length : 82.0	STD



Piston Ring

OEM NO. ME021855
NPR : SJM30-001ZZ

OEM Ring Groove	SIZE
Top : 3.0K 2nd : 2.0 Oil : 4.5	STD



Cylinder Liner

OEM NO. ME020306

Liner&Sleeve	SIZE
In Diameter : 95.0 Out Diameter : 108.0 Total length : 191.2 Flange : 115.0*10.0+1.2	STD



Engine Bearing

MAIN : ME025265
CON.ROD : ME025292
T/W : ME020328
C/B :
BUSH : ME020448

SIZE
STD



Engine Valve

OEM NO. ME020236
IN 46.0 9.0 137.0
OEM NO. ME021039
EX 37.0 9.0 137.0

SIZE
STD

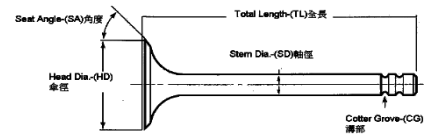

Valve Seat

OEM NO. ME020224
IN
OEM NO. ME020226
EX

SIZE
STD

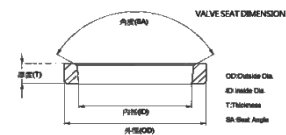

Valve Guide

OEM NO. MD031886
IN 64.0 9.0 15.0
OEM NO. MD031888
EX 71.5 9.0 15.0

SIZE
STD

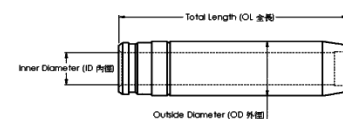

Gasket Set

OEM NO.



Piston kit-Set

OEM NO. ME023274

Piston	SIZE
Comp : 60.7 Height : -9.3 Length : 105.2 Shape : Flower Pin : 32.0 Length : 82.0	STD

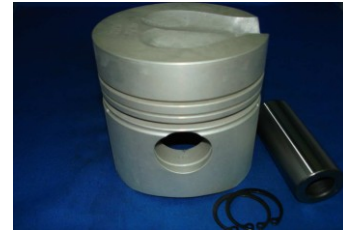

Piston Ring

 OEM NO. ME023333
 NPR : SDM31-002ZZ

OEM Ring Groove	SIZE
Top : 3.0 2nd : 2.0 Oil : 5.0	STD



Cylinder Liner

OEM NO. ME021843

Liner&Sleeve	SIZE
In Diameter : 98.0 Out Diameter : 110.0 Total length : 201.2 Flange : 117.0*10.0+1.2	STD



Engine Bearing

 MAIN : ME025265
 CON.ROD : ME025292
 T/W : ME020328
 C/B :
 BUSH : ME020448

SIZE
STD



Engine Valve

 OEM NO. ME020236
 IN 46.0 9.0 137.0
 OEM NO. ME021039
 EX 37.0 9.0 137.0

SIZE
STD

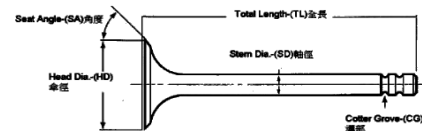

Valve Seat

 OEM NO. ME020224/ME024207
 IN 49.0 41.2 6.5
 OEM NO. ME020226/ME022819
 EX 39.0 31.9 6.5

SIZE
STD

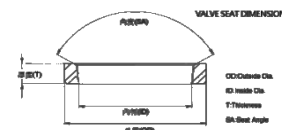

Valve Guide

 OEM NO. MD031886
 IN 64.0 9.0 15.0
 OEM NO. MD031888
 EX 71.5 9.0 15.0

SIZE
STD

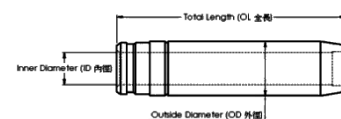

Gasket Set

OEM NO.



Piston kit-Set

OEM NO. ME023274

Piston	SIZE
Comp : 60.7 Height : -9.3 Length : 105.2 Shape : Flower Pin : 32.0 Length : 82.0	STD

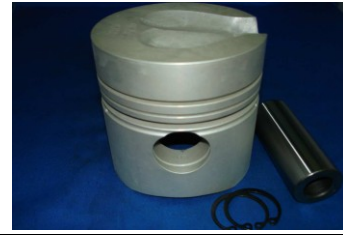

Piston Ring

OEM NO. ME023333
NPR : SDM31-002ZZ

OEM Ring Groove	SIZE
Top : 3.0 2nd : 2.0 Oil : 5.0	STD



Cylinder Liner

OEM NO. ME029187

Liner&Sleeve	SIZE
In Diameter : 98.0 Out Diameter : 110.0 Total length : 206.2 Flange : 117.0*10.0+1.2	STD



Engine Bearing

MAIN : ME025265
CON.ROD : ME025292
T/W : ME020328
C/B :
BUSH : ME020448

SIZE
STD



Engine Valve

OEM NO. ME020236
IN 46.0 9.0 137.0
OEM NO. ME021039
EX 37.0 9.0 137.0

SIZE
STD

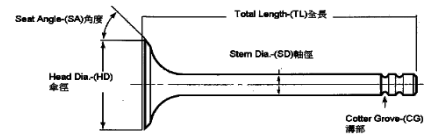

Valve Seat

OEM NO. ME020224/ME024207
IN 49.0 41.2 6.5
OEM NO. ME020226/ME022819
EX 39.0 31.9 6.5

SIZE
STD

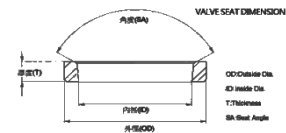

Valve Guide

OEM NO. MD031886
IN 64.0 9.0 15.0
OEM NO. MD031888
EX 71.5 9.0 15.0

SIZE
STD

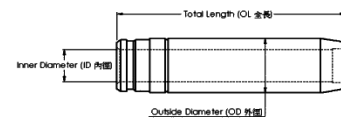

Gasket Set

OEM NO.



Piston kit-Set

OEM NO. ME131943

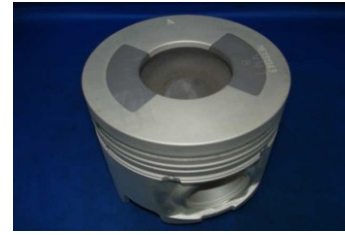

Piston

SIZE

 Comp : 71.2 w/al-fin Height : -23.5 oil-cooled Length : 116.1
 Shape : Ø53.0
 Pin : 42.0
 Length : 92.5

STD

Piston Ring

 OEM NO. ME995563
 NPR : SDM31-107ZY

OEM Ring Groove

SIZE

 Top : 2.806DK
 2nd : 2.5
 Oil : 4.0

STD

Cylinder Liner

OEM NO.



Liner&Sleeve

SIZE

 In Diameter : 118.0
 Out Diameter :
 Total length :
 Flange :

STD

Engine Bearing

 MAIN : MS-1838GP
 CON.ROD : CB-1820GP
 T/W :
 C/B :
 BUSH :

SIZE

STD

Engine Valve

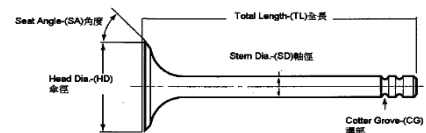
 OEM NO. ME240748
 IN 40.0 8.0 141.5
 OEM NO. ME240461
 EX 36.0 8.0 141.5

SIZE

STD

Valve Seat

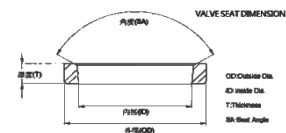
 OEM NO.
 IN
 OEM NO.
 EX

SIZE

STD

Valve Guide

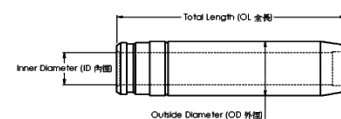
 OEM NO. ME302156
 IN 69.0 8.0 13.0
 OEM NO. ME240032
 EX 74.0 8.0 13.0

SIZE

STD

Gasket Set

OEM NO.



Piston kit-Set

OEM NO. ME305671



Piston

SIZE

Comp : 71.0 w/al-fin Height : -13.8 oil-cooled
 Length : 116.1 MOS2 Shape : Ø79.0
 Direct Injection
 Pin : 42.0 Length : 92.5

STD

Piston Ring

OEM NO. ME995563
 NPR : SDM31-107ZY



OEM Ring Groove

SIZE

Top : 2.806DK
 2nd : 2.5
 Oil : 4.0

STD

Cylinder Liner

OEM NO.



Liner&Sleeve

SIZE

In Diameter : 118.0
 Out Diameter :
 Total length :
 Flange :

STD

Engine Bearing

MAIN : MS-1838GP
 CON.ROD : CB-1820GP
 T/W :
 C/B :
 BUSH :



SIZE

STD

Engine Valve

OEM NO. ME240748
 IN 40.0 8.0 141.65
 OEM NO. ME240461
 EX 36.0 8.0 141.4

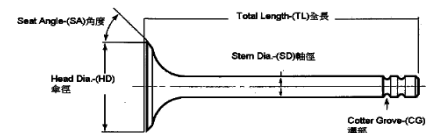

SIZE

STD

Valve Seat

OEM NO.
 IN
 OEM NO.
 EX

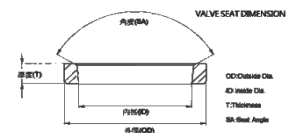

SIZE

STD

Valve Guide

OEM NO. ME302156
 IN 69.0 8.0 13.0
 OEM NO. ME240032
 EX 74.0 8.0 13.0

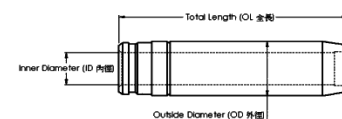

SIZE

STD

Gasket Set

OEM NO.



Piston kit-Set

OEM NO. ME351865

Piston

SIZE

Comp : 71.0 w/al-fin Height : -18.3 oil-cooled Length : 152.0
Shape : Ø90.0
Direct Injection Head Anodized
Pin : 55.0 Length : 109.0

STD

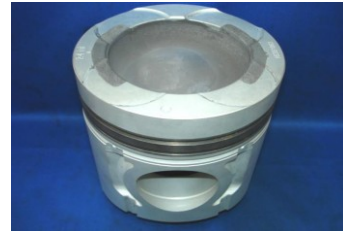

Piston Ring

OEM NO. ME995857
NPR : SDM31-115ZZ

OEM Ring Groove

SIZE

Top : 3.306DK
2nd : 2.5
Oil : 4.0

STD



Cylinder Liner

OEM NO. ME180960

Liner&Sleeve

SIZE

In Diameter : 135.0
Out Diameter : 140.0
Total length : 260.6
Flange : 149.0*9.0+1.0

STD



Engine Bearing

MAIN :
CON.ROD :
T/W :
C/B :
BUSH :

SIZE

STD



Engine Valve

OEM NO. ME181123
IN 46.0 10.0 192.0
OEM NO. ME352611
EX 46.0 10.0 192.25

SIZE

STD

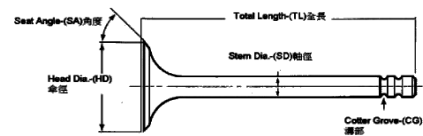

Valve Seat

OEM NO.
IN
OEM NO.
EX

SIZE

STD

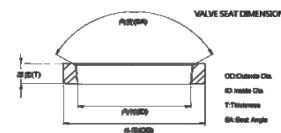

Valve Guide

OEM NO. ME120085
IN 95.0 10.0 15.0
OEM NO. ME120087
EX 95.0 10.0 15.0

SIZE

STD

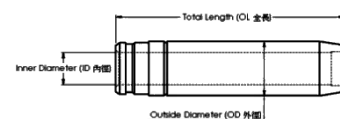

Gasket Set

OEM NO.



Piston kit-Set

OEM NO. ME355100

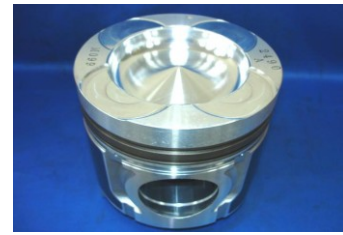

Piston

SIZE

Comp : 76.9 w/al-fin Height : -20.0 oil-cooled
Length : 151.9 MOS2 Shape : Ø90.0
Direct Injection
Pin : 55.0 Length : 109.0

STD

Piston Ring

OEM NO. ME995857
NPR : SDM31-115ZZ



OEM Ring Groove

SIZE

Top : 3.306DK
2nd : 2.5
Oil : 4.0

STD

Cylinder Liner

OEM NO. ME180960



Liner&Sleeve

SIZE

In Diameter : 135.0
Out Diameter : 140.0
Total length : 260.6
Flange : 149.0*9.0+1.0

STD

Engine Bearing

MAIN :
CON.ROD :
T/W :
C/B :
BUSH :



SIZE

STD

Engine Valve

OEM NO. ME181123
IN 46.0 10.0 192.0
OEM NO. ME352611
EX 46.0 10.0 192.25

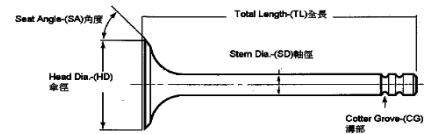

SIZE

STD

Valve Seat

OEM NO.
IN
OEM NO.
EX

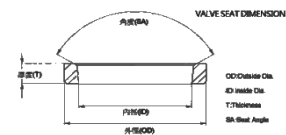

SIZE

STD

Valve Guide

OEM NO. ME120085
IN 95.0 10.0 15.0
OEM NO. ME120087
EX 95.0 10.0 15.0

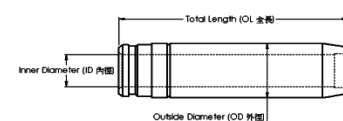

SIZE

STD

Gasket Set

OEM NO.



Piston kit-Set

OEM NO. ME062273

Piston

SIZE

Comp : 79.5 w/al-fin Height : -21.7 Length : 145.5
Shape : Ø73.0
Direct Injection
Pin : 45.0 Length : 108.0

STD



Piston Ring

OEM NO. ME062298
NPR : SDM31-020ZZ

OEM Ring Groove

SIZE

Top : 3.3DK
2nd : 3.0
Oil : 6.0

STD



Cylinder Liner

OEM NO. 31207-72603

Liner&Sleeve

SIZE

In Diameter : 130.0
Out Diameter : 147.0
Total length : 229.3
Flange : 157.0*11.8+1.3

STD



Engine Bearing

MAIN : 31209-70020
CON.ROD : 31219-51000
T/W : 31109-07109
C/B :
BUSH : 31219-05501

SIZE

STD



Engine Valve

OEM NO. 31104-00101
IN 62.0 12.0 175.0
OEM NO. 31104-01103
EX 50.0 12.0 175.0

SIZE

STD

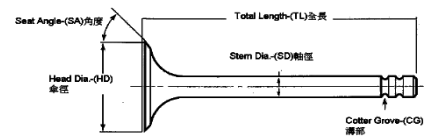

Valve Seat

OEM NO. 31201-70192
IN 64.0 55.0 7.0
OEM NO. 31101-00501
EX 52.0 43.0 7.0

SIZE

STD

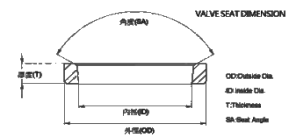

OEM NO. 31101-00601
IN 83.0 12.0 20.0
OEM NO. 31201-30700
EX 93.5 12.0 20.0

SIZE

STD

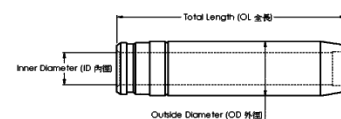

Gasket Set

OEM NO.



Piston kit-Set

OEM NO. 31217-78101

Piston	SIZE
Comp : 77.8 w/al-fin Height : Length : 145.8 Shape : Ø Direct Injection Pin : 45.0 Length : 108.0	STD

Piston Ring

OEM NO. 31217-60012
NPR : SDM31-004ZZ

OEM Ring Groove	SIZE
Top : 4.0K 2nd : 3.0 Oil : 6.0	STD



Cylinder Liner

OEM NO. 31207-63200

Liner&Sleeve	SIZE
In Diameter : 135.0 Out Diameter : 154.0 Total length : 229.3 Flange : 163.0*11.8+1.3	STD



Engine Bearing

MAIN : 31209-70020
CON.ROD : 31219-51000
T/W : 31109-07109
C/B :
BUSH : 31219-05501

SIZE
STD



Engine Valve

OEM NO. 31104-00101
IN 62.0 12.0 175.0
OEM NO. 31104-01103
EX 50.0 12.0 175.0

SIZE
STD

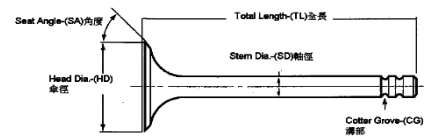

Valve Seat

OEM NO. 31201-70192
IN 64.0 55.0 7.0
OEM NO. 31101-00501
EX 52.0 43.0 7.0

SIZE
STD

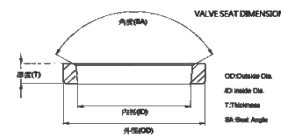

Valve Guide

OEM NO. 31101-00601
IN 83.0 12.0 20.0
OEM NO. 31201-30700
EX 93.5 12.0 20.0

SIZE
STD

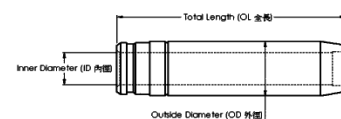

Gasket Set

OEM NO.



Piston kit-Set

OEM NO. ME062280

Piston	SIZE
Comp : 78.0 w/al-fin Height : Length : 143.0 Shape : Ø73.0 Direct Injection Pin : 45.0 Length : 108.0	STD

Piston Ring

OEM NO. ME062298
 NPR : SDM31-020ZZ

OEM Ring Groove	SIZE
Top : 4.0K 2nd : 3.0 Oil : 6.0	STD



Cylinder Liner

OEM NO.

Liner&Sleeve	SIZE
In Diameter : Out Diameter : Total length : Flange :	STD



Engine Bearing

MAIN : 31209-70020
 CON.ROD : 31219-51000
 T/W : 31109-07109
 C/B :
 BUSH : 31219-05501

SIZE
 STD



Engine Valve

OEM NO. ME061545
 IN 59.0 12.0 174.7
 OEM NO. ME061547
 EX 53.0 12.0 175.0

SIZE
 STD

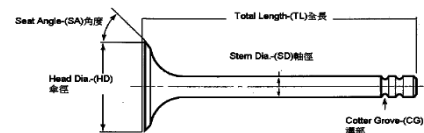

Valve Seat

OEM NO. 31201-30491
 IN 61.0 52.0 7.3
 OEM NO. 31201-30591
 EX 55.0 46.0 7.3

SIZE
 STD

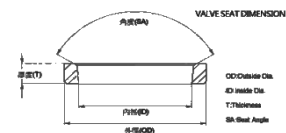

Valve Guide

OEM NO. ME051120
 IN 83.0 12.0 20.0
 OEM NO. ME051122
 EX 93.5 5.0 20.0

SIZE
 STD

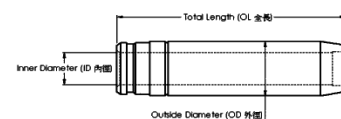

Gasket Set

OEM NO.



Piston kit-Set

OEM NO. 31217-74102 / 31217-67106 / 31217-68104 / ME062287

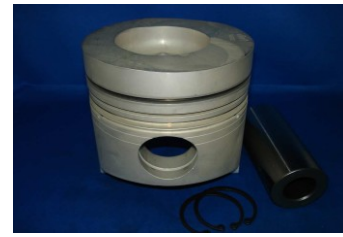

Piston

SIZE

Comp : 77.6 w/al-fin Height : -27.0 Length : 143.0
Shape : Ø75.0
Direct Injection
Pin : 45.0 Length : 108.0

STD

Piston Ring

OEM NO. 31217-60012
NPR : SDM31-004ZZ



OEM Ring Groove

SIZE

Top : 4.0K
2nd : 3.0
Oil : 6.0

STD

Cylinder Liner

OEM NO. 31207-72183



Liner&Sleeve

SIZE

In Diameter : 135.0
Out Diameter : 154.0
Total length : 229.3
Flange : 163.0*11.8+1.3

STD

Engine Bearing

MAIN : 31209-70020
CON.ROD : 31219-51000
T/W : 31109-07109
C/B :
BUSH : 31219-05501



SIZE

STD

Engine Valve

OEM NO. 31104-00101
IN 62.0 12.0 174.5
OEM NO. 31104-01103
EX 50.0 12.0 175.0

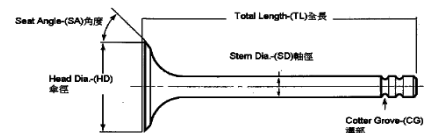

SIZE

STD

Valve Seat

OEM NO. 31201-70192
IN 64.0 55.0 7.0
OEM NO. 31101-00501
EX 52.0 43.0 7.0

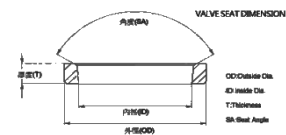

SIZE

STD

Valve Guide

OEM NO. 31101-00601
IN 83.0 12.0 20.0
OEM NO. 31201-30700
EX 93.5 12.0 20.0

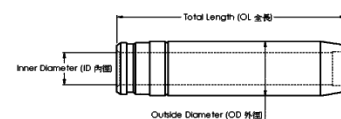

SIZE

STD

Gasket Set

OEM NO.



MITSUBISHI 8DC9

Application : TRUCK BUS
Number of Cylinders 8
Cylinder dia. 135.0 MM
Swept Volume 16031 ccm

Piston kit-Set

OEM NO. ME062408



Piston

SIZE

Comp : 88.1 w/al-fin Height : -25.40 Length : 153.0
Shape : Ø75.3
Direct Injection
Pin : 50.0 Length : 112.0

STD

Piston Ring

OEM NO. ME062018
NPR : SDM31-029ZZ



OEM Ring Groove

SIZE

Top : 3.3DK
2nd : 3.0
3rd : 3.0
Oil : 6.0

STD

Cylinder Liner

OEM NO. ME061782



Liner&Sleeve

SIZE

In Diameter : 135.0
Out Diameter : 155.0
Total length : 259.3
Flange : 163.0*11.8+1.7

STD

Engine Bearing

MAIN : 31209-70020
CON.ROD : 31219-32010
T/W : 31109-33100
C/B :
BUSH : 31219-34300



SIZE

STD

Engine Valve

OEM NO. ME061545
IN 59.0 12.0 174.7
OEM NO. ME061547
EX 53.0 12.0 175.0

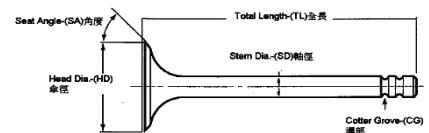

SIZE

STD

Valve Seat

OEM NO. 31201-30491
IN 61.0 52.0 7.3
OEM NO. 31201-30591
EX 55.0 46.0 7.3

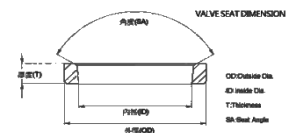

SIZE

STD

Valve Guide

OEM NO. 31101-00601
IN 83.0 12.0 20.0
OEM NO. 31201-30700
EX 93.5 12.0 20.0

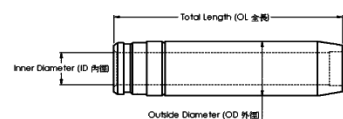

SIZE

STD

Gasket Set

OEM NO.



Piston kit-Set

OEM NO. ME062684



Piston

SIZE

Comp : 88.3 w/al-fin Height : -24.0 Length : 153.0
Shape : Ø78.0
Direct Injection
Pin : 50.0 Length : 112.0

STD

Piston Ring

OEM NO. ME062018
NPR : SDM31-029ZZ



OEM Ring Groove

SIZE

Top : 3.3DK
2nd : 3.0
3rd : 3.0
Oil : 6.0

STD

Cylinder Liner

OEM NO. ME061782



Liner&Sleeve

SIZE

In Diameter : 135.0
Out Diameter : 155.0
Total length : 259.3
Flange : 163.0*11.8+1.7

STD

Engine Bearing

MAIN : 31209-70020
CON.ROD : 31219-32010
T/W : 31109-33100
C/B :
BUSH : 31219-34300



SIZE

STD

Engine Valve

OEM NO. ME061545
IN 59.0 12.0 174.7
OEM NO. ME061547
EX 53.0 12.0 175.0

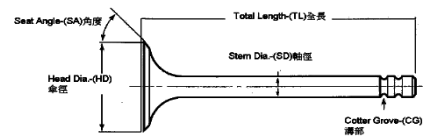

SIZE

STD

Valve Seat

OEM NO. 31201-30491
IN 61.0 52.0 7.3
OEM NO. 31201-30591
EX 55.0 46.0 7.3

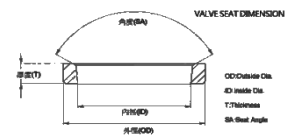

SIZE

STD

Valve Guide

OEM NO. 31101-00601
IN 83.0 12.0 20.0
OEM NO. 31201-30700
EX 93.5 12.0 20.0

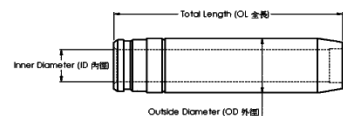

SIZE

STD

Gasket Set

OEM NO.



Piston kit-Set

OEM NO. ME091311

Piston	SIZE
Comp : 88.0 w/al-fin Height : Length : 153.0 Shape : Ø78.5 Direct Injection Pin : 50.0 Length : 112.0	STD

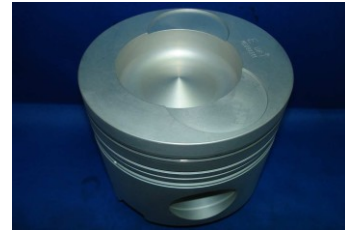

Piston Ring

OEM NO. ME062018
NPR : SDM31-029ZZ

OEM Ring Groove	SIZE
Top : 3.3DK 2nd : 3.0 3rd : 3.0 Oil : 6.0	STD



Cylinder Liner

OEM NO. ME061782

Liner&Sleeve	SIZE
In Diameter : 135.0 Out Diameter : 155.0 Total length : 259.3 Flange : 163.0*11.8+1.7	STD



Engine Bearing

MAIN : 31209-70020
CON.ROD : 31219-32010
T/W : 31109-33100
C/B :
BUSH : 31219-34300

SIZE
STD



Engine Valve

OEM NO. ME061545
IN 59.0 12.0 174.7
OEM NO. ME061547
EX 53.0 12.0 175.0

SIZE
STD

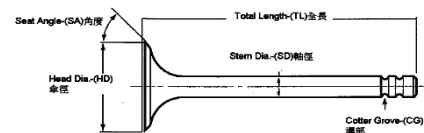

Valve Seat

OEM NO. 31201-30491
IN 61.0 52.0 7.3
OEM NO. 31201-30591
EX 55.0 46.0 7.3

SIZE
STD

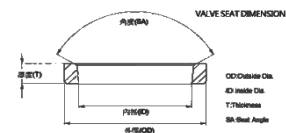

Valve Guide

OEM NO. 31101-00601
IN 83.0 12.0 20.0
OEM NO. 31201-30700
EX 93.5 12.0 20.0

SIZE
STD

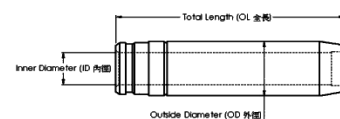

Gasket Set

OEM NO.



MITSUBISHI

8DC9TN(3V)

Application : TRUCK BUS
Number of Cylinders 8
Cylinder dia. 135.0 MM
Swept Volume 16031 ccm

Piston kit-Set

OEM NO. ME092922

Piston	SIZE
Comp : 88.3 w/al-fin Height : -25.6 Length : 153.1 Shape : Ø79.0 Direct Injection Pin : 50.0 Length : 112.0	STD



Piston Ring

OEM NO. ME090758
 NPR : SDM31-087ZZ

OEM Ring Groove	SIZE
Top : 3.3DK 2nd : 3.0 3rd : 3.0 Oil : 6.0	STD



Cylinder Liner

OEM NO. ME061782

Liner&Sleeve	SIZE
In Diameter : 135.0 Out Diameter : 155.0 Total length : 259.3 Flange : 163.0*11.8+1.7	STD



Engine Bearing

MAIN : 31209-70020
 CON.ROD : 31219-32010
 T/W : 31109-33100
 C/B :
 BUSH : 31219-34300

SIZE
 STD



Engine Valve

OEM NO. ME061545
 IN 59.0 12.0 174.7
 OEM NO. ME061547
 EX 53.0 12.0 175.0

SIZE
 STD

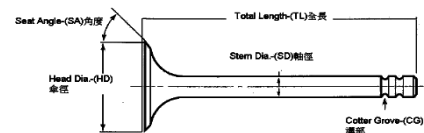

Valve Seat

OEM NO. 31201-30491
 IN 61.0 52.0 7.3
 OEM NO. 31201-30591
 EX 55.0 46.0 7.3

SIZE
 STD

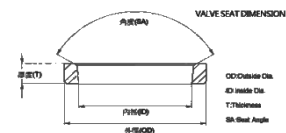

Valve Guide

OEM NO. 31101-00601
 IN 83.0 12.0 20.0
 OEM NO. 31201-30700
 EX 93.5 12.0 20.0

SIZE
 STD

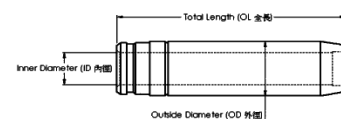

Gasket Set

OEM NO.



MITSUBISHI 8DC10(3V)

Application : TRUCK BUS
Number of Cylinders 8
Cylinder dia. 138.0 MM
Swept Volume 16752 ccm

Piston kit-Set

OEM NO. ME092649



Piston

SIZE

Comp : 88.3 w/al-fin Height : -24.8 Length : 153.1
Shape : Ø74.3
Direct Injection
Pin : 50.0 Length : 112.0

STD

Piston Ring

OEM NO. ME090582
NPR : SDM31-139ZZ



OEM Ring Groove

SIZE

Top : 3.3DK
2nd : 3.0
3rd : 3.0
Oil : 4.0

STD

Cylinder Liner

OEM NO. ME062783



Liner&Sleeve

SIZE

In Diameter : 138.0
Out Diameter : 154.0
Total length : 259.7
Flange : 163.0*11.8+1.7

STD

Engine Bearing

MAIN : 31209-70020
CON.ROD : 31219-32010
T/W : 31109-33100
C/B :
BUSH : 31219-34300



SIZE

STD

Engine Valve

OEM NO.
IN
OEM NO.
EX

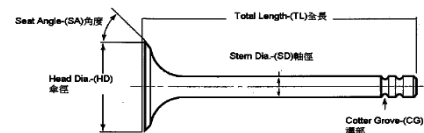

SIZE

STD

Valve Seat

OEM NO.
IN
OEM NO.
EX

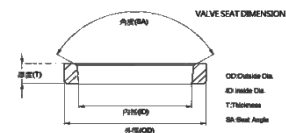

SIZE

STD

Valve Guide

OEM NO.
IN
OEM NO.
EX

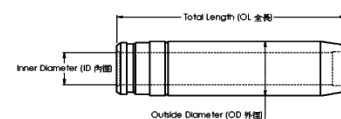

SIZE

STD

Gasket Set

OEM NO.



Piston kit-Set

OEM NO. ME090146

Piston	SIZE
Comp : 88.1 w/al-fin Height : Length : 153.1 Shape : Ø Direct Injection Pin : 50.0 Length : 112.0	STD

Piston Ring

OEM NO. ME065717
NPR : SDM31-134ZZ

OEM Ring Groove	SIZE
Top : 3.3DK 2nd : 3.0 3nd : 3.0 Oil : 6.0	STD



Cylinder Liner

OEM NO. ME062783

Liner&Sleeve	SIZE
In Diameter : 138.0 Out Diameter : 154.0 Total length : 259.7 Flange : 163.0*11.8+1.7	STD



Engine Bearing

MAIN : 31209-70020
CON.ROD : 31219-32010
T/W : 31109-33100
C/B :
BUSH : 31219-34300

SIZE
STD



Engine Valve

OEM NO.
IN
OEM NO.
EX

SIZE
STD

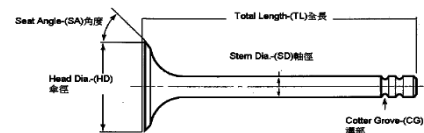

Valve Seat

OEM NO.
IN
OEM NO.
EX

SIZE
STD

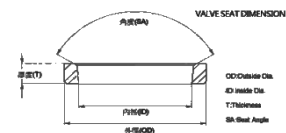

Valve Guide

OEM NO.
IN
OEM NO.
EX

SIZE
STD

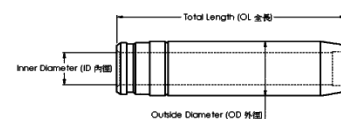

Gasket Set

OEM NO.



Piston kit-Set

OEM NO. ME090230

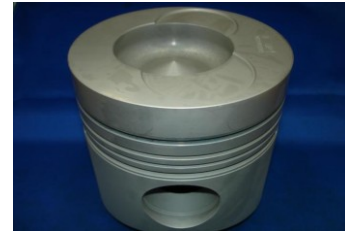

Piston

SIZE

Comp : 88.1 w/al-fin Height : -25.1 Length : 153.1
Shape : Ø74.0
Direct Injection
Pin : 50.0 Length : 112.0

STD

Piston Ring

OEM NO. ME090582
NPR : SDM31-139ZZ



OEM Ring Groove

SIZE

Top : 3.3DK
2nd : 3.0
3rd : 3.0
Oil : 4.0

STD

Cylinder Liner

OEM NO. ME062783



Liner&Sleeve

SIZE

In Diameter : 138.0
Out Diameter : 154.0
Total length : 259.7
Flange : 163.0*11.8+1.7

STD

Engine Bearing

MAIN : 31209-70020
CON.ROD : 31219-32010
T/W : 31109-33100
C/B :
BUSH : 31219-34300



SIZE

STD

Engine Valve

OEM NO.
IN
OEM NO.
EX

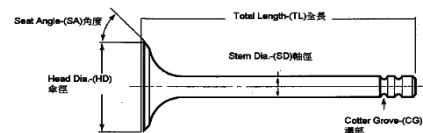

SIZE

STD

Valve Seat

OEM NO.
IN
OEM NO.
EX

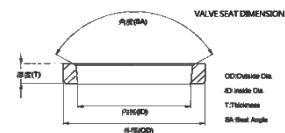

SIZE

STD

Valve Guide

OEM NO.
IN
OEM NO.
EX

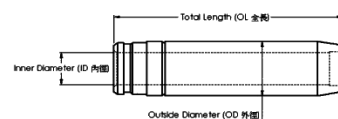

SIZE

STD

Gasket Set

OEM NO.



MITSUBISHI 8DC10(2V)

Application : TRUCK BUS
Number of Cylinders 8
Cylinder dia. 138.0 MM
Swept Volume 16752 ccm

Piston kit-Set

OEM NO. ME091049



Piston

SIZE

Comp : 88.3 w/al-fin Height : -24.0 Length : 153.1
Shape : Ø74.3
Direct Injection
Pin : 50.0 Length : 112.0

STD

Piston Ring

OEM NO. ME090582
NPR : SDM31-139ZZ



OEM Ring Groove

SIZE

Top : 3.3DK
2nd : 3.0
3rd : 3.0
Oil : 4.0

STD

Cylinder Liner

OEM NO. ME062783



Liner&Sleeve

SIZE

In Diameter : 138.0
Out Diameter : 154.0
Total length : 259.7
Flange : 163.0*11.8+1.7

STD

Engine Bearing

MAIN : 31209-70020
CON.ROD : 31219-32010
T/W : 31109-33100
C/B :
BUSH : 31219-34300



SIZE

STD

Engine Valve

OEM NO.
IN
OEM NO.
EX

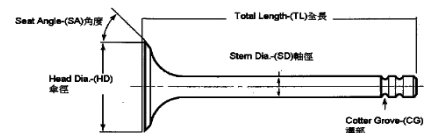

SIZE

STD

Valve Seat

OEM NO.
IN
OEM NO.
EX

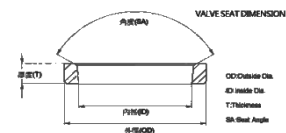

SIZE

STD

Valve Guide

OEM NO.
IN
OEM NO.
EX

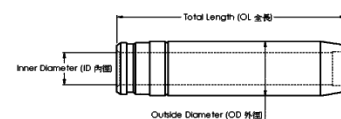

SIZE

STD

Gasket Set

OEM NO.



MITSUBISHI

8DC11(3V)

Application : TRUCK BUS
Number of Cylinders 8
Cylinder dia. 142.0 MM
Swept Volume 17737 ccm

Piston kit-Set

OEM NO. ME090165

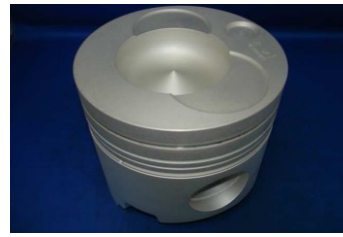

Piston

SIZE

Comp : 88.1 w/al-fin Height : -25.7 Length : 153.1
Shape : Ø76.0
Direct Injection
Pin : 50.0 Length : 112.0

STD

Piston Ring

OEM NO. ME090586
NPR : SDM31-128ZZ



OEM Ring Groove

SIZE

Top : 3.3DK
2nd : 3.0
3rd : 3.0
Oil : 4.0

STD

Cylinder Liner

OEM NO. ME060439



Liner&Sleeve

SIZE

In Diameter : 142.0
Out Diameter : 154.0
Total length : 257.7
Flange : 163.0

STD

Engine Bearing

MAIN : 31209-70020
CON.ROD : 31219-70600
T/W : 31209-33100
C/B :
BUSH : 31219-34300



SIZE

STD

Engine Valve

OEM NO. ME061545
IN 59.0 12.0 174.7
OEM NO. ME061547
EX 53.0 12.0 175.0

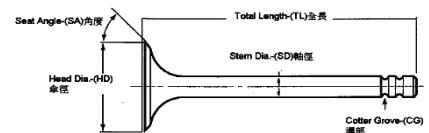

SIZE

STD

Valve Seat

OEM NO. 31201-30491
IN 61.0 52.0 7.3
OEM NO. 31201-30591
EX 55.0 46.0 7.3

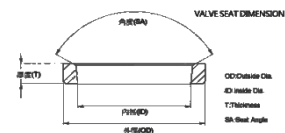

SIZE

STD

Valve Guide

OEM NO. 31101-00601
IN 83.0 12.0 20.0
OEM NO. 31201-30700
EX 93.5 12.0 20.0

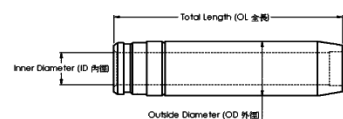

SIZE

STD

Gasket Set

OEM NO.



Piston kit-Set

OEM NO. ME091050



Piston	SIZE
Comp : 88.2 w/al-fin Height : -26.0 Length : 153.1 Shape : \varnothing 76.0 Direct Injection Pin : 50.0 Length : 112.0	STD

Piston Ring

OEM NO. ME090586
NPR : SDM31-128ZZ



OEM Ring Groove	SIZE
Top : 3.3DK 2nd : 3.0 3rd : 3.0 Oil : 4.0	STD

Cylinder Liner

OEM NO. ME060439



Liner&Sleeve	SIZE
In Diameter : 142.0 Out Diameter : 154.0 Total length : 257.7 Flange : 163.0	STD

Engine Bearing

MAIN : 31209-70020
CON.ROD : 31219-70600
T/W : 31209-33100
C/B :
BUSH : 31219-34300



	SIZE
	STD

Engine Valve

OEM NO. ME061545
IN 59.0 12.0 174.7
OEM NO. ME061547
EX 53.0 12.0 175.0

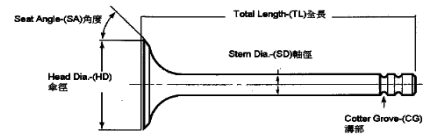

	SIZE
	STD

Valve Seat

OEM NO. 31201-30491
IN 61.0 52.0 7.3
OEM NO. 31201-30591
EX 55.0 46.0 7.3

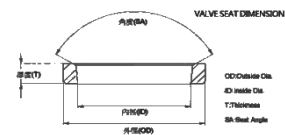

	SIZE
	STD

Valve Guide

OEM NO. 31101-00601
IN 83.0 12.0 20.0
OEM NO. 31201-30700
EX 93.5 12.0 20.0

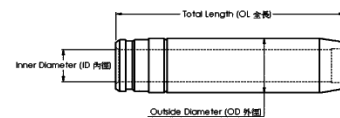

	SIZE
	STD

Gasket Set

OEM NO.



MITSUBISHI

8DC11(3V)

Application : TRUCK BUS
Number of Cylinders 8
Cylinder dia. 142.0 MM
Swept Volume 17737 ccm

Piston kit-Set

OEM NO. ME091052



Piston

SIZE

Comp : 88.4 w/al-fin Height : -24.9 Length : 153.1
Shape : Ø76.0
Direct Injection
Pin : 50.0 Length : 112.0

STD

Piston Ring

OEM NO. ME090586
NPR : SDM31-128ZZ



OEM Ring Groove

SIZE

Top : 3.3DK
2nd : 3.0
3rd : 3.0
Oil : 4.0

STD

Cylinder Liner

OEM NO. ME060439



Liner&Sleeve

SIZE

In Diameter : 142.0
Out Diameter : 154.0
Total length : 257.7
Flange : 163.0

STD

Engine Bearing

MAIN : 31209-70020
CON.ROD : 31219-70600
T/W : 31209-33100
C/B :
BUSH : 31219-34300

SIZE



STD

Engine Valve

OEM NO. ME061545
IN 59.0 12.0 174.7
OEM NO. ME061547
EX 53.0 12.0 175.0

SIZE

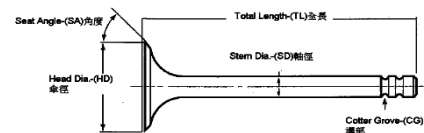

STD

Valve Seat

OEM NO. 31201-30491
IN 61.0 52.0 7.3
OEM NO. 31201-30591
EX 55.0 46.0 7.3

SIZE

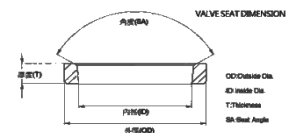

STD

Valve Guide

OEM NO. 31101-00601
IN 83.0 12.0 20.0
OEM NO. 31201-30700
EX 93.5 12.0 20.0

SIZE

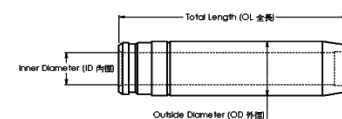

STD

Gasket Set

OEM NO.



Piston kit-Set

OEM NO. ME093426



Piston

SIZE

Comp : 88.3 w/al-fin Height : -28.8 Length : 153.1
Shape : Ø64.0
Direct Injection
Pin : 50.0 Length : 112.0

STD

Piston Ring

OEM NO. ME090586
NPR : SDM31-128ZZ



OEM Ring Groove

SIZE

Top : 3.3DK
2nd : 3.0
3rd : 3.0
Oil : 4.0

STD

Cylinder Liner

OEM NO. ME060439



Liner&Sleeve

SIZE

In Diameter : 142.0
Out Diameter : 154.0
Total length : 257.7
Flange : 163.0

STD

Engine Bearing

MAIN : 31209-70020
CON.ROD : 31219-70600
T/W : 31209-33100
C/B :
BUSH : 31219-34300



SIZE

STD

Engine Valve

OEM NO. ME061545
IN 59.0 12.0 174.7
OEM NO. ME061547
EX 53.0 12.0 175.0

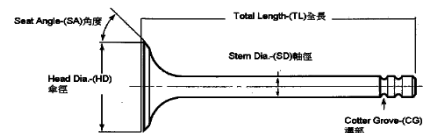

SIZE

STD

Valve Seat

OEM NO. 31201-30491
IN 61.0 52.0 7.3
OEM NO. 31201-30591
EX 55.0 46.0 7.3

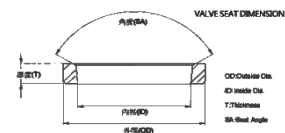

SIZE

STD

Valve Guide

OEM NO. 31101-00601
IN 83.0 12.0 20.0
OEM NO. 31201-30700
EX 93.5 12.0 20.0

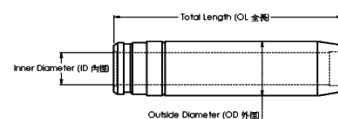

SIZE

STD

Gasket Set

OEM NO.



MITSUBISHI

8DC11(3V)

Application : TRUCK BUS
Number of Cylinders 8
Cylinder dia. 142.0 MM
Swept Volume 17737 ccm

Piston kit-Set

OEM NO. ME093427

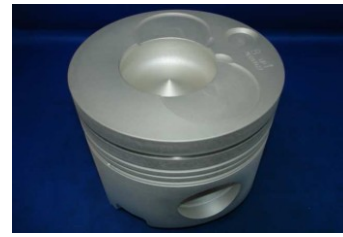

Piston

SIZE

Comp : 88.1 w/al-fin Height : -28.9 Length : 153.1
 Shape : Ø64.0
 Direct Injection
 Pin : 50.0 Length : 112.0

STD

Piston Ring

OEM NO. ME090586
 NPR : SDM31-128ZZ



OEM Ring Groove

SIZE

Top : 3.3DK
 2nd : 3.0
 3rd : 3.0
 Oil : 4.0

STD

Cylinder Liner

OEM NO. ME060439



Liner&Sleeve

SIZE

In Diameter : 142.0
 Out Diameter : 154.0
 Total length : 257.7
 Flange : 163.0

STD

Engine Bearing

MAIN : 31209-70020
 CON.ROD : 31219-70600
 T/W : 31209-33100
 C/B :
 BUSH : 31219-34300



SIZE

STD

Engine Valve

OEM NO. ME061545
 IN 59.0 12.0 174.7
 OEM NO. ME061547
 EX 53.0 12.0 175.0

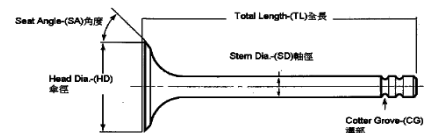

SIZE

STD

Valve Seat

OEM NO. 31201-30491
 IN 61.0 52.0 7.3
 OEM NO. 31201-30591
 EX 55.0 46.0 7.3

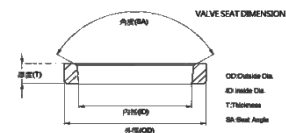

SIZE

STD

Valve Guide

OEM NO. 31101-00601
 IN 83.0 12.0 20.0
 OEM NO. 31201-30700
 EX 93.5 12.0 20.0

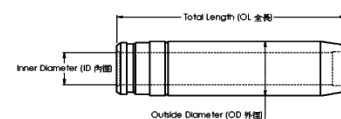

SIZE

STD

Gasket Set

OEM NO.



Piston kit-Set

OEM NO. ME062422



Piston

SIZE

Comp : 78.1 w/al-fin Height : -24.8 Length : 143.0
Shape : Ø72.9
Direct Injection
Pin : 45.0 Length : 108.0

STD

Piston Ring

OEM NO. ME062022
NPR : SDM31-028ZZ



OEM Ring Groove

SIZE

Top : 3.3DK
2nd : 3.0
Oil : 6.0

STD

Cylinder Liner

OEM NO. 31207-72183



Liner&Sleeve

SIZE

In Diameter : 135.0
Out Diameter : 154.0
Total length : 229.3
Flange : 163.0*11.8+1.3

STD

Engine Bearing

MAIN : 31209-70020
CON.ROD : 31219-51000
T/W : 31109-07109
C/B :
BUSH : 31219-05501



SIZE

STD

Engine Valve

OEM NO. 31104-00101
IN 62.0 12.0 174.5
OEM NO. 31104-01103
EX 50.0 12.0 175.0

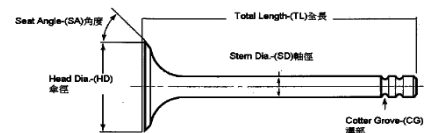

SIZE

STD

Valve Seat

OEM NO. 31101-00404
IN 64.0 55.0 7.0
OEM NO. 31101-00501
EX 52.0 43.0 7.0

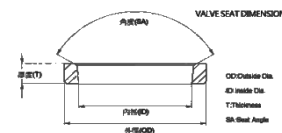

SIZE

STD

Valve Guide

OEM NO. 31101-00601
IN 83.0 12.0 20.0
OEM NO. 31201-30700
EX 93.5 12.0 20.0

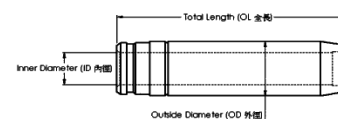

SIZE

STD

Gasket Set

OEM NO.



Piston kit-Set

OEM NO. ME062589



Piston

SIZE

Comp : 78.2 w/al-fin Height : -23.9 Length : 143.0
Shape : Ø70.8
Direct Injection
Pin : 45.0 Length : 108.0

STD

Piston Ring

OEM NO. ME062022
NPR : SDM31-028ZZ



OEM Ring Groove

SIZE

Top : 3.3DK
2nd : 3.0
Oil : 6.0

STD

Cylinder Liner

OEM NO. 31207-72183



Liner&Sleeve

SIZE

In Diameter : 135.0
Out Diameter : 154.0
Total length : 229.3
Flange : 163.0*11.8+1.3

STD

Engine Bearing

MAIN : 31209-70020
CON.ROD : 31219-51000
T/W : 31109-07109
C/B :
BUSH : 31219-05501



SIZE

STD

Engine Valve

OEM NO. 31104-00101
IN 62.0 12.0 174.5
OEM NO. 31104-01103
EX 50.0 12.0 175.0

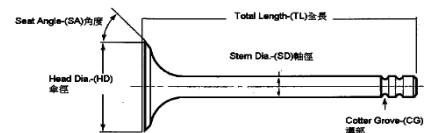

SIZE

STD

Valve Seat

OEM NO. 31101-00404
IN 64.0 55.0 7.0
OEM NO. 31101-00501
EX 52.0 43.0 7.0

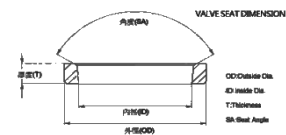

SIZE

STD

Valve Guide

OEM NO. 31101-00601
IN 83.0 12.0 20.0
OEM NO. 31201-30700
EX 93.5 12.0 20.0

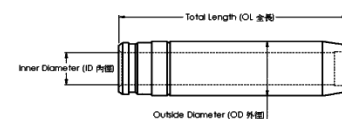

SIZE

STD

Gasket Set

OEM NO.



Piston kit-Set

OEM NO. ME062336



Piston

SIZE

Comp : 88.3 w/al-fin Height : -24.0 Length : 153.0
Shape : Ø73.1
Direct Injection
Pin : 50.0 Length : 112.0

STD

Piston Ring

OEM NO. ME062018
NPR : SDM31-029ZZ



OEM Ring Groove

SIZE

Top : 3.3DK
2nd : 3.0
3rd : 3.0
Oil : 6.0

STD

Cylinder Liner

OEM NO. ME061782



Liner&Sleeve

SIZE

In Diameter : 135.0
Out Diameter : 155.0
Total length : 259.3
Flange : 163.0*11.8+1.7

STD

Engine Bearing

MAIN : 31209-70020
CON.ROD : 31219-32010
T/W : 31209-33100
C/B :
BUSH : 31219-34300



SIZE

STD

Engine Valve

OEM NO. ME061545
IN 59.0 12.0 174.7
OEM NO. ME061547
EX 53.0 12.0 175.0

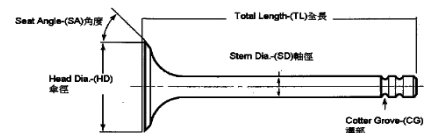

SIZE

STD

Valve Seat

OEM NO. 31201-30491
IN 61.0 52.0 7.3
OEM NO. 31201-30591
EX 55.0 46.0 7.3

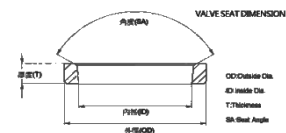

SIZE

STD

Valve Guide

OEM NO. 31101-00601
IN 83.0 12.0 20.0
OEM NO. 31201-30700
EX 93.5 12.0 20.0

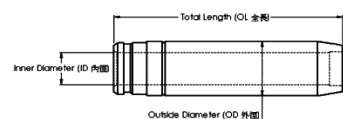

SIZE

STD

Gasket Set

OEM NO.



MITSUBISHI

8DC91N

Application : TRUCK BUS
Number of Cylinders 8
Cylinder dia. 135.0 MM
Swept Volume 16031 ccm

Piston kit-Set

OEM NO. ME090163

Piston	SIZE
Comp : 88.3 w/al-fin Height : -24.6 Length : 153.1 Shape : Ø73.2 Direct Injection Pin : 50.0 Length : 112.0	STD



Piston Ring

OEM NO. ME090758
NPR : SDM31-087ZZ

OEM Ring Groove	SIZE
Top : 3.3DK 2nd : 3.0 3rd : 3.0 Oil : 4.0	STD



Cylinder Liner

OEM NO. ME061782

Liner&Sleeve	SIZE
In Diameter : 135.0 Out Diameter : 155.0 Total length : 259.3 Flange : 163.0*11.8+1.7	STD



Engine Bearing

MAIN : 31209-70020
CON.ROD : 31219-32010
T/W : 31209-33100
C/B :
BUSH : 31219-34300

SIZE
STD



Engine Valve

OEM NO. ME061545
IN 59.0 12.0 174.7
OEM NO. ME061547
EX 53.0 12.0 175.0

SIZE
STD

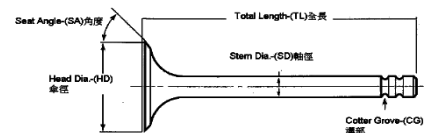

Valve Seat

OEM NO. 31201-30491
IN 61.0 52.0 7.3
OEM NO. 31201-30591
EX 55.0 46.0 7.3

SIZE
STD

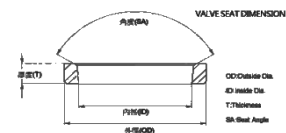

Valve Guide

OEM NO. 31101-00601
IN 83.0 12.0 20.0
OEM NO. 31201-30700
EX 93.5 12.0 20.0

SIZE
STD

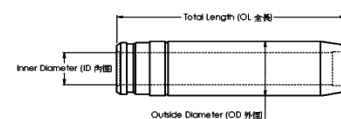

Gasket Set

OEM NO.



MITSUBISHI

8DC91T

Application : TRUCK BUS
 Number of Cylinders 8
 Cylinder dia. 135.0 MM
 Swept Volume 16031 ccm

Piston kit-Set

OEM NO. ME090166

Piston	SIZE
Comp : 88.3 w/al-fin Height : -25.7 Length : 153.1 Shape : Ø79.0 Direct Injection Pin : 50.0 Length : 112.0	STD



Piston Ring

OEM NO. ME090758
 NPR : SDM31-087ZZ

OEM Ring Groove	SIZE
Top : 3.3DK 2nd : 3.0 3rd : 3.0 Oil : 4.0	STD



Cylinder Liner

OEM NO. ME061782

Liner&Sleeve	SIZE
In Diameter : 135.0 Out Diameter : 155.0 Total length : 259.3 Flange : 163.0*11.8+1.7	STD



Engine Bearing

MAIN : 31209-70020
 CON.ROD : 31219-32010
 T/W : 31209-33100
 C/B :
 BUSH : 31219-34300

SIZE
 STD



Engine Valve

OEM NO. ME061545
 IN 59.0 12.0 174.7
 OEM NO. ME061547
 EX 53.0 12.0 175.0

SIZE
 STD

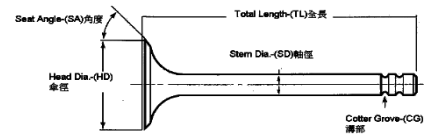

Valve Seat

OEM NO. 31201-30491
 IN 61.0 52.0 7.3
 OEM NO. 31201-30591
 EX 55.0 46.0 7.3

SIZE
 STD

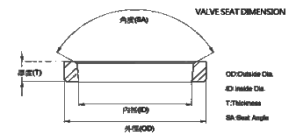

Valve Guide

OEM NO. 31101-00601
 IN 83.0 12.0 20.0
 OEM NO. 31201-30700
 EX 93.5 12.0 20.0

SIZE
 STD

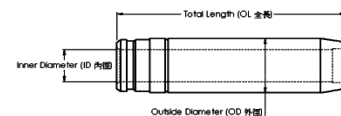

Gasket Set

OEM NO.



MITSUBISHI 8DC91TN-3V

Application : TRUCK BUS
Number of Cylinders 8
Cylinder dia. 135.0 MM
Swept Volume 16031 ccm

Piston kit-Set

OEM NO. ME090167

Piston	SIZE
Comp : 88.0 w/al-fin Height : -24.7 Length : 153.1 Shape : Ø73.5 Direct Injection Pin : 50.0 Length : 112.0	STD



Piston Ring

OEM NO. ME090758
NPR : SDM31-087ZZ

OEM Ring Groove	SIZE
Top : 3.3DK 2nd : 3.0 3rd : 3.0 Oil : 4.0	STD



Cylinder Liner

OEM NO. ME061782

Liner&Sleeve	SIZE
In Diameter : 135.0 Out Diameter : 155.0 Total length : 259.3 Flange : 163.0*11.8+1.7	STD



Engine Bearing

MAIN : 31209-70020
CON.ROD : 31219-32010
T/W : 31209-33100
C/B :
BUSH : 31219-34300

SIZE
STD



Engine Valve

OEM NO. ME061545
IN 59.0 12.0 174.7
OEM NO. ME061547
EX 53.0 12.0 175.0

SIZE
STD

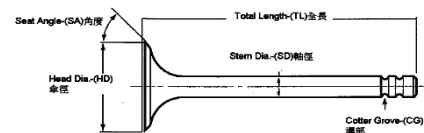

Valve Seat

OEM NO. 31201-30491
IN 61.0 52.0 7.3
OEM NO. 31201-30591
EX 55.0 46.0 7.3

SIZE
STD

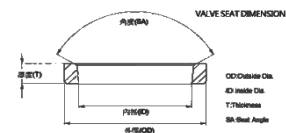

Valve Guide

OEM NO. 31101-00601
IN 83.0 12.0 20.0
OEM NO. 31201-30700
EX 93.5 12.0 20.0

SIZE
STD

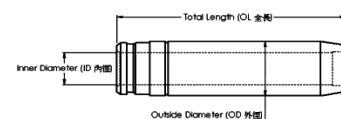

Gasket Set

OEM NO.



MITSUBISHI

8DC91T

Application : TRUCK BUS
Number of Cylinders 8
Cylinder dia. 135.0 MM
Swept Volume 16031 ccm

Piston kit-Set

OEM NO. ME091419

Piston

SIZE

Comp : 88.3 w/al-fin Height : -25.0 Length : 153.1
Shape : Ø77.4
Direct Injection
Pin : 50.0 Length : 112.0

STD



Piston Ring

OEM NO. ME090758
NPR : SDM31-087ZZ

OEM Ring Groove

SIZE

Top : 3.3DK
2nd : 3.0
3rd : 3.0
Oil : 4.0

STD



Cylinder Liner

OEM NO. ME061782

Liner&Sleeve

SIZE

In Diameter : 135.0
Out Diameter : 155.0
Total length : 259.3
Flange : 163.0*11.8+1.7

STD



Engine Bearing

MAIN : 31209-70020
CON.ROD : 31219-32010
T/W : 31209-33100
C/B :
BUSH : 31219-34300

SIZE

STD



Engine Valve

OEM NO. ME061545
IN 59.0 12.0 174.7
OEM NO. ME061547
EX 53.0 12.0 175.0

SIZE

STD

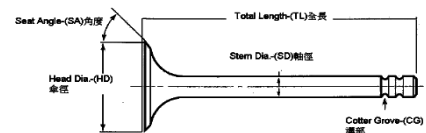

Valve Seat

OEM NO. 31201-30491
IN 61.0 52.0 7.3
OEM NO. 31201-30591
EX 55.0 46.0 7.3

SIZE

STD

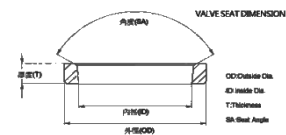

Valve Guide

OEM NO. 31101-00601
IN 83.0 12.0 20.0
OEM NO. 31201-30700
EX 93.5 12.0 20.0

SIZE

STD

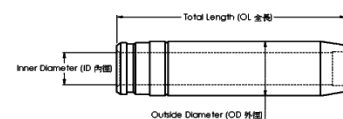

Gasket Set

OEM NO.



MITSUBISHI

8DC92A

Application : TRUCK BUS
Number of Cylinders 8
Cylinder dia. 135.0 MM
Swept Volume 16031 ccm

Piston kit-Set

OEM NO. ME091048



Piston

SIZE

Comp : 88.3 w/al-fin Height : -24.5 Length : 152.0
Shape : Ø73.0
Direct Injection
Pin : 50.0 Length : 112.0

STD

Piston Ring

OEM NO. ME090758
NPR : SDM31-087ZZ



OEM Ring Groove

SIZE

Top : 3.3DK
2nd : 3.0
3rd : 3.0
Oil : 4.0

STD

Cylinder Liner

OEM NO. ME061782



Liner&Sleeve

SIZE

In Diameter : 135.0
Out Diameter : 155.0
Total length : 259.3
Flange : 163.0*11.8+1.7

STD

Engine Bearing

MAIN : 31209-70020
CON.ROD : 31219-32010
T/W : 31209-33100
C/B :
BUSH : 31219-34300



SIZE

STD

Engine Valve

OEM NO. ME061545
IN 59.0 12.0 174.7
OEM NO. ME061547
EX 53.0 12.0 175.0

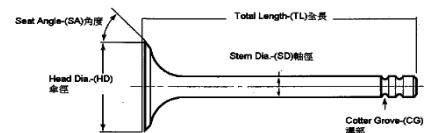

SIZE

STD

Valve Seat

OEM NO. 31201-30491
IN 61.0 52.0 7.3
OEM NO. 31201-30591
EX 55.0 46.0 7.3

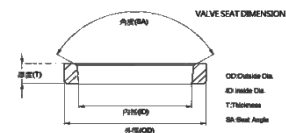

SIZE

STD

Valve Guide

OEM NO. 31101-00601
IN 83.0 12.0 20.0
OEM NO. 31201-30700
EX 93.5 12.0 20.0

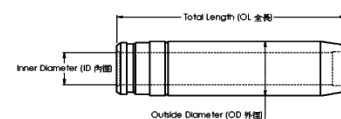

SIZE

STD

Gasket Set

OEM NO.



MITSUBISHI

8DC92T

Application : TRUCK BUS
Number of Cylinders 8
Cylinder dia. 135.0 MM
Swept Volume 16031 ccm

Piston kit-Set

OEM NO. ME091312

Piston

SIZE

Comp : 88.0 w/al-fin Height : -27.2 Length : 153.1
Shape : Ø79.0
Direct Injection
Pin : 50.0 Length : 112.0

STD

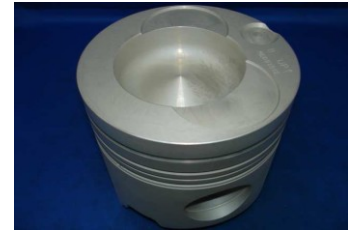

Piston Ring

OEM NO. ME090758
NPR : SDM31-087ZZ

OEM Ring Groove

SIZE

Top : 3.3DK
2nd : 3.0
3rd : 3.0
Oil : 4.0

STD



Cylinder Liner

OEM NO. ME061782

Liner&Sleeve

SIZE

In Diameter : 135.0
Out Diameter : 155.0
Total length : 259.3
Flange : 163.0*11.8+1.7

STD



Engine Bearing

MAIN : 31209-70020
CON.ROD : 31219-32010
T/W : 31209-33100
C/B :
BUSH : 31219-34300

SIZE

STD



Engine Valve

OEM NO. ME061545
IN 59.0 12.0 174.7
OEM NO. ME061547
EX 53.0 12.0 175.0

SIZE

STD

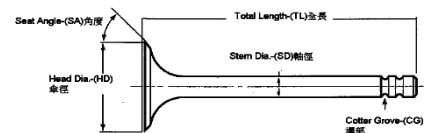

Valve Seat

OEM NO. 31201-30491
IN 61.0 52.0 7.3
OEM NO. 31201-30591
EX 55.0 46.0 7.3

SIZE

STD

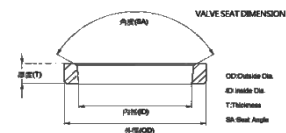

Valve Guide

OEM NO. 31101-00601
IN 83.0 12.0 20.0
OEM NO. 31201-30700
EX 93.5 12.0 20.0

SIZE

STD

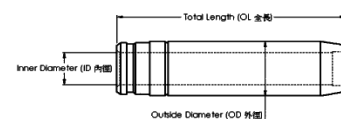

Gasket Set

OEM NO.



MITSUBISHI

8DC92T(3V)

Application : TRUCK BUS
Number of Cylinders 8
Cylinder dia. 135.0 MM
Swept Volume 16031 ccm

Piston kit-Set

OEM NO. ME093526



Piston	SIZE
Comp : 88.0 w/al-fin Height : -28.5 Length : 150.0 Shape : Ø61.0 Direct Injection Pin : 50.0 Length : 112.0	STD

Piston Ring

OEM NO. ME090758
 NPR : SDM31-087ZZ



OEM Ring Groove	SIZE
Top : 3.3DK 2nd : 3.0 3rd : 3.0 Oil : 4.0	STD

Cylinder Liner

OEM NO. ME061782



Liner&Sleeve	SIZE
In Diameter : 135.0 Out Diameter : 155.0 Total length : 259.3 Flange : 163.0*11.8+1.7	STD

Engine Bearing

MAIN : 31209-70020
 CON.ROD : 31219-32010
 T/W : 31209-33100
 C/B :
 BUSH : 31219-34300



	SIZE
	STD

Engine Valve

OEM NO. ME061545
 IN 59.0 12.0 174.7
 OEM NO. ME061547
 EX 53.0 12.0 175.0

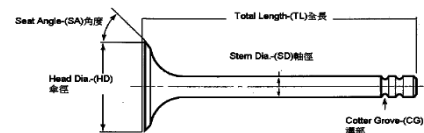

	SIZE
	STD

Valve Seat

OEM NO. 31201-30491
 IN 61.0 52.0 7.3
 OEM NO. 31201-30591
 EX 55.0 46.0 7.3

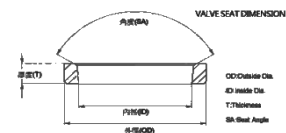

	SIZE
	STD

Valve Guide

OEM NO. 31101-00601
 IN 83.0 12.0 20.0
 OEM NO. 31201-30700
 EX 93.5 12.0 20.0

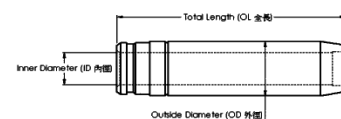

	SIZE
	STD

Gasket Set

OEM NO.



Piston kit-Set

OEM NO. ME093424

Piston	SIZE
Comp : 88.3 w/al-fin Height : -28.7 Length : 153.1 Shape : Ø61.0 Direct Injection Pin : 50.0 Length : 112.0	STD



Piston Ring

OEM NO. ME090758
NPR : SDM31-087ZZ

OEM Ring Groove	SIZE
Top : 3.3DK 2nd : 3.0 3rd : 3.0 Oil : 4.0	STD



Cylinder Liner

OEM NO. ME061782

Liner&Sleeve	SIZE
In Diameter : 135.0 Out Diameter : 155.0 Total length : 259.3 Flange : 163.0*11.8+1.7	STD



Engine Bearing

MAIN : 31209-70020
CON.ROD : 31219-32010
T/W : 31209-33100
C/B :
BUSH : 31219-34300

SIZE
STD



Engine Valve

OEM NO. ME061545
IN 59.0 12.0 174.7
OEM NO. ME061547
EX 53.0 12.0 175.0

SIZE
STD

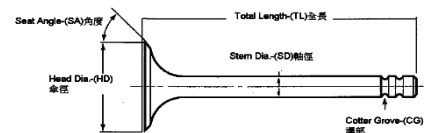

Valve Seat

OEM NO. 31201-30491
IN 61.0 52.0 7.3
OEM NO. 31201-30591
EX 55.0 46.0 7.3

SIZE
STD

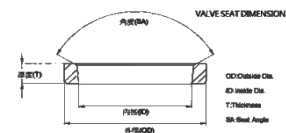

Valve Guide

OEM NO. 31101-00601
IN 83.0 12.0 20.0
OEM NO. 31201-30700
EX 93.5 12.0 20.0

SIZE
STD

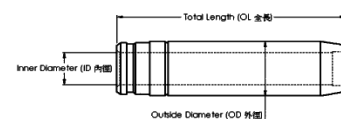

Gasket Set

OEM NO.



Piston kit-Set

OEM NO. ME160286

Piston

SIZE

Comp : 82.7 w/al-fin Height : -25.1 Length : 148.0
Shape : Ø76.8
Direct Injection
Pin : 50.0 Length : 112.0

STD



Piston Ring

OEM NO. ME996163
NPR : SDM31-138ZZ

OEM Ring Groove

SIZE

Top : 3.3DK
2nd : 3.0
3rd : 3.0
Oil : 4.0

STD



Cylinder Liner

OEM NO.

Liner&Sleeve

SIZE

In Diameter : 146.0
Out Diameter : 169.0
Total length : 257.0
Flange : 177.5*12.0+1.2

STD



Engine Bearing

MAIN : ME997681
CON.ROD : ME093763
T/W : ME160013
C/B :
BUSH :

SIZE

STD



Engine Valve

OEM NO. ME160062
IN 50.0 10.0 185.2
OEM NO. ME350711
EX 46.0 10.0 185.4

SIZE

STD

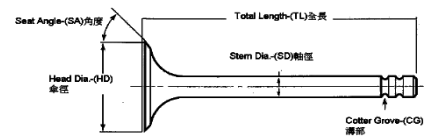

Valve Seat

OEM NO. ME160592
IN 53.0 43.3 7.0
OEM NO. ME165420
EX 49.0 39.7 7.0

SIZE

STD

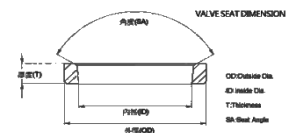

Valve Guide

OEM NO. ME-120085
IN 95.0 10.0 15.0
OEM NO. ME-120087
EX 95.0 10.0 15.0

SIZE

STD

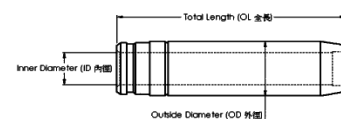

Gasket Set

OEM NO.



Piston kit-Set

OEM NO. ME161112

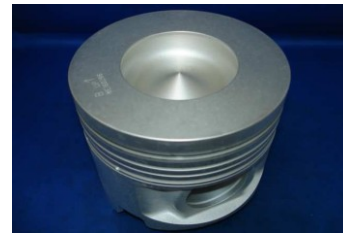

Piston

SIZE

Comp : 83.0 w/al-fin Height : -26.7 Length : 148.0
Shape : Ø96.0
Direct Injection
Pin : 50.0 Length : 112.0

STD

Piston Ring

OEM NO. ME996163
NPR : SDM31-138ZZ



OEM Ring Groove

SIZE

Top : 3.3DK
2nd : 3.0
3rd : 3.0
Oil : 4.0

STD

Cylinder Liner

OEM NO.



Liner&Sleeve

SIZE

In Diameter : 146.0
Out Diameter : 169.0
Total length : 257.0
Flange : 177.5*12.0+1.2

STD

Engine Bearing

MAIN : ME997681
CON.ROD : ME093763
T/W : ME160013
C/B :
BUSH :



SIZE

STD

Engine Valve

OEM NO. ME160062
IN 50.0 10.0 185.2
OEM NO. ME350711
EX 46.0 10.0 185.4

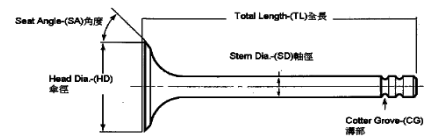

SIZE

STD

Valve Seat

OEM NO. ME160592
IN 53.0 43.3 7.0
OEM NO. ME165420
EX 49.0 39.7 7.0

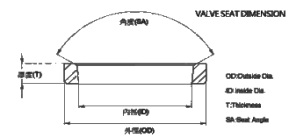

SIZE

STD

Valve Guide

OEM NO. ME-120085
IN 95.0 10.0 15.0
OEM NO. ME-120087
EX 95.0 10.0 15.0

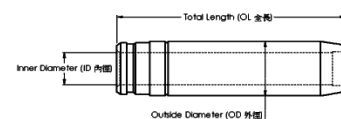

SIZE

STD

Gasket Set

OEM NO.



Piston kit-Set

OEM NO. ME161300

Piston

SIZE

 Comp : 82.7 w/al-fin Height : -26.3 oil-cooled Length : 148.0
 Shape : Ø71.5
 Direct Injection
 Pin : 50.0 Length : 112.0

STD

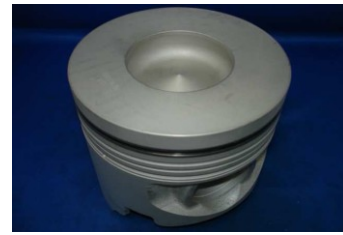

Piston Ring

OEM NO. ME996167

NPR :

OEM Ring Groove

SIZE

 Top : 3.3DK
 2nd : 3.0
 3rd : 3.0
 Oil : 4.0

STD



Cylinder Liner

OEM NO.

Liner&Sleeve

SIZE

 In Diameter : 150.0
 Out Diameter : 169.0
 Total length : 257.5
 Flange : 177.5*12.0+1.4

STD



Engine Bearing

 MAIN : ME997681
 CON.ROD : ME093763
 T/W : ME160013
 C/B :
 BUSH :

SIZE

STD



Engine Valve

 OEM NO. ME160062
 IN 50.0 10.0 185.2
 OEM NO. ME350711
 EX 46.0 10.0 185.4

SIZE

STD

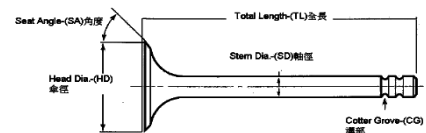

Valve Seat

 OEM NO. ME160592
 IN 53.0 43.3 7.0
 OEM NO. ME165420
 EX 49.0 39.7 7.0

SIZE

STD

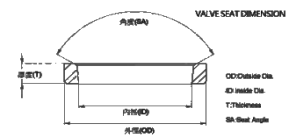

Valve Guide

 OEM NO. ME-120085
 IN 95.0 10.0 15.0
 OEM NO. ME-120087
 EX 95.0 10.0 15.0

SIZE

STD

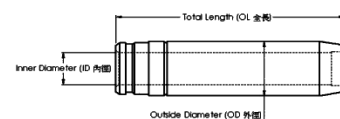

Gasket Set

OEM NO.



Piston kit-Set

OEM NO. ME163823

Piston

SIZE

Comp : 82.7 w/al-fin Height : -26.3 oil-cooled Length : 148.0
Shape : Ø71.6
Direct Injection
Pin : 50.0 Length : 112.0

STD



Piston Ring

OEM NO. ME996167

NPR :

OEM Ring Groove

SIZE

Top : 3.3DK
2nd : 3.0
3rd : 3.0
Oil : 4.0

STD



Cylinder Liner

OEM NO.

Liner&Sleeve

SIZE

In Diameter : 150.0
Out Diameter : 169.0
Total length : 257.5
Flange : 177.5*12.0+1.4

STD



Engine Bearing

MAIN : ME997681
CON.ROD : ME093763
T/W : ME160013
C/B :
BUSH :

SIZE

STD



Engine Valve

OEM NO. ME160062
IN 50.0 10.0 185.2
OEM NO. ME350711
EX 46.0 10.0 185.4

SIZE

STD

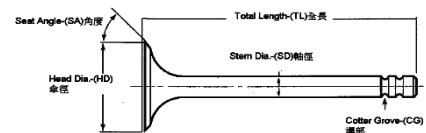

Valve Seat

OEM NO. ME160592
IN 53.0 43.3 7.0
OEM NO. ME165420
EX 49.0 39.7 7.0

SIZE

STD

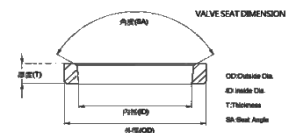

Valve Guide

OEM NO. ME-120085
IN 95.0 10.0 15.0
OEM NO. ME-120087
EX 95.0 10.0 15.0

SIZE

STD

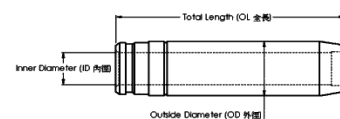

Gasket Set

OEM NO.



Piston kit-Set

OEM NO. ME163189

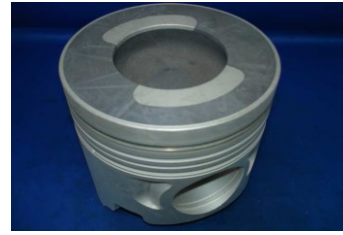

Piston

SIZE

Comp : 82.8 w/al-fin Height : -26.3 oil-cooled Length : 147.6
Shape : Ø73.0
Direct Injection Head Anodized
Pin : 55.0 Length : 116.0

STD

Piston Ring

OEM NO.
NPR :



OEM Ring Groove

SIZE

Top : 3.80DK
2nd : 3.0
3rd : 3.0
Oil : 4.0

STD

Cylinder Liner

OEM NO.



Liner&Sleeve

SIZE

In Diameter : 142.0
Out Diameter : 169.0
Total length : 257.0
Flange : 177.5*12.0+1.2

STD

Engine Bearing

MAIN : ME997681
CON.ROD : ME093763
T/W : ME160013
C/B :
BUSH :



SIZE

STD

Engine Valve

OEM NO. ME160062
IN 50.0 10.0 185.2
OEM NO. ME350711
EX 46.0 10.0 185.4

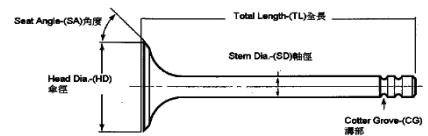

SIZE

STD

Valve Seat

OEM NO. ME160592
IN 53.0 43.3 7.0
OEM NO. ME165420
EX 49.0 39.7 7.0

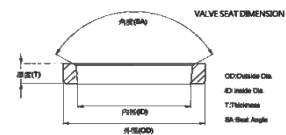

SIZE

STD

Valve Guide

OEM NO. ME-120085
IN 95.0 10.0 15.0
OEM NO. ME-120087
EX 95.0 10.0 15.0

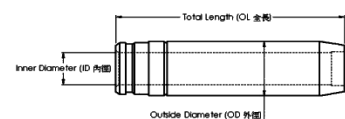

SIZE

STD

Gasket Set

OEM NO.



Piston kit-Set

OEM NO. 32517-60200

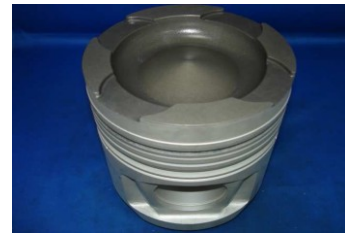

Piston

SIZE

Comp : 99.5 w/al-fin Height : -21.2 oil-cooled Length : 161.7
Shape : Ø105.0
Direct Injection Head Anodized
Pin : 55.0 Length : 111.5

STD

Piston Ring

OEM NO.

NPR : SJM30-107ZZ



OEM Ring Groove

SIZE

Top : 4.4DK
2nd : 2.92
3rd : 6.0
Oil :

STD

Cylinder Liner

OEM NO. 32507-12100



Liner&Sleeve

SIZE

In Diameter : 145.0
Out Diameter :
Total length : 301.0
Flange : 165.5*12.0

STD

Engine Bearing

MAIN : 32509-20010

CON.ROD : 31519-42100

T/W :

C/B :

BUSH :



SIZE

STD

Engine Valve

OEM NO.

IN 50.0 10.0 180.0

OEM NO. ME350711

EX 44.0 10.0 180.0

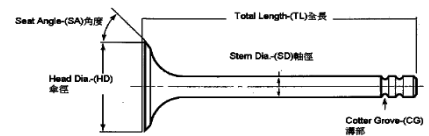

SIZE

STD

Valve Seat

OEM NO.

IN

OEM NO.

EX

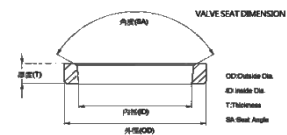

SIZE

STD

Valve Guide

OEM NO. 37101-00600

IN/EX 100.0 10.0 18.0

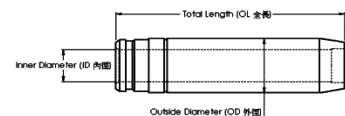

SIZE

STD

Gasket Set

OEM NO.



Piston kit-Set

OEM NO. 32517-60200/32517-50400

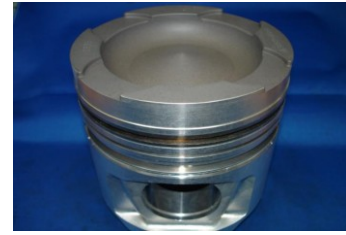

Piston

SIZE

Comp : 99.5 w/al-fin Height : -21.2 oil-cooled Length : 161.7
 Shape : Ø105.0
 Direct Injection Head Anodized
 Pin : 55.0 Length : 111.5

STD

Piston Ring

OEM NO.

NPR : SJM30-107ZZ



OEM Ring Groove

SIZE

Top : 4.4HK
 2nd : 2.92
 3rd : 6.0
 Oil :

STD

Cylinder Liner

OEM NO. 32507-12100



Liner&Sleeve

SIZE

In Diameter : 145.0
 Out Diameter :
 Total length : 301.0
 Flange : 165.5*12.0

STD

Engine Bearing

MAIN : 32509-20010

CON.ROD : 31519-42100

T/W :

C/B :

BUSH :

SIZE



STD

Engine Valve

OEM NO.

IN 50.0 10.0 180.0

OEM NO. ME350711

EX 44.0 10.0 180.0

SIZE

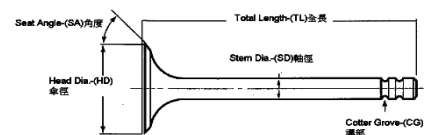

STD

Valve Seat

OEM NO.

IN

OEM NO.

EX

SIZE

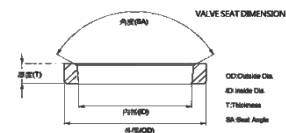

STD

Valve Guide

OEM NO. 37101-00600

IN/EX 100.0 10.0 18.0

SIZE

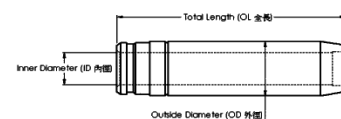

STD

Gasket Set

OEM NO.



Piston kit-Set

OEM NO. 32517-60400

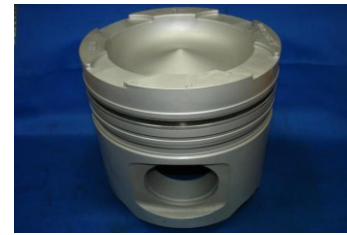

Piston

SIZE

Comp : 99.9 w/al-fin Height : -25.0 oil-cooled Length : 161.6
Shape : Ø105.0
Direct Injection
Pin : 55.0 Length : 111.5

STD

Piston Ring

OEM NO.

NPR : SJM30-107ZZ



OEM Ring Groove

SIZE

Top : 4.4HK
2nd : 2.92DK
3rd : 6.0
Oil :

STD

Cylinder Liner

OEM NO. 32507-12100



Liner&Sleeve

SIZE

In Diameter : 145.0
Out Diameter :
Total length : 301.0
Flange : 165.5*12.0

STD

Engine Bearing

MAIN : 32509-20010

CON.ROD : 31519-42100

T/W :

C/B :

BUSH :



SIZE

STD

Engine Valve

OEM NO.

IN 50.0 10.0 180.0

OEM NO. ME350711

EX 44.0 10.0 180.0

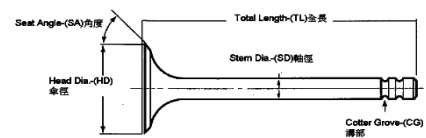

SIZE

STD

Valve Seat

OEM NO.

IN

OEM NO.

EX

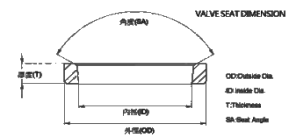

SIZE

STD

Valve Guide

OEM NO. 37101-00600

IN/EX 100.0 10.0 18.0

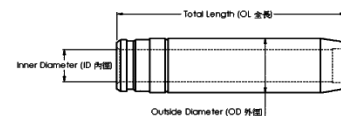

SIZE

STD

Gasket Set

OEM NO.



Piston kit-Set

OEM NO. 32517-91100

Piston	SIZE
Comp : 99.7 w/al-fin Height : -21.8 oil-cooled Length : 161.6 Shape : Ø110.0 Direct Injection Pin : 58.0 Length : 124.0	STD



Piston Ring

OEM NO. 32517-17010
 NPR : SJM30-109ZZ

OEM Ring Groove	SIZE
Top : 4.4K 2nd : 2.92 Oil : 6.0	STD



Cylinder Liner

OEM NO. 32507-22400

Liner&Sleeve	SIZE
In Diameter : 150.0 Out Diameter : 171.5 Total length : 300.5 Flange : 181.0*12.0+1.5	STD



Engine Bearing

MAIN :	SIZE
CON.ROD :	STD
T/W :	
C/B :	
BUSH :	



Engine Valve

OEM NO. 32504-00200	SIZE
IN 54.0 10.0 180.0 60 2R	STD
OEM NO. 32504-01200	
EX 50.0 10.0 180.0 60 2R	

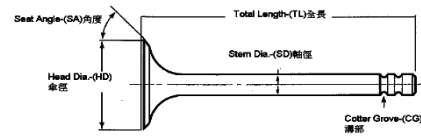

Valve Seat

OEM NO. 33701-10400	SIZE
IN 58.0 46.0 8.6	STD
OEM NO. 33701-10500	
EX 54.0 43.8 8.5	

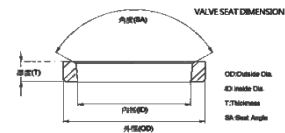

Valve Guide

OEM NO. 32501-10700	SIZE
IN/EX 85.0 10.0 18.0	STD

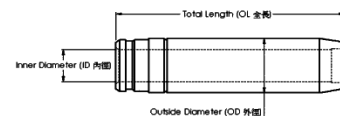

Gasket Set

OEM NO.



Piston kit-Set

OEM NO. 32A17-30101

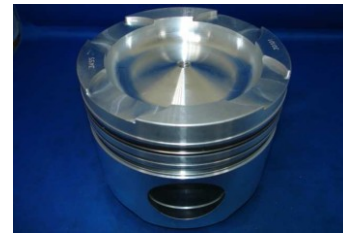

Piston

SIZE

Comp : 90.15 w/al-fin Height : -21.9 oil-cooled Length : 154.0
 Shape : Ø110.0
 Direct Injection
 Pin : 58.0 Length : 124.0

STD

Piston Ring

OEM NO.

NPR :

OEM Ring Groove

SIZE

Top : 3.4K
 2nd : 2.5
 Oil : 6.0

STD



Cylinder Liner

OEM NO. 32A07-1300

Liner&Sleeve

SIZE

In Diameter : 150.0
 Out Diameter : 171.5
 Total length : 300.5
 Flange : 181.0*12.0+1.5

STD



Engine Bearing

MAIN :

CON.ROD :

T/W :

C/B :

BUSH :

SIZE

STD



Engine Valve

OEM NO. 32504-00200

IN 54.0 10.0 180.0 60 2R

OEM NO. 32504-01200

EX 50.0 10.0 180.0 60 2R

SIZE

STD

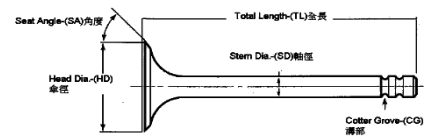

Valve Seat

OEM NO. 33701-10400

IN 58.0 46.0 8.6

OEM NO. 33701-10500

EX 54.0 43.8 8.5

SIZE

STD

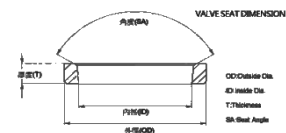

Valve Guide

OEM NO. 32501-10700

IN/EX 85.0 10.0 18.0

SIZE

STD

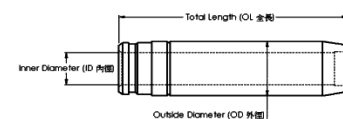

Gasket Set

OEM NO.



Piston kit-Set

OEM NO. 36217-30700

Piston	SIZE
Comp : 88.0 Height : -19.0 Length : 152.8 Shape : Ø95.0 Direct Injection Pin : 50.0 Length :	STD



Piston Ring

OEM NO. 36217-17010
NPR : XDM30-106ZZ

OEM Ring Groove	SIZE
Top : 4.0K 2nd : 3.0 Oil : 6.0	STD



Cylinder Liner

OEM NO. 36207-12100

Liner&Sleeve	SIZE
In Diameter : 135.0 Out Diameter : 154.0 Total length : 268.0 Flange : 163.0*12.0+1.0	STD



Engine Bearing

MAIN : 36209-40010
CON.ROD : 36219-12100
T/W :
C/B :
BUSH :

SIZE
STD



Engine Valve

OEM NO. 36204-20100
IN 48.0 10.0 180.0 60 2R
OEM NO. 36204-41101
EX 44.0 10.0 180.0 60 2R

SIZE
STD

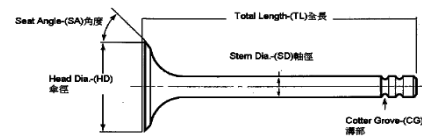

Valve Seat

OEM NO. 34A01-30400
IN 50.0 43.9 9.2
OEM NO. 36201-20100
EX 46.0 40.5 9.2

SIZE
STD

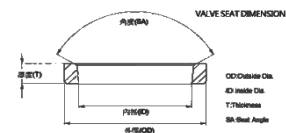

Valve Guide

OEM NO. 32501-10700
IN/EX 85.0 10.0 18.0

SIZE
STD

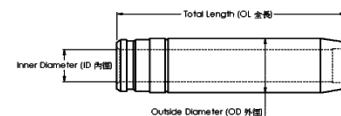

Gasket Set

OEM NO.



Piston kit-Set

OEM NO. 36217-30100

Piston

SIZE

Comp : Height : Length :
Shape : Ø94.8
Direct Injection Head Anodized
Pin : 50.0 Length :

STD

Piston Ring

OEM NO.

NPR :

OEM Ring Groove

SIZE

Top :
2nd :
Oil :

STD



Cylinder Liner

OEM NO. 32207-12100

Liner&Sleeve

SIZE

In Diameter : 135.0
Out Diameter : 154.0
Total length : 268.0
Flange : 163.0*12.0+1.0

STD



Engine Bearing

MAIN : 36209-40010
CON.ROD : 36219-12100
T/W :
C/B :
BUSH :

SIZE

STD



Engine Valve

OEM NO. 36204-20100
IN 48.0 10.0 180.0 60 2R
OEM NO. 36204-41101
EX 44.0 10.0 180.0 60 2R

SIZE

STD

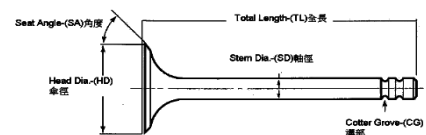

Valve Seat

OEM NO. 34A01-30400
IN 50.0 43.9 9.2
OEM NO. 36201-20100
EX 46.0 40.5 9.2

SIZE

STD

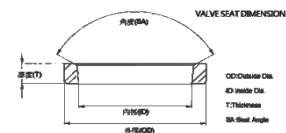

Valve Guide

OEM NO. 32501-10700
IN/EX 85.0 10.0 18.0

SIZE

STD

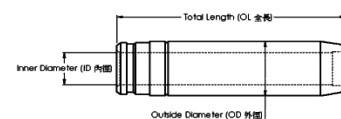

Gasket Set

OEM NO.



Piston kit-Set

OEM NO. 36217-67100

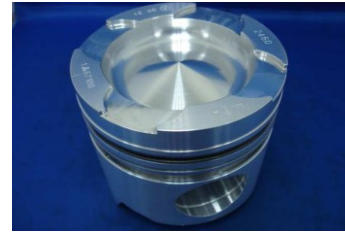

Piston

SIZE

Comp : 87.9 w/al-fin Height : -22.6 oil-cooled Length : 152.85
Shape : Ø95.0
Direct Injection
Pin : 55.0 Length : 111.5

STD

Piston Ring

OEM NO.

NPR :

OEM Ring Groove

SIZE

Top : 4.0DK
2nd : 3.0
Oil : 6.0

STD



Cylinder Liner

OEM NO. 36207-12100

Liner&Sleeve

SIZE

In Diameter : 135.0
Out Diameter : 154.0
Total length : 268.0
Flange : 163.0*12.0+1.0

STD



Engine Bearing

MAIN :
CON.ROD :
T/W :
C/B :
BUSH :

SIZE

STD



Engine Valve

OEM NO. 36204-20100
IN 48.0 10.0 180.0 60 2R
OEM NO. 36204-41101
EX 44.0 10.0 180.0 60 2R

SIZE

STD

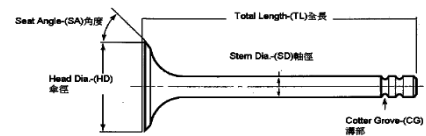

Valve Seat

OEM NO. 34A01-30400
IN 50.0 43.9 9.2
OEM NO. 36201-20100
EX 46.0 40.5 9.2

SIZE

STD

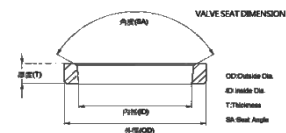

Valve Guide

OEM NO. 32501-10700
IN/EX 85.0 10.0 18.0

SIZE

STD

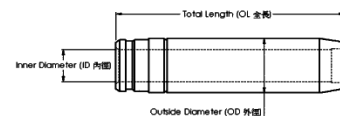

Gasket Set

OEM NO.



Piston kit-Set

OEM NO. 36217-61100/36217-70700



Piston

SIZE

Comp : 87.85 w/al-fin Height : -20.5 Length : 152.7
 Shape : Ø95.0
 Direct Injection
 Pin : 55.0 Length : 111.5

STD

Piston Ring

OEM NO. 36217-17010
 NPR : SDM30-106ZZ



OEM Ring Groove

SIZE

Top : 4.0K
 2nd : 3.0
 Oil : 6.0

STD

Cylinder Liner

OEM NO. 36207-12100



Liner&Sleeve

SIZE

In Diameter : 135.0
 Out Diameter : 154.0
 Total length : 268.0
 Flange : 163.0*12.0+1.0

STD

Engine Bearing

MAIN : 36209-40010
 CON.ROD : 36219-12100
 T/W :
 C/B :
 BUSH :



SIZE

STD

Engine Valve

OEM NO. 36204-20100
 IN 48.0 10.0 180.0 60 2R
 OEM NO. 36204-41101
 EX 44.0 10.0 180.0 60 2R

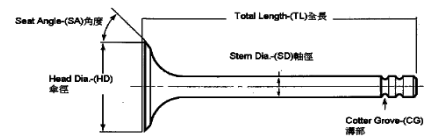

SIZE

STD

Valve Seat

OEM NO. 34A01-30400
 IN 50.0 43.9 9.2
 OEM NO. 36201-20100
 EX 46.0 40.5 9.2

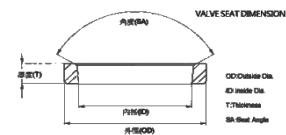

SIZE

STD

Valve Guide

OEM NO. 32501-10700
 IN/EX 85.0 10.0 18.0

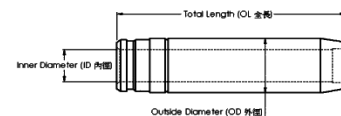

SIZE

STD

Gasket Set

OEM NO.



Piston kit-Set

OEM NO. 34A17-00201

Piston	SIZE
Comp : 129.8 w/al-fin Height : -22.7 oil-cooled Length : 144.8 Shape : Ø95.0 Direct Injection Pin : 55.0 Length : 111.5	STD

Piston Ring

OEM Ring Groove	SIZE
Top : 2nd : Oil :	STD



Cylinder Liner

Liner&Sleeve	SIZE
In Diameter : 135.0 Out Diameter : Total length : 272.7 Flange : 163.0*13.0+1.5	STD



Engine Bearing

	SIZE
MAIN : CON.ROD : T/W : C/B : BUSH :	STD



Engine Valve

	SIZE
OEM NO. IN OEM NO. EX	STD

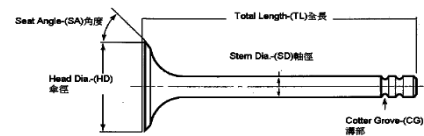

Valve Seat

	SIZE
OEM NO. IN OEM NO. EX	STD

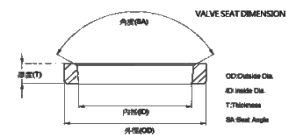

Valve Guide

	SIZE
OEM NO. IN OEM NO. EX	STD

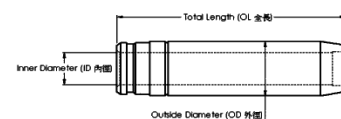

Gasket Set

OEM NO.	
---------	--



Piston kit-Set

OEM NO. 37117-44100

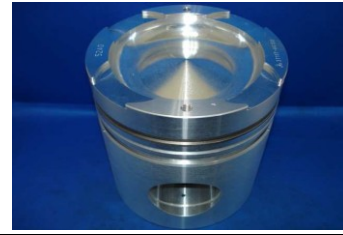

Piston

SIZE

Comp : 120.0 w/al-fin Height : -24.6 Length : 185.0
Shape : Ø122.0
Direct Injection
Pin : 65.0 Length : 133.0

STD

Piston Ring

OEM NO.
NPR :



OEM Ring Groove

SIZE

Top : 4.0DK
2nd : 4.0
Oil : 6.0

STD

Cylinder Liner

OEM NO. 37107-12100



Liner&Sleeve

SIZE

In Diameter : 160.0
Out Diameter : 180.0
Total length : 350.0
Flange : 190.0*12.2+1.5

STD

Engine Bearing

MAIN :
CON.ROD :
T/W :
C/B :
BUSH :



SIZE

STD

Engine Valve

OEM NO. 37104-01500
IN 54.0 10.0 196.5
OEM NO. 37104-20100
EX 50.0 10.0 197.3

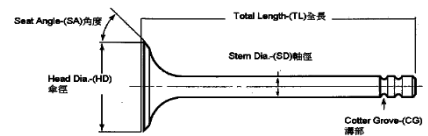

SIZE

STD

Valve Seat

OEM NO. 33501-00400
IN 58.0 48.0 9.0
OEM NO. 33501-00500
EX 54.0 44.0 9.0

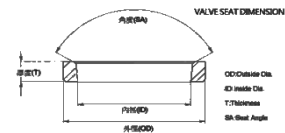

SIZE

STD

Valve Guide

OEM NO. 37101-00600
IN/EX 100.0 10.0 18.0

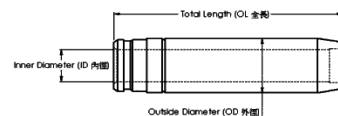

SIZE

STD

Gasket Set

OEM NO.



Piston kit-Set

OEM NO. 37117-26100

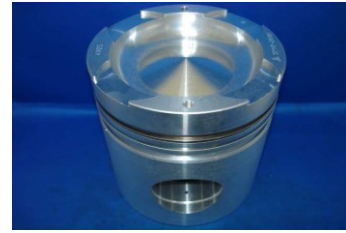

Piston	SIZE
Comp : 120.0 w/al-fin Height : -25.3 Length : 185.0 Shape : Ø120.0 Direct Injection Pin : 65.0 Length : 133.0	STD

Piston Ring

OEM NO.
NPR :



OEM Ring Groove	SIZE
Top : 4.5 2nd : 3.5 Oil : 6.0	STD

Cylinder Liner

OEM NO. 37107-12100



Liner&Sleeve	SIZE
In Diameter : 160.0 Out Diameter : 180.0 Total length : 350.0 Flange : 190.0*12.2+1.5	STD

Engine Bearing

MAIN :
CON.ROD :
T/W :
C/B :
BUSH :



	SIZE
	STD

Engine Valve

OEM NO. 37104-01500
IN 54.0 10.0 196.5
OEM NO. 37104-20100
EX 50.0 10.0 197.3

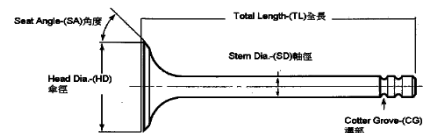

	SIZE
	STD

Valve Seat

OEM NO. 33501-00400
IN 58.0 48.0 9.0
OEM NO. 33501-00500
EX 54.0 44.0 9.0

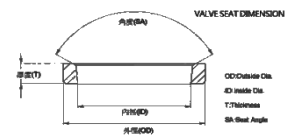

	SIZE
	STD

Valve Guide

OEM NO. 37101-00600
IN/EX 100.0 10.0 18.0

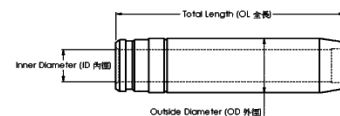

	SIZE
	STD

Gasket Set

OEM NO.



Piston kit-Set

OEM NO.

Piston

SIZE

Comp : 51.3 Height : -3.0 Length : 85.5
 Top Shape : Flower
 Pin : 25.0
 Length : 70.0

STD

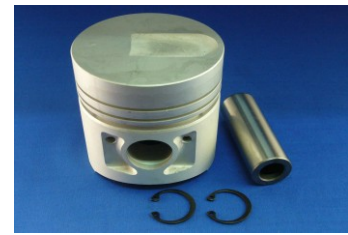

Piston Ring

OEM NO.

NPR :

OEM Ring Groove

SIZE

Top : 2.0
 2nd : 2.0
 Oil : 4.0

STD



Cylinder Liner

OEM NO.

Liner&Sleeve

SIZE

In Diameter :
 Out Diameter :
 Total length :
 Flange :

STD



Engine Bearing

MAIN :
 CON.ROD :
 T/W :
 C/B :
 BUSH :

SIZE

STD



Engine Valve

OEM NO.
 IN 35.3 8.0 133.0
 OEM NO.
 EX 26.0 8.0 133.0

SIZE

STD

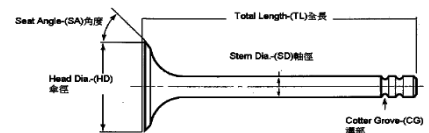

Valve Seat

OEM NO.
 IN
 OEM NO.
 EX

SIZE

STD

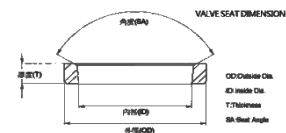

Valve Guide

OEM NO.
 IN
 OEM NO.
 EX

SIZE

STD

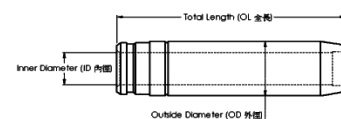

Gasket Set

OEM NO.



Piston kit-Set

OEM NO. 31A17-07100

Piston	SIZE
Comp : 39.85 Height : -2.7 Length : 72.6 Top Shape : Flower Pin : 23.0 Length : 63.0	STD 0.50



Piston Ring

OEM NO. MM433-921

NPR :

OEM Ring Groove	SIZE
Top : 2.5K 2nd : 2.0 Oil : 4.0	STD 0.50



Cylinder Liner

OEM NO.

Liner&Sleeve	SIZE
In Diameter : Out Diameter : Total length : Flange :	STD



Engine Bearing

MAIN : MM437-880
 CON.ROD : MM437-305
 T/W :
 C/B :
 BUSH :

SIZE
 STD



Engine Valve

OEM NO. MD016460
 IN 34.0 6.6 102.0
 OEM NO.
 EX 27.2 6.6 102.4

SIZE
 STD

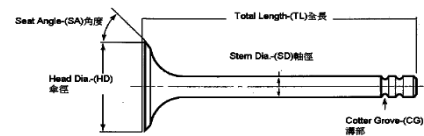

Valve Seat

OEM NO.
 IN
 OEM NO.
 EX

SIZE
 STD

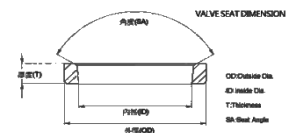

Valve Guide

OEM NO.
 IN
 OEM NO.
 EX

SIZE
 STD

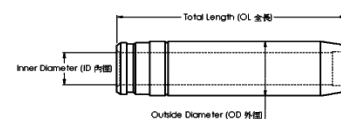

Gasket Set

OEM NO.



Piston kit-Set

OEM NO. 34417-20101



Piston	SIZE
Comp : 51.5 Height : -3.0 Length : 90.0 Top Shape : Flower Pin : 28.0 Length : 77.0	STD 0.50

Piston Ring

OEM NO.34417-11011

NPR :



OEM Ring Groove	SIZE
Top : 2.5K 2nd : 2.0 Oil : 4.5	STD 0.50

Cylinder Liner

OEM NO.



Liner&Sleeve	SIZE
In Diameter : 94.0 Out Diameter : 98.0 Total length : 168.0 Flange :	STD

Engine Bearing

MAIN : 34409-00100
CON.ROD : 34419-02100
T/W : 34409-08100
C/B :
BUSH :



	SIZE
	STD

Engine Valve

OEM NO. 34404-10100
IN 42.0 8.0 133.0 60°
OEM NO. 34404-11100
EX 35.0 8.0 133.0 60°

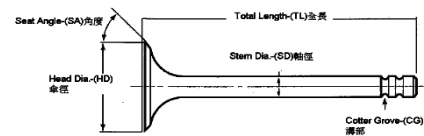

	SIZE
	STD

Valve Seat

OEM NO. 34401-21400
IN 44.0 37.0 6.0
OEM NO. 34401-21500
EX 37.0 30.5 6.0

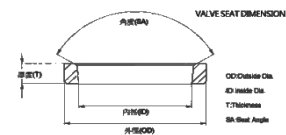

	SIZE
	STD

Valve Guide

OEM NO. 30601-20600
IN/EX 56.0 8.0 13.0

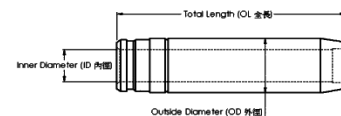

	SIZE
	STD

Gasket Set

OEM NO.



Piston kit-Set

OEM NO.

Piston

SIZE

Comp : 51.6 Height : -3.5 Length : 91.1
Top Shape : Flower
Pin : 28.0
Length : 77.0

STD
0.50



Piston Ring

OEM NO.34417-09012
NPR :

OEM Ring Groove

SIZE

Top : 3.0
2nd : 2.0
Oil : 5.0

STD
0.50



Cylinder Liner

OEM NO.

Liner&Sleeve

SIZE

In Diameter :
Out Diameter :
Total length :
Flange :

STD



Engine Bearing

MAIN : 34409-00100
CON.ROD : 34419-02100
T/W : 34409-08100
C/B :
BUSH :

SIZE

STD



Engine Valve

OEM NO.34404-00100
IN 42.0 8.0 133.0 45°
OEM NO.30604-01100
EX 35.0 8.0 133.0 45°

SIZE

STD

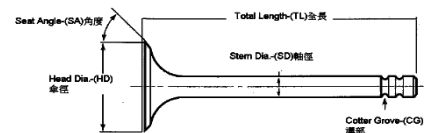

Valve Seat

OEM NO. 34401-21400
IN 44.0 37.0 6.0
OEM NO. 34401-21500
EX 37.0 30.5 6.0

SIZE

STD

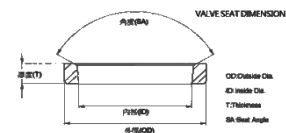

Valve Guide

OEM NO. 30601-20600
IN/EX 56.0 8.0 13.0

SIZE

STD

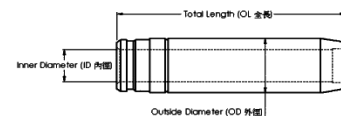

Gasket Set

OEM NO.



Piston kit-Set

OEM NO.

Piston	SIZE
Comp : 51.5 Height : -3.5 Length : 98.5 MOS2 Top Shape : Flower Pin : 28.0 Length : 77.0	STD 0.50

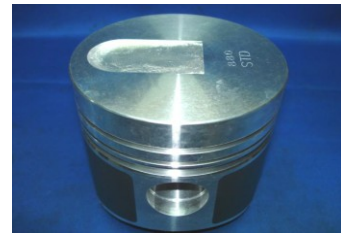

Piston Ring

OEM NO.34417-09012
NPR :

OEM Ring Groove	SIZE
Top : 3.0HK 2nd : 2.0 Oil : 5.0	STD 0.50



Cylinder Liner

OEM NO.

Liner&Sleeve	SIZE
In Diameter : Out Diameter : Total length : Flange :	STD



Engine Bearing

MAIN : 34409-00100
CON.ROD : 34419-02100
T/W : 34409-08100
C/B :
BUSH :

SIZE
STD



Engine Valve

OEM NO.34404-00100
IN 42.0 8.0 133.0 45°
OEM NO.30604-01100
EX 35.0 8.0 133.0 45°

SIZE
STD

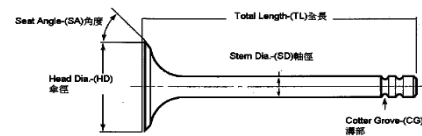

Valve Seat

OEM NO. 34401-21400
IN 44.0 37.0 6.0
OEM NO. 34401-21500
EX 37.0 30.5 6.0

SIZE
STD

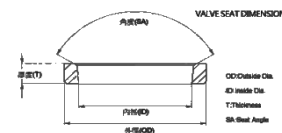

Valve Guide

OEM NO. 30601-20600
IN/EX 56.0 8.0 13.0

SIZE
STD

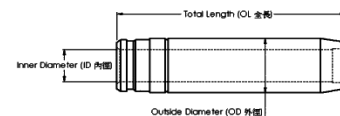

Gasket Set

OEM NO.



Piston kit-Set

OEM NO.

Piston

SIZE

Comp : 57.6 w/al-fin Height : -17.5 Length : 96.5
Top Shape : Ø50.0
Direct Injection
Pin : 28.0 Length : 77.0

STD
0.50



Piston Ring

OEM NO.34417-09012
NPR :

OEM Ring Groove

SIZE

Top : 3.0
2nd : 2.0
Oil : 5.0

STD
0.50



Cylinder Liner

OEM NO.

Liner&Sleeve

SIZE

In Diameter :
Out Diameter :
Total length :
Flange :

STD



Engine Bearing

MAIN : 34409-00100
CON.ROD : 34419-02100
T/W : 34409-08100
C/B :
BUSH :

SIZE

STD



Engine Valve

OEM NO.36704-00401
IN 44.0 8.0 133.0
OEM NO.36704-01501
EX 37.0 8.0 133.0

SIZE

STD

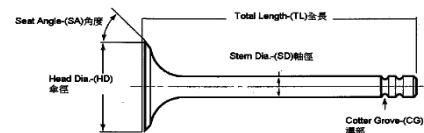

Valve Seat

OEM NO.
IN
OEM NO.
EX

SIZE

STD

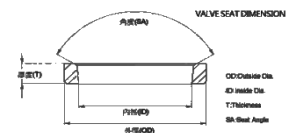

Valve Guide

OEM NO.
IN
OEM NO.
EX

SIZE

STD

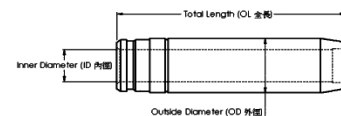

Gasket Set

OEM NO.



Piston kit-Set

OEM NO.

Piston

SIZE

Comp : 39.85 Height : -2.7 Length : 72.6
Top Shape : Flower
Pin : 23.0
Length : 63.0

STD
0.50



Piston Ring

OEM NO.MM433-921

NPR :

OEM Ring Groove

SIZE

Top : 2.5K
2nd : 2.0
Oil : 4.0

STD
0.50



Cylinder Liner

OEM NO.

Liner&Sleeve

SIZE

In Diameter :
Out Diameter :
Total length :
Flange :

STD



Engine Bearing

MAIN : MM437-880
CON.ROD : MM437-305
T/W :
C/B :
BUSH :

SIZE

STD



Engine Valve

OEM NO. MD016460
IN 34.0 6.6 102.0
OEM NO.
EX 27.2 6.6 102.4

SIZE

STD

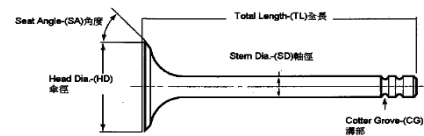

Valve Seat

OEM NO.
IN
OEM NO.
EX

SIZE

STD

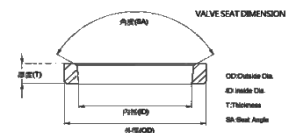

Valve Guide

OEM NO.
IN
OEM NO.
EX

SIZE

STD

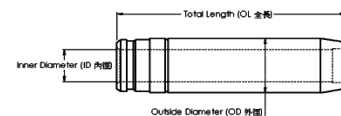

Gasket Set

OEM NO.



Piston kit-Set

OEM NO.

Piston

SIZE

Comp : Height : Length :
Top Shape :
Pin :
Length :

STD

Piston Ring

OEM NO.

NPR :

OEM Ring Groove

SIZE

Top :
2nd :
Oil :

STD



Cylinder Liner

OEM NO.

Liner&Sleeve

SIZE

In Diameter :
Out Diameter :
Total length :
Flange :

STD



Engine Bearing

MAIN :
CON.ROD :
T/W :
C/B :
BUSH :

SIZE

STD



Engine Valve

OEM NO.
IN
OEM NO.
EX

SIZE

STD

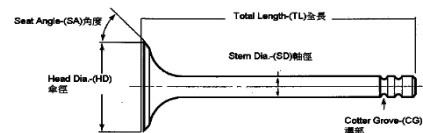

Valve Seat

OEM NO.
IN
OEM NO.
EX

SIZE

STD

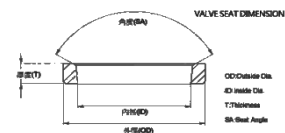

Valve Guide

OEM NO.
IN
OEM NO.
EX

SIZE

STD

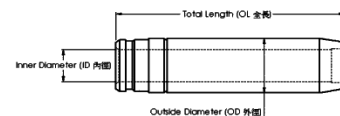

Gasket Set

OEM NO.



MITSUBISHI S4L2-T

Application :
Number of Cylinders 4
Cylinder dia. 78.0 MM
Swept Volume 1758 ccm

Piston kit-Set

OEM NO.

Piston

SIZE

Comp : Height : Length :
 Top Shape :
 Pin :
 Length :

STD

Piston Ring

OEM NO.

NPR :

OEM Ring Groove

SIZE

Top :
 2nd :
 Oil :

STD



Cylinder Liner

OEM NO.

Liner&Sleeve

SIZE

In Diameter :
 Out Diameter :
 Total length :
 Flange :

STD



Engine Bearing

MAIN :
 CON.ROD :
 T/W :
 C/B :
 BUSH :

SIZE

STD



Engine Valve

OEM NO.
 IN
 OEM NO.
 EX

SIZE

STD

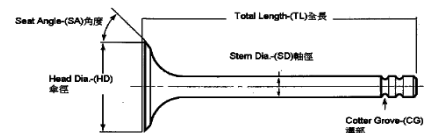

Valve Seat

OEM NO.
 IN
 OEM NO.
 EX

SIZE

STD

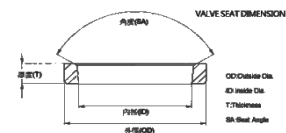

Valve Guide

OEM NO.
 IN
 OEM NO.
 EX

SIZE

STD

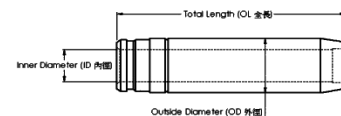

Gasket Set

OEM NO.



Piston kit-Set

OEM NO. 32C17-05100

Piston	SIZE
Comp : 51.0 Height : -3.8 Length : 86.3 Top Shape : Flower Pin : 28.0 Length : 72.0	STD

Piston Ring

OEM NO.30617-70011

NPR :

OEM Ring Groove	SIZE
Top : 2.5K 2nd : 2.0 Oil : 4.0	STD



Cylinder Liner

OEM NO.

Liner&Sleeve	SIZE
In Diameter : Out Diameter : Total length : Flange :	STD



Engine Bearing

MAIN : 32C09-02010
CON.ROD : 32A19-02010
T/W :
C/B :
BUSH :

SIZE
STD



Engine Valve

OEM NO. 32C04-10100
IN 40.0 8.0 117.7 60°
OEM NO. 32C04-11100
EX 31.0 8.0 117.7 60°

SIZE
STD

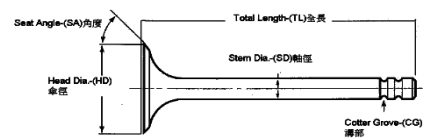

Valve Seat

OEM NO.
IN
OEM NO.
EX

SIZE
STD

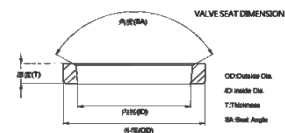

Valve Guide

OEM NO.
IN
OEM NO.
EX

SIZE
STD

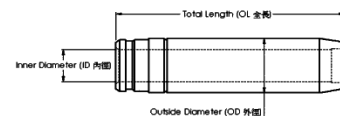

Gasket Set

OEM NO.



Piston kit-Set

OEM NO. 32C17-00100



Piston	SIZE
Comp : 51.0 Height : -3.8 Length : 86.0 Top Shape : Flower Pin : 28.0 Length : 72.0	STD

Piston Ring

OEM NO.30617-70011/30617-70010
NPR :



OEM Ring Groove	SIZE
Top : 2.5K 2nd : 2.0 Oil : 4.0	STD

Cylinder Liner

OEM NO.



Liner&Sleeve	SIZE
In Diameter : Out Diameter : Total length : Flange :	STD

Engine Bearing

MAIN : 32C09-02010
CON.ROD : 32A19-02010
T/W :
C/B :
BUSH :



	SIZE
	STD

Engine Valve

OEM NO. 32C04-10100
IN 40.0 8.0 117.7 60°
OEM NO. 32C04-11100
EX 31.0 8.0 117.7 60°

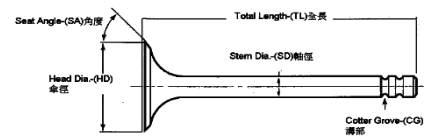

	SIZE
	STD

Valve Seat

OEM NO.
IN
OEM NO.
EX

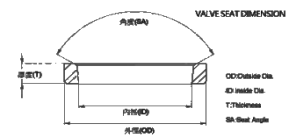

	SIZE
	STD

Valve Guide

OEM NO.
IN
OEM NO.
EX

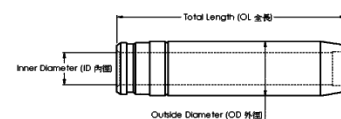

	SIZE
	STD

Gasket Set

OEM NO.



Piston kit-Set

OEM NO. 32A17-00100



Piston	SIZE
Comp : 55.0 Height : -4.5 Length : 90.0 Top Shape : Flower Pin : 30.0 Length : 76.5	STD 0.50

Piston Ring

OEM NO.
NPR :



OEM Ring Groove	SIZE
Top : 2.5K 2nd : 2.0 Oil : 4.5	STD 0.50

Cylinder Liner

OEM NO.



Liner&Sleeve	SIZE
In Diameter : Out Diameter : Total length : Flange :	STD

Engine Bearing

MAIN : 32A09-00010
CON.ROD : 32A19-09010
T/W : 32B19-08101
C/B :
BUSH :



	SIZE
	STD

Engine Valve

OEM NO. 32A04-10100
IN 44.0 8.0 120.0
OEM NO. 32A04-11100
EX 35.0 8.0 120.0

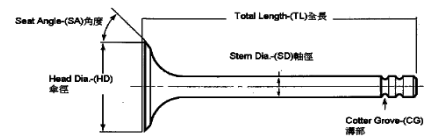

	SIZE
	STD

Valve Seat

OEM NO. 32A01-03100
IN 46.0 37.8 5.2
OEM NO. 32A01-03200
EX 37.0 30.2 6.0

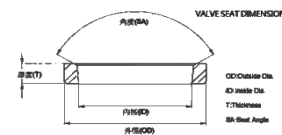

	SIZE
	STD

Valve Guide

OEM NO. 32A01-01600
IN/EX 50.0 8.0 12.0

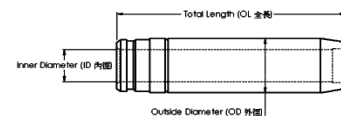

	SIZE
	STD

Gasket Set

OEM NO.



MITSUBISHI S6E2 NEW

Application :
Number of Cylinders 6
Cylinder dia. 98.0 MM
Swept Volume ccm

Piston kit-Set

OEM NO.

Piston

SIZE

Comp : 51.4 w/al-fin Height : -3.5 Length : 90.0
Top Shape : Flower
Pin : 32.0
Length : 78.0

STD

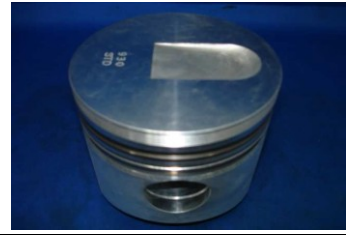

Piston Ring

OEM NO.34417-09012

NPR :

OEM Ring Groove

SIZE

Top : 3.0
2nd : 2.0
Oil : 5.0

STD



Cylinder Liner

OEM NO.

Liner&Sleeve

SIZE

In Diameter :
Out Diameter :
Total length :
Flange :

STD



Engine Bearing

MAIN : 34409-00010

CON.ROD : 34419-02100

T/W : 34409-08101

C/B :

BUSH :

SIZE

STD



Engine Valve

OEM NO. 34401-10100

IN 42.0 8.0 133.0

OEM NO. 34404-11100

EX 35.0 8.0 133.0

SIZE

STD

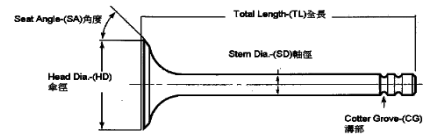

Valve Seat

OEM NO. 34401-21400

IN 44.0 37.0 6.0

OEM NO. 34401-21500

EX 37.0 30.5 6.0

SIZE

STD

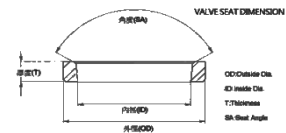

Valve Guide

OEM NO. 30601-20600

IN/EX 56.0 8.0 13.0

SIZE

STD

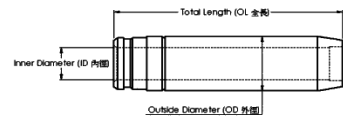

Gasket Set

OEM NO.



Piston kit-Set

OEM NO.

Piston

SIZE

Comp : 55.3 w/al-fin Height : -17.0 Length : 90.5
Top Shape : Ø54.5
Direct Injection
Pin : 30.0 Length : 76.5

STD
0.50



Piston Ring

OEM NO.

NPR :

OEM Ring Groove

SIZE

Top : 2.5K
2nd : 2.0
Oil : 4.5

STD
0.50



Cylinder Liner

OEM NO.

Liner&Sleeve

SIZE

In Diameter :
Out Diameter :
Total length :
Flange :

STD



Engine Bearing

MAIN :
CON.ROD :
T/W :
C/B :
BUSH :

SIZE

STD



Engine Valve

OEM NO.
IN
OEM NO.
EX

SIZE

STD

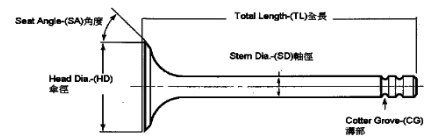

Valve Seat

OEM NO.
IN
OEM NO.
EX

SIZE

STD

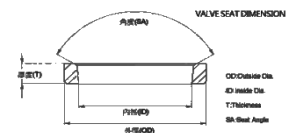

Valve Guide

OEM NO.
IN
OEM NO.
EX

SIZE

STD

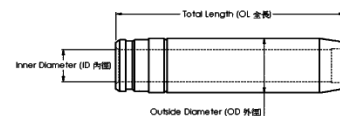

Gasket Set

OEM NO.



Piston kit-Set

OEM NO. 34317-01100

Piston

SIZE

 Comp : 58.0 w/al-fin Height : -17.5 Length : 98.0
 Shape : Ø60.5
 Direct Injection
 Pin : 34.0 Length : 84.0

STD



Piston Ring

OEM NO. 34317-19010

NPR : SDM30-108ZX

OEM Ring Groove

SIZE

 Top : 2.5K
 2nd : 2.0
 Oil : 4.0

STD



Cylinder Liner

OEM NO.

Liner&Sleeve

SIZE

 In Diameter :
 Out Diameter :
 Total length :
 Flange :

STD



Engine Bearing

 MAIN : 34309-09050
 CON.ROD : 34219-00500
 T/W : 34309-00800
 C/B : 34307-12700
 BUSH : 34319-10500

SIZE

STD



Engine Valve

 OEM NO. 36704-00200
 IN 44.0 8.0 134.0
 OEM NO. 36704-01000
 EX 37.0 8.0 134.0

SIZE

STD

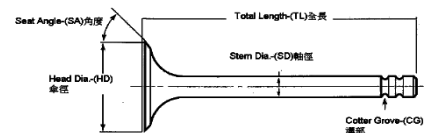

Valve Seat

 OEM NO. 36701-02800
 IN 46.0 40.0 6.7
 OEM NO. 36701-02500
 EX 39.0 33.0 6.7

SIZE

STD

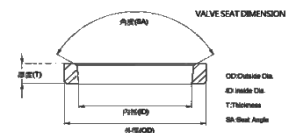

Valve Guide

 OEM NO. 34201-01600
 IN 45.0 8.0 13.0
 OEM NO. 34601-10600
 EX 56.0 8.0 13.0

SIZE

STD

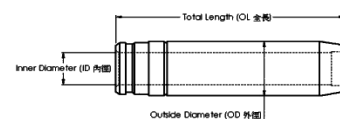

Gasket Set

OEM NO.



Piston kit-Set

OEM NO. 34317-07100

Piston

SIZE

Comp : 58.0 w/al-fin Height : -20.0 Length : 98.0 MOS2
 Shape : Ø57.3
 Direct Injection
 Pin : 34.0 Length : 84.0

STD

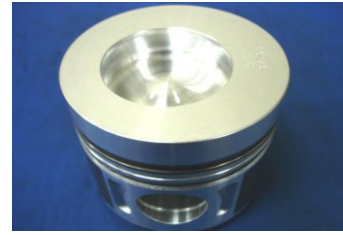

Piston Ring

OEM NO. 34317-19010

NPR : SDM30-108ZX

OEM Ring Groove

SIZE

Top : 3.0HK
 2nd : 2.0
 Oil : 4.0

STD



Cylinder Liner

OEM NO.

Liner&Sleeve

SIZE

In Diameter :
 Out Diameter :
 Total length :
 Flange :

STD



Engine Bearing

MAIN : 34309-09050
 CON.ROD : 34219-00500
 T/W : 34309-00800
 C/B : 34307-12700
 BUSH : 34319-10500

SIZE

STD



Engine Valve

OEM NO. 36704-00200
 IN 44.0 8.0 134.0
 OEM NO. 36704-01000
 EX 37.0 8.0 133.0

SIZE

STD

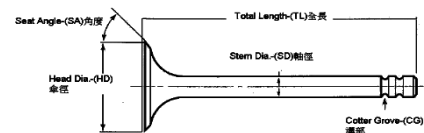

Valve Seat

OEM NO. 36701-02800
 IN 46.0 40.0 6.7
 OEM NO. 36701-02500
 EX 39.0 33.0 6.7

SIZE

STD

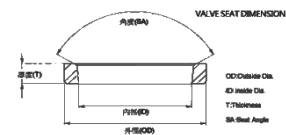

Valve Guide

OEM NO. 34201-01600
 IN 45.0 8.0 13.0
 OEM NO. 34601-10600
 EX 56.0 8.0 13.0

SIZE

STD

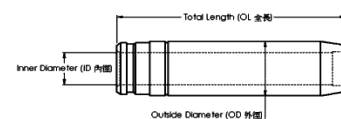

Gasket Set

OEM NO.



Piston kit-Set

OEM NO. MM434-033

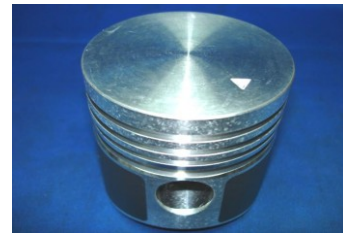

Piston

SIZE

Comp : 38.8 Height : Length : 68.0 MOS2
 Top Shape :
 Pin : 19.0
 Length : 61.0

STD

Piston Ring

OEM NO.
 NPR :



OEM Ring Groove

SIZE

Top : 2.5
 2nd : 2.5
 3rd : 2.5
 Oil : 4.0

STD

Cylinder Liner

OEM NO.



Liner&Sleeve

SIZE

In Diameter :
 Out Diameter :
 Total length :
 Flange :

STD

Engine Bearing

MAIN :
 CON.ROD : MM437-982
 T/W :
 C/B :
 BUSH :



SIZE

STD

Engine Valve

OEM NO. EVMI-45-I
 IN 27.2 6.6 114.6
 OEM NO. EVMI-45-E
 EX 25.2 6.6 114.6

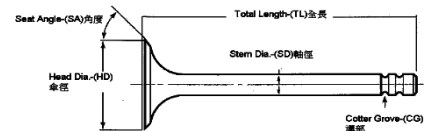

SIZE

STD

Valve Seat

OEM NO.
 IN
 OEM NO.
 EX

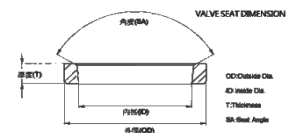

SIZE

STD

Valve Guide

OEM NO.
 IN/EX 54.5 6.6 12.0

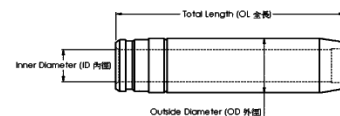

SIZE

STD

Gasket Set

OEM NO.



Piston kit-Set

OEM NO. MM435-033

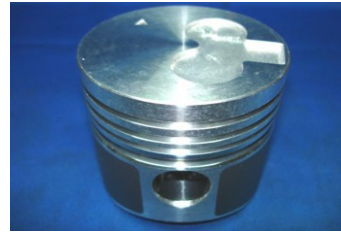

Piston	SIZE
Comp : 38.8 Height : -2.0 Length : 68.0 MOS2 Top Shape : Flower Pin : 19.0 Length :	STD

Piston Ring

OEM NO.
NPR :



OEM Ring Groove	SIZE
Top : 2.5 2nd : 2.5 3rd : 2.5 Oil : 4.0	STD

Cylinder Liner

OEM NO.



Liner&Sleeve	SIZE
In Diameter : Out Diameter : Total length : Flange :	STD

Engine Bearing

MAIN :
CON.ROD : MM437-982
T/W :
C/B :
BUSH :



	SIZE
	STD

Engine Valve

OEM NO. EVMI-45-I
IN 27.2 6.6 114.6
OEM NO. EVMI-45-E
EX 25.2 6.6 114.6

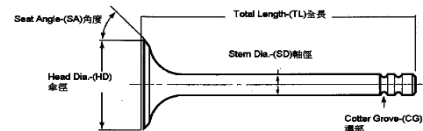

	SIZE
	STD

Valve Seat

OEM NO.
IN
OEM NO.
EX

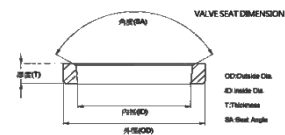

	SIZE
	STD

Valve Guide

OEM NO.
IN/EX 54.5 6.6 12.0

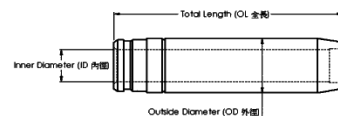

	SIZE
	STD

Gasket Set

OEM NO.



Piston kit-Set

OEM NO.

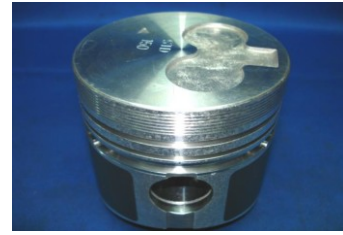

Piston

SIZE

Comp : 39.2 Height : -2.0 Length : 72.0
Top Shape : Flower
Pin : 23.0
Length : 65.0

STD
0.50

Piston Ring

OEM NO.MM433-921
NPR :



OEM Ring Groove

SIZE

Top : 2.5K
2nd : 2.0
Oil : 4.0

STD
0.50

Cylinder Liner

OEM NO.



Liner&Sleeve

SIZE

In Diameter :
Out Diameter :
Total length :
Flange :

STD

Engine Bearing

MAIN : MM437-880
CON.ROD : MM437-840
T/W :
C/B :
BUSH :



SIZE

STD

Engine Valve

OEM NO. EVMI-105-I
IN 32.0 6.6 114.6
OEM NO. EVMI-105-E
EX 27.0 6.6 114.6

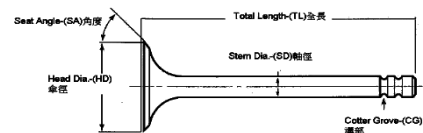

SIZE

STD

Valve Seat

OEM NO.
IN
OEM NO.
EX

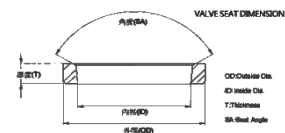

SIZE

STD

Valve Guide

OEM NO.
IN
OEM NO.
EX

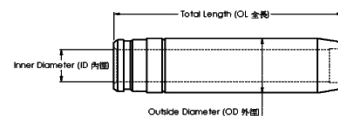

SIZE

STD

Gasket Set

OEM NO.



Piston kit-Set

OEM NO. MM437-779



Piston

SIZE

Comp : 42.9 Height : -1.9 Length : 80.0 MOS2
Top Shape : Flower
Pin : 23.0
Length : 65.0

STD
0.50

Piston Ring

OEM NO. MM433-921

NPR :



OEM Ring Groove

SIZE

Top : 2.5HK
2nd : 2.0
Oil : 4.0

STD

Cylinder Liner

OEM NO.



Liner&Sleeve

SIZE

In Diameter :
Out Diameter :
Total length :
Flange :

STD

Engine Bearing

MAIN :
CON.ROD :
T/W :
C/B :
BUSH :

SIZE



STD

Engine Valve

OEM NO.
IN 30.2 8.0 112.4
OEM NO.
EX 28.2 8.0 112.4

SIZE

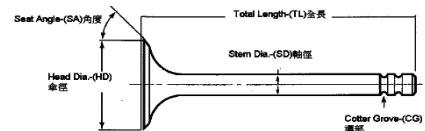

STD

Valve Seat

OEM NO.
IN
OEM NO.
EX

SIZE

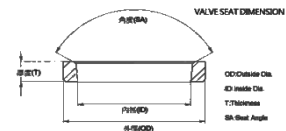

STD

Valve Guide

OEM NO.
IN
OEM NO.
EX

SIZE

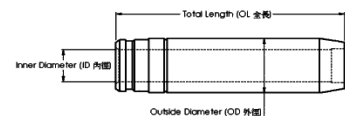

STD

Gasket Set

OEM NO.



Piston kit-Set

OEM NO. MM437007



Piston	SIZE
Comp : 43.5 Height : Length : 90.0 Top Shape : Flower Pin : 23.0 Length : 65.0	STD 0.50

Piston Ring

OEM NO.
NPR :



OEM Ring Groove	SIZE
Top : 2.5K 2nd : 2.0 Oil : 4.0	STD

Cylinder Liner

OEM NO.



Liner&Sleeve	SIZE
In Diameter : Out Diameter : Total length : Flange :	STD

Engine Bearing

MAIN : MM43866400
CON.ROD : MM48367100
T/W :
C/B :
BUSH :



	SIZE
	STD

Engine Valve

OEM NO.
IN 30.2 8.0 112.4
OEM NO.
EX 28.2 8.0 112.4

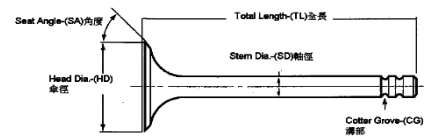

	SIZE
	STD

Valve Seat

OEM NO.
IN
OEM NO.
EX

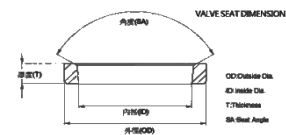

	SIZE
	STD

Valve Guide

OEM NO.
IN
OEM NO.
EX

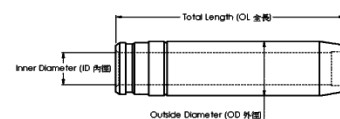

	SIZE
	STD

Gasket Set

OEM NO.



Piston kit-Set

OEM NO.

Piston

SIZE

Comp : 39.5 Height : Length : 68.0
Top Shape : Flower
Pin : 19.0
Length : 64.0

STD

Piston Ring

OEM NO.

NPR :

OEM Ring Groove

SIZE

Top : 2.5
2nd : 2.5
3rd : 2.5
Oil : 4.0

STD



Cylinder Liner

OEM NO.

Liner&Sleeve

SIZE

In Diameter :
Out Diameter :
Total length :
Flange :

STD



Engine Bearing

MAIN :
CON.ROD :
T/W :
C/B :
BUSH :

SIZE

STD



Engine Valve

OEM NO.

IN 32.4 6.6 114.6

OEM NO.

EX 27.2 6.6 114.6

SIZE

STD

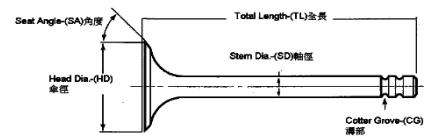

Valve Seat

OEM NO.

IN

OEM NO.

EX

SIZE

STD

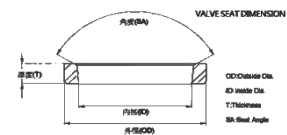

Valve Guide

OEM NO.

IN/EX 54.5 6.6 12.0

SIZE

STD

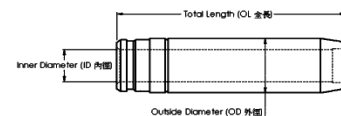

Gasket Set

OEM NO.



Piston kit-Set

OEM NO.

Piston

SIZE

Comp : 39.5 Height : -1.0 Length : 72.0
Top Shape : Flower
Pin : 19.0
Length : 64.0

STD



Piston Ring

OEM NO.

NPR :

OEM Ring Groove

SIZE

Top : 2.5K
2nd : 2.0
3rd : 2.0
Oil : 4.0

STD



Cylinder Liner

OEM NO.

Liner&Sleeve

SIZE

In Diameter :
Out Diameter :
Total length :
Flange :

STD



Engine Bearing

MAIN :
CON.ROD :
T/W :
C/B :
BUSH :

SIZE

STD



Engine Valve

OEM NO.

IN 32.4 6.6 114.6

OEM NO.

EX 27.2 6.6 114.6

SIZE

STD

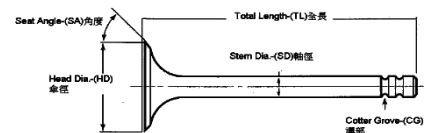

Valve Seat

OEM NO.

IN

OEM NO.

EX

SIZE

STD

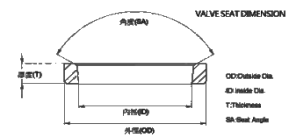

Valve Guide

OEM NO.

IN/EX 54.5 6.6 12.0

SIZE

STD

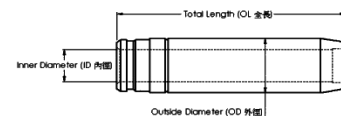

Gasket Set

OEM NO.



Piston kit-Set

OEM NO.

Piston

SIZE

Comp : 39.5 Height : -1.0 Length : 72.0
Top Shape : Flower
Pin : 19.0
Length : 64.0

STD



Piston Ring

OEM NO.

NPR :

OEM Ring Groove

SIZE

Top : 2.5K
2nd : 2.0
3rd : 2.0
Oil : 4.0

STD



Cylinder Liner

OEM NO.

Liner&Sleeve

SIZE

In Diameter :
Out Diameter :
Total length :
Flange :

STD



Engine Bearing

MAIN :
CON.ROD :
T/W :
C/B :
BUSH :

SIZE

STD



Engine Valve

OEM NO.

IN 32.4 6.6 114.6

OEM NO.

EX 27.2 6.6 114.6

SIZE

STD

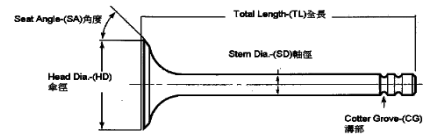

Valve Seat

OEM NO.

IN

OEM NO.

EX

SIZE

STD

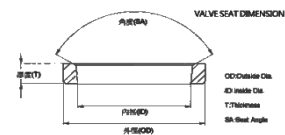

Valve Guide

OEM NO.

IN/EX 54.5 6.6 12.0

SIZE

STD

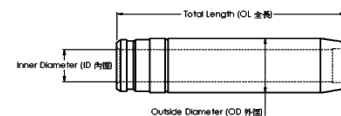

Gasket Set

OEM NO.



Piston kit-Set

OEM NO. 30A17-00050



Piston	SIZE
Comp : 39.0 Height : -1.5 Length : 72.0 Top Shape : Flower Pin : 23.0 Length : 62.0	STD

Piston Ring

OEM NO.MM431-579
NPR :



OEM Ring Groove	SIZE
Top : 2.5K 2nd : 2.0 Oil : 4.0	STD

Cylinder Liner

OEM NO.



Liner&Sleeve	SIZE
In Diameter : Out Diameter : Total length : Flange :	STD

Engine Bearing

MAIN : MM437-313
CON.ROD : MM437-983
T/W : TW-622A
C/B :
BUSH : MM430-313



	SIZE
	STD

Engine Valve

OEM NO. EVMI-45-I
IN 27.2 6.6 114.6
OEM NO. EVMI-45-E
EX 25.2 6.6 114.6

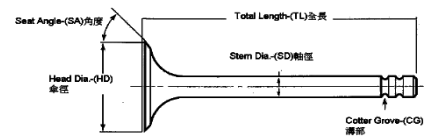

	SIZE
	STD

Valve Seat

OEM NO.
IN
OEM NO.
EX

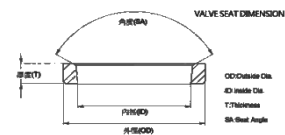

	SIZE
	STD

Valve Guide

OEM NO.
IN/EX 54.5 6.6 12.0

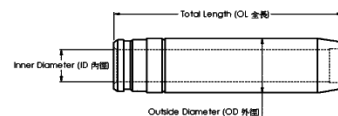

	SIZE
	STD

Gasket Set

OEM NO.



Piston kit-Set

OEM NO.

Piston

SIZE

Comp : 39.0 Height : -13.5 Length : 72.0
Top Shape : Ø39.0
Direct Injection
Pin : 23.0 Length : 62.0

STD
0.50



Piston Ring

OEM NO.MM431-579

NPR :

OEM Ring Groove

SIZE

Top : 2.5K
2nd : 2.0
Oil : 4.0

STD



Cylinder Liner

OEM NO.

Liner&Sleeve

SIZE

In Diameter :
Out Diameter :
Total length :
Flange :

STD



Engine Bearing

MAIN : MM437-313
CON.ROD : MM437-983
T/W : TW-622A
C/B :
BUSH : MM430-313

SIZE

STD



Engine Valve

OEM NO.

IN 32.4 6.6 114.6

OEM NO.

EX 27.2 6.6 114.6

SIZE

STD

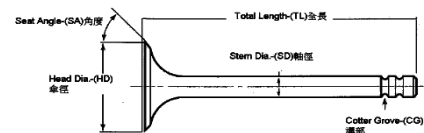

Valve Seat

OEM NO.

IN

OEM NO.

EX

SIZE

STD

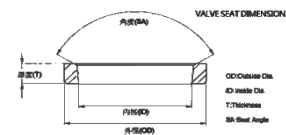

Valve Guide

OEM NO.

IN/EX 54.5 6.6 12.0

SIZE

STD

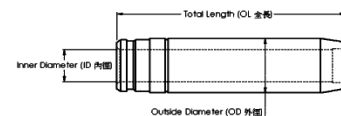

Gasket Set

OEM NO.



Piston kit-Set

OEM NO.

Piston	SIZE
Comp : 38.5 Height : -13.5 Length : 72.0 Top Shape : Ø35.0 Direct Injection Pin : 23.0 Length : 65.0	STD 0.50



Piston Ring

OEM NO.MM433-921

NPR :

OEM Ring Groove	SIZE
Top : 2.5HK 2nd : 2.0 Oil : 4.0	STD 0.50



Cylinder Liner

OEM NO.

Liner&Sleeve	SIZE
In Diameter : Out Diameter : Total length : Flange :	STD



Engine Bearing

MAIN : MM437-880
 CON.ROD : MM437-840
 T/W :
 C/B :
 BUSH :

SIZE
STD



Engine Valve

OEM NO.
 IN 32.4 6.6 114.6
 OEM NO.
 EX 27.2 6.6 114.6

SIZE
STD

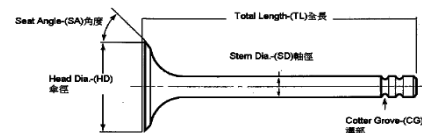

Valve Seat

OEM NO.
 IN
 OEM NO.
 EX

SIZE
STD

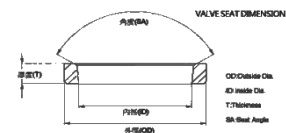

Valve Guide

OEM NO.
 IN/EX 54.5 6.6 12.0

SIZE
STD

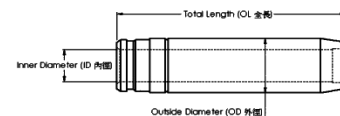

Gasket Set

OEM NO.



Piston kit-Set

OEM NO. 30A17-00190

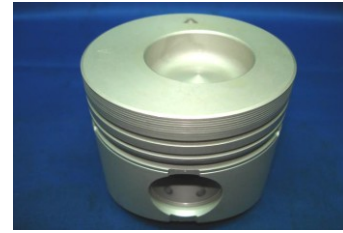

Piston	SIZE
Comp : 43.5 Height : -14.0 Length : 72.0 Top Shape : Ø39.0 Direct Injection Pin : 27.0 Length : 64.0	STD 0.50

Piston Ring

OEM NO.MM433-921

NPR :



OEM Ring Groove	SIZE
Top : 2.5HK 2nd : 2.0 Oil : 4.0	STD 0.50

Cylinder Liner

OEM NO.



Liner&Sleeve	SIZE
In Diameter : Out Diameter : Total length : Flange :	STD

Engine Bearing

MAIN :
CON.ROD :
T/W :
C/B :
BUSH :



	SIZE
	STD

Engine Valve

OEM NO.
IN 32.4 6.6 114.6
OEM NO.
EX 27.2 6.6 114.6

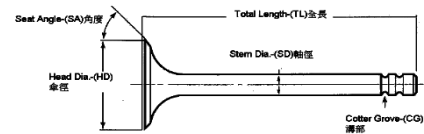

	SIZE
	STD

Valve Seat

OEM NO.
IN
OEM NO.
EX

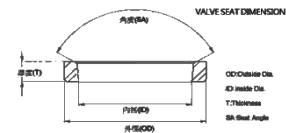

	SIZE
	STD

Valve Guide

OEM NO.
IN/EX 54.5 6.6 12.0

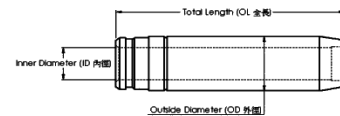

	SIZE
	STD

Gasket Set

OEM NO.



Piston kit-Set

OEM NO.

Piston

SIZE

Comp : 44.5 Height : Length : 80.0

Top Shape : Ø

Pin :

Length :

STD

Piston Ring

OEM NO.

NPR :

OEM Ring Groove

SIZE

Top :

2nd :

Oil :

STD



Cylinder Liner

OEM NO.

Liner&Sleeve

SIZE

In Diameter :

Out Diameter :

Total length :

Flange :

STD



Engine Bearing

MAIN :

CON.ROD :

T/W :

C/B :

BUSH :

SIZE

STD



Engine Valve

OEM NO.

IN 32.0 6.6 114.6

OEM NO.

EX 27.0 6.6 114.6

SIZE

STD

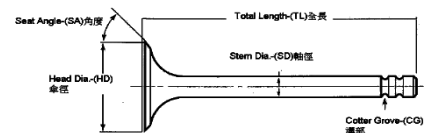

Valve Seat

OEM NO.

IN

OEM NO.

EX

SIZE

STD

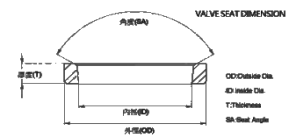

Valve Guide

OEM NO.

IN

OEM NO.

EX

SIZE

STD

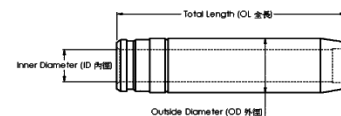

Gasket Set

OEM NO.



Piston kit-Set

OEM NO.

Piston

SIZE

Comp : 46.5 Height : -16.5 Length : 83.0
Top Shape : Ø42.8
Pin : 27.0
Length : 64.0

STD

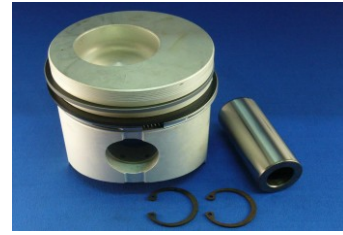

Piston Ring

OEM NO.

NPR :

OEM Ring Groove

SIZE

Top :
2nd :
Oil :

STD



Cylinder Liner

OEM NO.

Liner&Sleeve

SIZE

In Diameter :
Out Diameter :
Total length :
Flange :

STD



Engine Bearing

MAIN : MM438-664
CON.ROD : MM438-671
T/W :
C/B :
BUSH :

SIZE

STD



Engine Valve

OEM NO.OK65A-12-111A
IN 34.0 8.0 113.0
OEM NO.OK65A-12-121B
EX 29.0 8.0 112.5

SIZE

STD

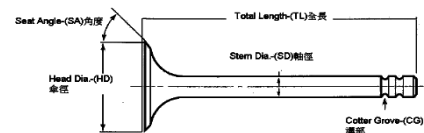

Valve Seat

OEM NO.
IN
OEM NO.
EX

SIZE

STD

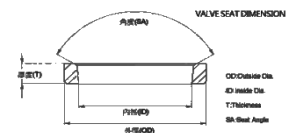

Valve Guide

OEM NO. MM408444
IN/EX 49.0 8.0 14.0

SIZE

STD

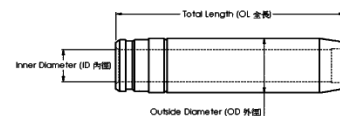

Gasket Set

OEM NO.



Piston kit-Set

OEM NO.

Piston

SIZE

Comp : 46.5 Height : -16.5 Length : 86.0
Top Shape : Ø46.0
Direct Injection
Pin : 27.0 Length : 68.0

STD
0.50



Piston Ring

OEM NO.MM438-689

NPR :

OEM Ring Groove

SIZE

Top : 2.5K
2nd : 2.0
Oil : 4.0

STD
0.50



Cylinder Liner

OEM NO.

Liner&Sleeve

SIZE

In Diameter :
Out Diameter :
Total length :
Flange :

STD



Engine Bearing

MAIN : MM438-664
CON.ROD : MM438-671
T/W :
C/B :
BUSH :

SIZE

STD



Engine Valve

OEM NO.OK65A-12-111A
IN 34.0 8.0 113.0
OEM NO.OK65A-12-121B
EX 29.0 8.0 112.5

SIZE

STD

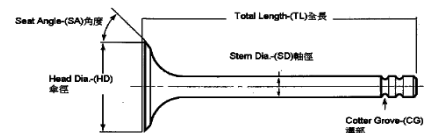

Valve Seat

OEM NO.
IN
OEM NO.
EX

SIZE

STD

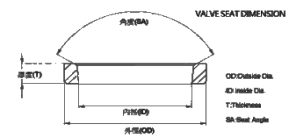

Valve Guide

OEM NO. MM408444
IN/EX 49.0 8.0 14.0

SIZE

STD

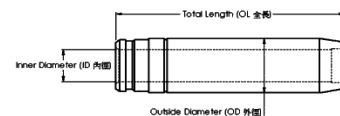

Gasket Set

OEM NO.



MITSUBISHI K4Q(4DQ7)

Application :
Number of Cylinders 4
Cylinder dia. 88.0 MM
Swept Volume ccm

Piston kit-Set

OEM NO.

Piston

SIZE

Comp : 45.3 Height : -3.5 Length : 80.6
 Top Shape : Flower
 Pin : 25.0
 Length : 70.0

STD



Piston Ring

OEM NO.

NPR :

OEM Ring Groove

SIZE

Top :
 2nd :
 Oil :

STD



Cylinder Liner

OEM NO.

Liner&Sleeve

SIZE

In Diameter :
 Out Diameter :
 Total length :
 Flange :

STD



Engine Bearing

MAIN :
 CON.ROD :
 T/W :
 C/B :
 BUSH :

SIZE

STD



Engine Valve

OEM NO.30604-00100
 IN 40.0 8.0 118.0
 OEM NO.30604-01101
 EX 31.0 8.0 118.0

SIZE

STD

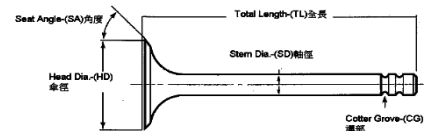

Valve Seat

OEM NO. 30601-10400
 IN 41.0 37.0 5.0
 OEM NO. 30601-10500
 EX 33.0 28.0 5.0

SIZE

STD

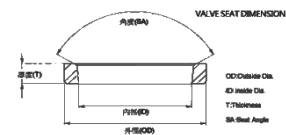

Valve Guide

OEM NO. 30601-20600
 IN/EX 56.0 8.0 13.0

SIZE

STD

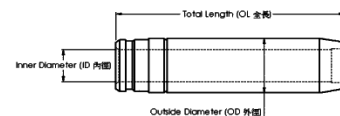

Gasket Set

OEM NO.



Piston kit-Set

OEM NO.

Piston

SIZE

Comp : 34.5 Height : -1.5 Length : 64.5
Top Shape : Flower
Pin : 18.0
Length : 63.0

STD



Piston Ring

OEM NO.

NPR :

OEM Ring Groove

SIZE

Top : 2.0
2nd : 2.0
Oil : 3.0

STD



Cylinder Liner

OEM NO.

Liner&Sleeve

SIZE

In Diameter :
Out Diameter :
Total length :
Flange :

STD



Engine Bearing

MAIN :
CON.ROD :
T/W :
C/B :
BUSH :

SIZE

STD



Engine Valve

OEM NO. 30L06-01100
IN 26.7 6.6 94
OEM NO. 30L06-01200
EX 24.7 6.6 94

SIZE

STD

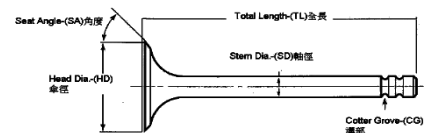

Valve Seat

OEM NO.
IN
OEM NO.
EX

SIZE

STD

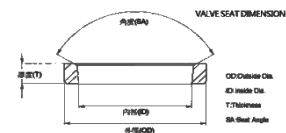

Valve Guide

OEM NO.
IN
OEM NO.
EX

SIZE

STD

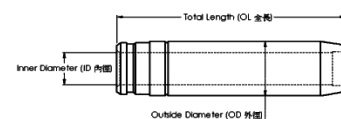

Gasket Set

OEM NO.

