



Taiwan Excellent Auto Engine Parts
Warranty for

2 Year / 20,000 km

NISSAN UD

Diesel Engine Parts

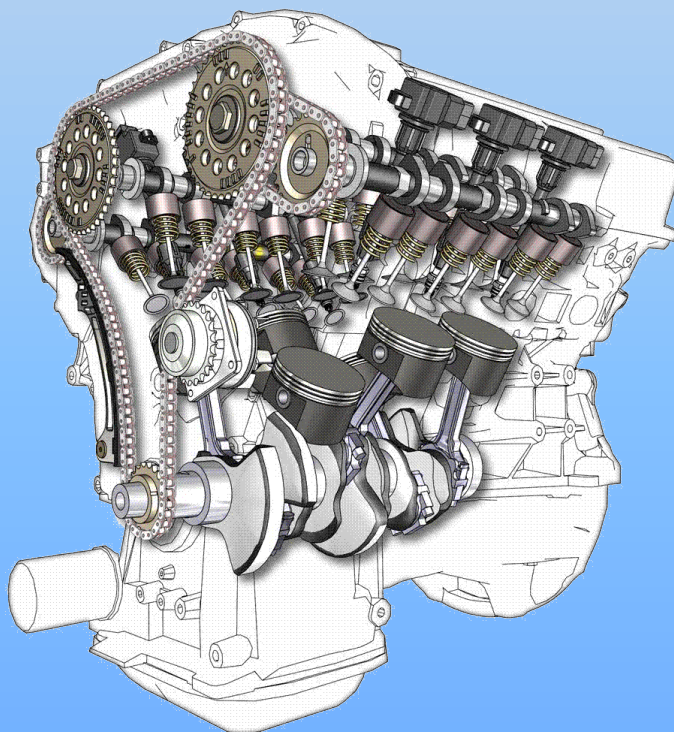

Contact Person: Mr. Jacky Tsai
Email 1: eton.jacky@msa.hinet.net
Email 2: valveparts2866@gmail.com
Tel : (8864) 2293-6969
Fax : (8864) 2293-7070
No. 90, Wenchang 1st St., North District,
Taichung City, Taiwan. 40464

E & T SCIENCE INC.

ISO/TS 16949
QS9000



PISTON TERMINOLOGY

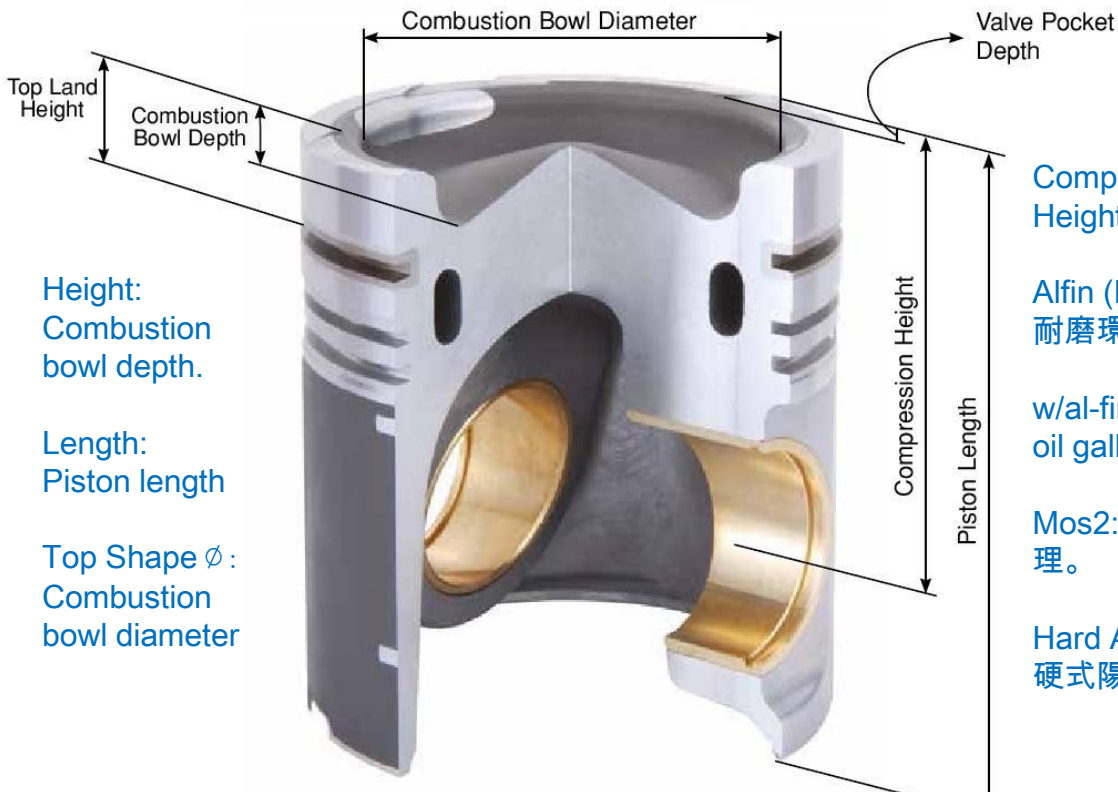
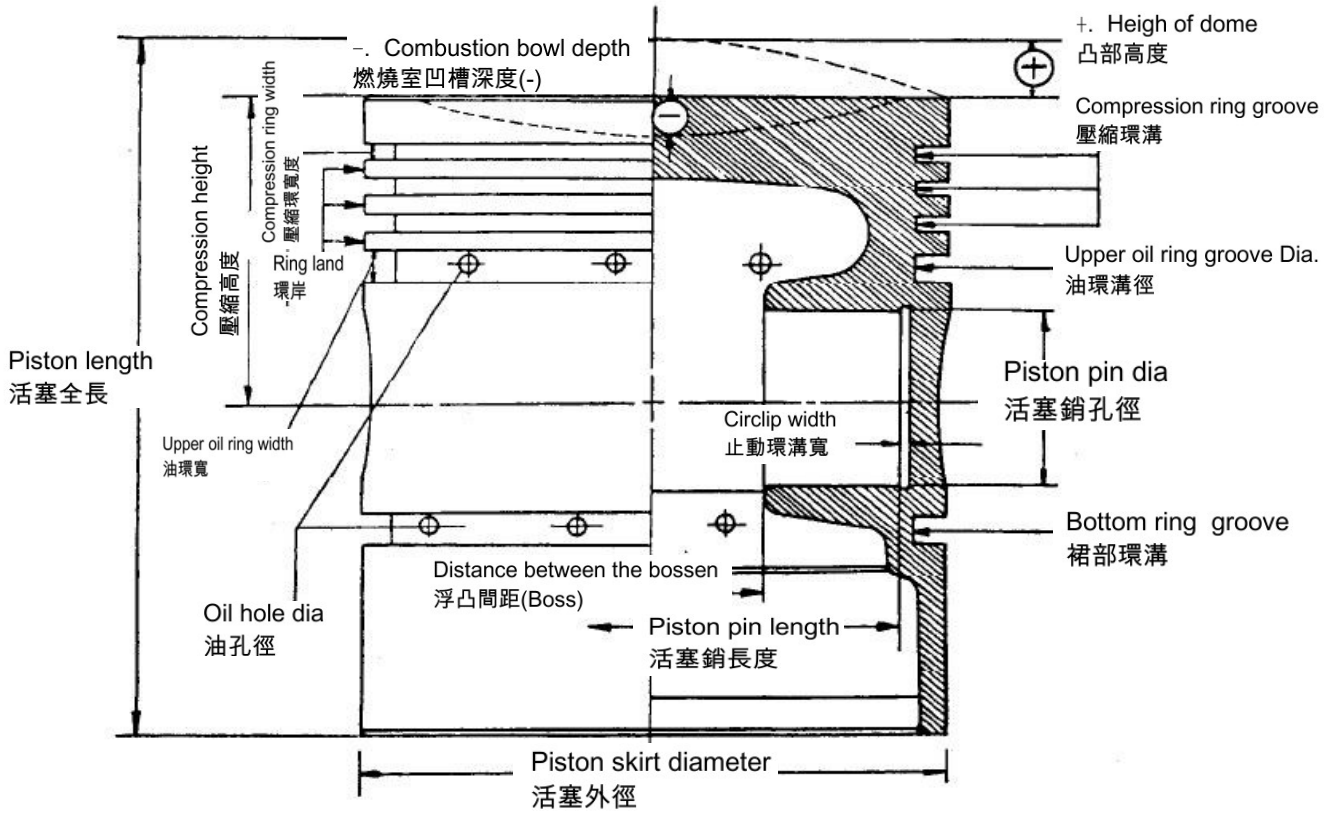



PISTON RING TERMINOLOGY

Free Ring(Unstressed)

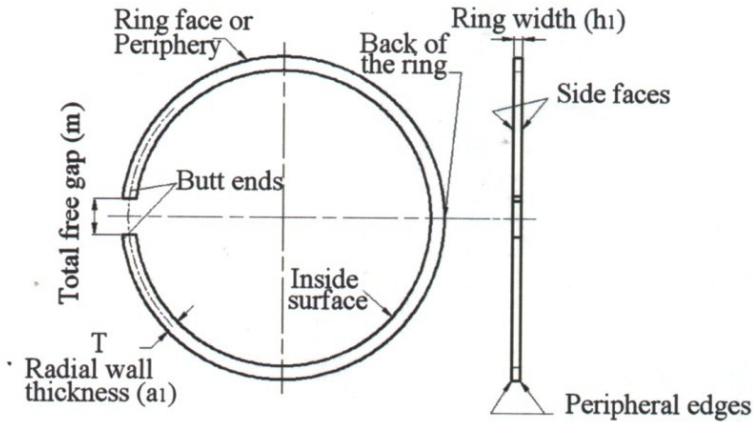

Closed Ring

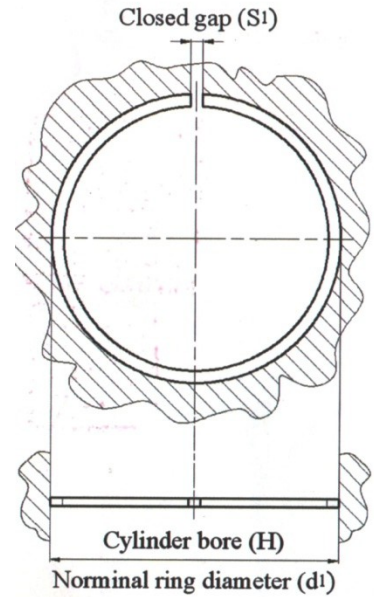

Compression Ring

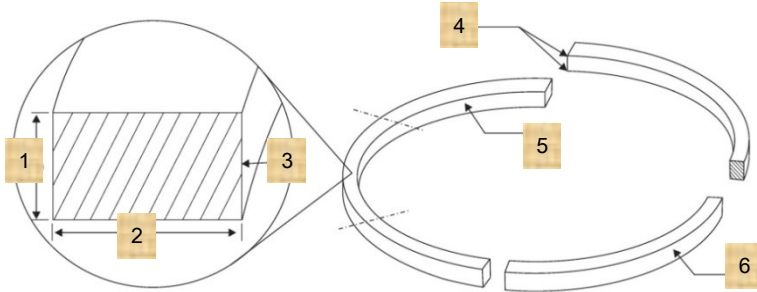

- 1. Piston ring width
- 2. Piston ring thickness
- 3. Inside edge of gap
- 4. Inside edges
- 5. Inside surface
- 6. Peripheral surface

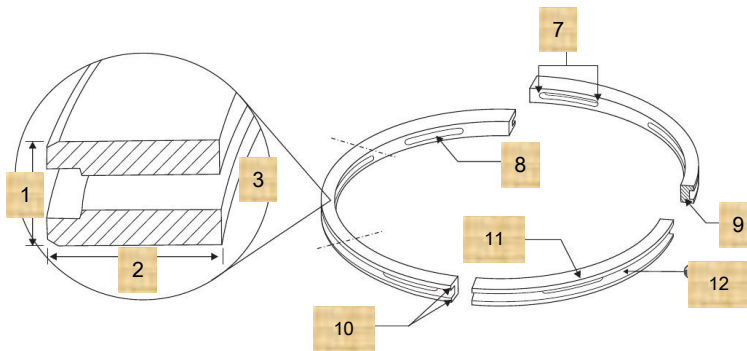

- 7. Inside edges of slot
- 8. Slot face
- 9. Gap face
- 10. Outside gap corners
- 11. Side face
- 12. Outside groove face

Oil Control Ring



LINER/SLEEVE TERMINOLOGY

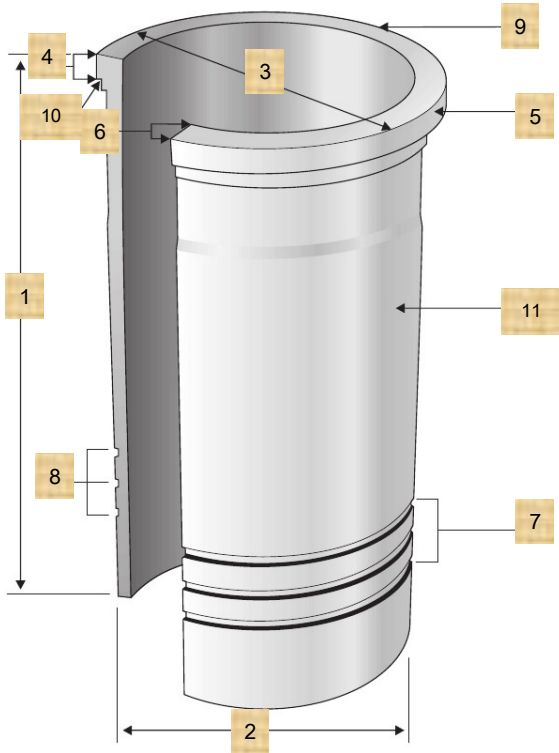

- 1. Total length
- 2. Outside diameter
- 3. Flange diameter
(Register diameter)
- 4. Flange depth
(Collar height)
- 5. Flange
- 6. Top land width
- 7. Sealing area
- 8. O-Ring groove
- 9. Firewall
- 10. Machining relief
- 11. Barel



Wet Cylinder Liner

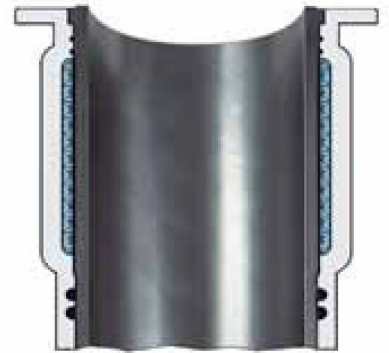

Dry Cylinder Liner

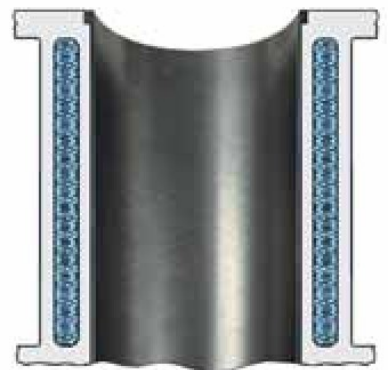



BEARINGS TERMINOLOGY



Rocker arm bushes



Con rod bushes



Connecting rod bearing



Main bearing



Flanged bearing



Thrust washers



Camshaft bearing

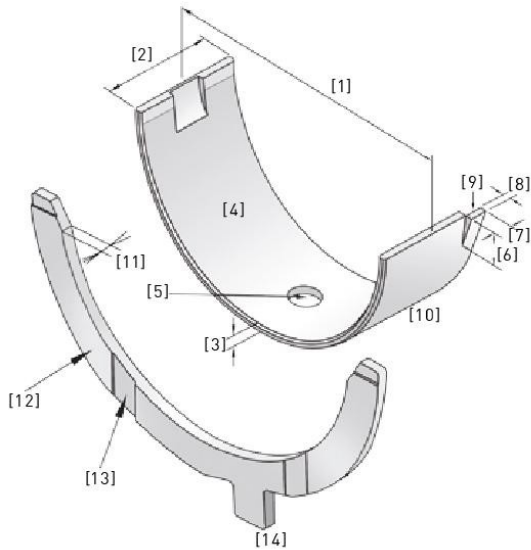

Bearing Shell

1. Free spread
2. Bearing length
3. Bearing wall thickness
4. Bearing surface
5. Lubrication hole
6. Length of locating lug
7. Width of locating lug
8. Height of locating lug
9. Locating lug relief
10. Bearing back

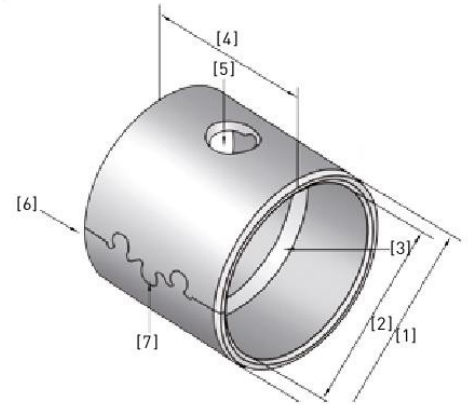

Bushing

1. Outside diameter
2. Inside diameter
3. Oil groove
4. Bushing length
5. Lubrication hole
6. Joint
7. Clinch

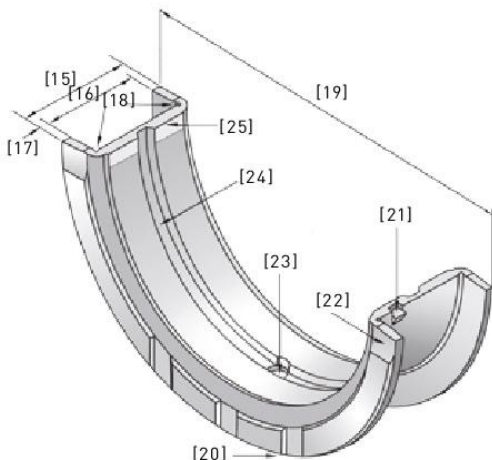

Flange Bearing

15. Flange bearing length
16. Distance between flange
17. Flange thickness
18. Flange relief grooves
19. Flange diameter
20. Relief at joint face
21. Locating lug
22. Relief at joint face
23. Lubrication hole
24. Oil groove
25. Relief at surface
26. Flange and Bearing assembly

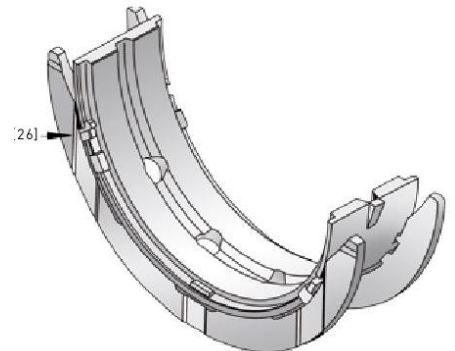



ENGINE VALVE SPECIFICATION

ENGINE VALVE DIMENSION

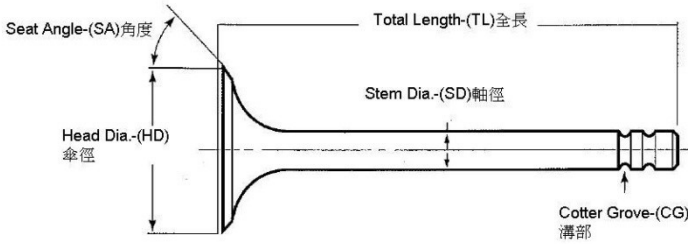

Stem Top Hardness:
HRC 45~60

Roundness Tolerance
 ≤ 0.005 mm

Roundness Tolerance
 ≤ 0.005 mm

Straightness Tolerance
 ≤ 0.005 mm

Straightness Tolerance
 ≤ 0.005 mm

Concentricity Tolerance
 ≤ 0.05 mm

Concentricity Tolerance
 ≤ 0.05 mm

SPECIFICATION



SHAPE OF COTTER GROOVE (CG)

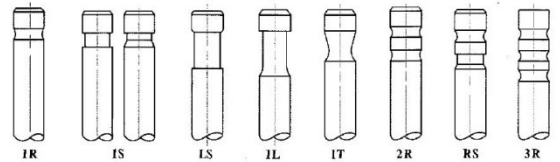

引擎汽門(Engine Valve)使用鋼材對照

材料代號對照					材料化學成分								適用於
Martensitic Steel 麻田散鐵													IN/EX
ISO	JIS	SAE	DIN/BS	大陸	C	Si	Mn	P	S	Ni	Cr	Mo	
42CrMo4	SCM440	4140	EN49		0.43	0.35	0.85				1.2	0.3	
X45CrSi93	SUH1	HNV3	X45CrSi9 3	45Cr9Si3	0.4-0.5	3.0-3.5	≤ 0.60	≤ 0.03	≤ 0.03	≤ 0.5	7.5-9.0		
	SUH3		X40CrSiMo10-2	40Cr10Si2Mo	0.30-0.45	1.8-2.5	≤ 0.60	≤ 0.03	≤ 0.03	≤ 0.6	10.0-12.0	0.7-1.3	
	SUH4(XB)	ENV6	EN59	80Cr20Si2Ni	0.75-0.85	1.75-2.25	0.2-0.6	≤ 0.03	≤ 0.03	1.15-1.65	19.0-20.5		
X50CrSi82	SUH11	HNV3	EN52	51Cr8Si2	0.45-0.55	1.0-2.0	≤ 0.60	≤ 0.03	≤ 0.03		7.5-9.5		
Austenitic Steel 奧斯田鐵 Non-magnetic													EX
	SUH31	EV9		45Cr14Ni14W2Mo	0.3-0.45	1.5-2.5	≤ 0.60	≤ 0.04	≤ 0.03	13.0-15.0	14.0-16.0		
X53CrMnNiN214	SUH35(21-4N)	EV8	349S54	53Cr21Mn9Ni4N	0.58	≤ 0.35	8.0-10.0	≤ 0.01	≤ 0.03	3.25-4.5	20.0-22.0		
	SUH37(21-12N)	EV4	381S34	20Cr21Ni12N	0.15-0.25	0.75-1.0	1.0-1.5	≤ 0.025	≤ 0.025	10.5-12.5	20.0-22.0		
	SUH38				0.25-0.35	≤ 1.0	≤ 1.2	0.18-0.25	≤ 0.03	10.0-12.0	19.0-21.0	1.8-2.5	
Nickel Basic alloy 鎳基合金													EX
NiCr20TiAl	NiMonic 80A	2.4952(HEV5)		GH4080A	0.10max	1.0	1.0		Fe 3.0 max	65.0min	18.0-21.0	Al 1.0-1.5	
NiCr15Fe7TiAl	751	2.4669(HEV3)	NiCr15FeTiAl	GH4751									

STELLITE 鈷鉻鎢合金鋼(軸端與盤面焊補材質)						
	C	Cr	W	Fe	Co	HRC
Stellite #1	2.5	30.0	12.0	3.0 Max	Balance	54
Stellite #6	1.0	28.0	4.0	3.0 Max	Balance	44
Stellite #12	1.35	29.0	8.0	2.0	Balance	47



VALVE SEAT & GUIDE SPECIFICATION

Valve Seat:
High Chrome Alloy Steel
Hardness :HRC 36~47

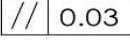
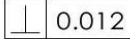
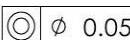
-  0.03 Parallelism Tolerance $\leq 0.03\text{mm}$
-  0.012 Verticality Tolerance $\leq 0.012\text{mm}$
-  ϕ 0.05 Concentricity Tolerance $\leq 0.05\text{mm}$

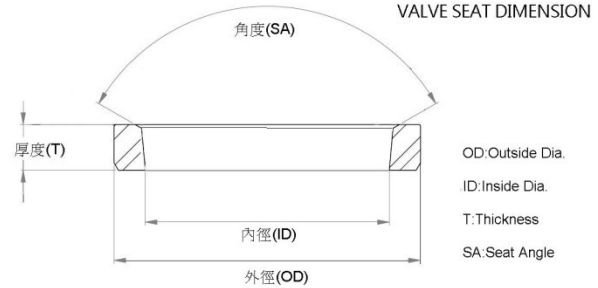

Valve Seat Material

汽門座圈材料成份表

材質:高鉻合金High Chrome Alloy Steel(耐熱合金鑄造鋼)



	C	Si	Mn	P	S	Cr	Mo	Ni	V	Hardness 硬度HRC
高鉻合金 High Chrome Alloy Steel	1.5~2.0	1.5~2.0	0.6~1.2	≤ 0.10	≤ 0.10	13.5~15	0.35~0.5			36~47

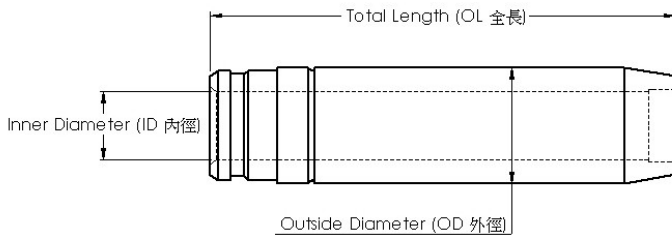

(mm)	Inlet valve (μm)	Exhaust valve (μm)
Stem dia. 6 - 7	10 - 40	25 - 55
Stem dia. 8 - 9	20 - 50	35 - 65
Stem dia. 10 - 12	40 - 70	55 - 85

Valve Guide: Cast Iron FC25

Hardness :HRB 92~102°

- Surface finish Ra $\leq 0.8\mu\text{m}$
- Inner diameter tolerance $\leq 0.01\text{mm}$
- Outer diameter tolerance $\leq 0.01\text{mm}$
- Concentricity diameter tolerance $\leq 0.05\text{mm}$

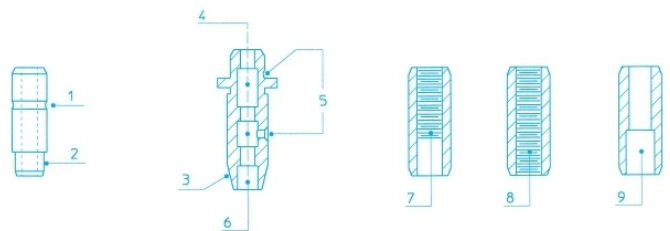

- 1.Outer groove for snap ring
- 2.Narrower end
- 3.Conical end
- 4.Recessd area in the bore
- 5.Lubrifation holes
- 6.Counterbore at end of guides
- 7/8.Lubrifation threads
- 9.Counter bore

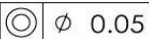
 ϕ 0.05

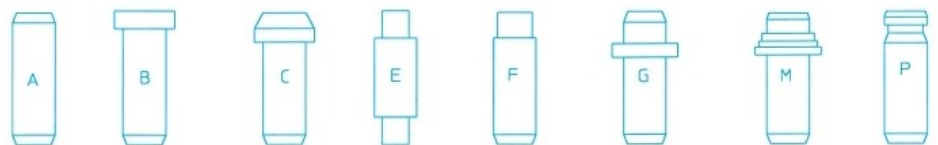



NISSAN DIESEL ENGINE PARTS

TYPE	NO	TYPE	NO
BD25	1	YD25	96~99
BD30	2~3	ZD30	100~101
CD20	4		
ED30	5		
ED33	6~8		
FD6	9~13		
FD33	14~15		
FD35	16~18		
FD42	19~20		
FD46	21~24		
FE6	25~32		
LD20	33~34		
LD28	35		
ND6	36~37		
NE6	38~41		
NF6	42		
PD6	43~44		
PE6	45~50		
PF6	51~58		
QD32	59		
RD8	60~62		
RD28	63		
RE8	64		
RF8	65~69		
RG8	70		
RH8;RH10	71		
SD22	72~73		
SD23	74~75		
SD25	76		
TD23	77		
TD25	78~81		
TD27	82~88		
TD42	89~90		
UD3	91~92		
YD22	93~95		

NISSAN BD25

Application :
Number of Cylinders 4
Cylinder dia. 92.9 MM
Swept Volume 2953 ccm

Piston kit-Set

OEM NO. 12010-87G01



Piston

SIZE

Comp : 53.0 w/al-fin Height : -15.7 Length : 90.0
Top Shape : Ø43.5
Direct Injection
Pin : 30.0 Length : 80.0

STD

Piston Ring

OEM NO.
NPR :



OEM Ring Groove

SIZE

Top : 2.5
2nd : 2.0
Oil : 4.0

STD

Cylinder Liner

OEM NO. 11012-87G00



Liner&Sleeve

SIZE

In Diameter : 92.9
Out Diameter : 95.9
Total length : 160.5
Flange : 102.0*5.0

STD

Engine Bearing

MAIN :
CON.ROD :
T/W :
C/B :
BUSH :



SIZE

STD

Engine Valve

OEM NO. 13201-02N00B
IN 40.0 8.0 117.0
OEM NO. 13202-87G01B
EX 37.0 8.0 117.0

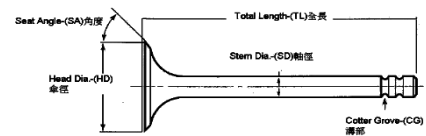

SIZE

STD

Valve Seat

OEM NO.
IN
OEM NO.
EX

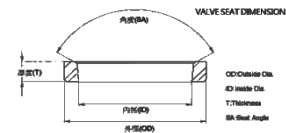

SIZE

STD

Valve Guide

OEM NO. 13212-43G01
IN/EX 47.0 8.0 12.0

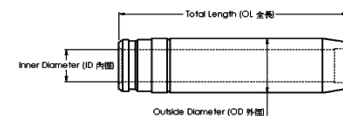

SIZE

STD

Gasket Set

OEM NO.



NISSAN BD30

Application :
Number of Cylinders 4
Cylinder dia. 96.0 MM
Swept Volume 2953 ccm

Piston kit-Set

OEM NO. 12010-54T00

Piston

SIZE

Comp : 53.1 oil-cooled Height : -20.0 Length : 89.5
 Top Shape : Ø44.0
 Direct Injection
 Pin : 30.0 Length : 80.0

STD



Piston Ring

OEM NO. 12033-54T10

NPR : SDN30-150ZX

OEM Ring Groove

SIZE

Top : 2.5
 2nd : 2.0
 Oil : 4.0

STD



Cylinder Liner

OEM NO. 11012-54T00

Liner&Sleeve

SIZE

In Diameter : 96.0
 Out Diameter : 99.0
 Total length : 172.4
 Flange : 105.0*5.0

STD



Engine Bearing

MAIN :
 CON.ROD :
 T/W :
 C/B :
 BUSH :

SIZE

STD



Engine Valve

OEM NO. 13201-43G01

IN 43.5 8.0 117.0

OEM NO. 13202-43G01

EX 38.0 8.0 117.0

SIZE

STD

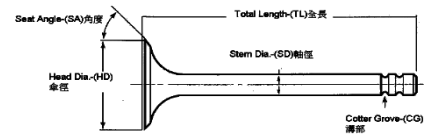

Valve Seat

OEM NO. 11098-54T01

IN 44.5 38.0 7.0

OEM NO. 11099-43G00

EX 39.5 33.0 8.0

SIZE

STD

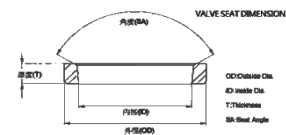

Valve Guide

OEM NO. 13212-43G01

IN/EX 47.0 8.0 12.0

SIZE

STD

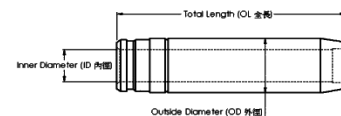

Gasket Set

OEM NO.



Piston kit-Set

OEM NO. 12010-69T05



Piston

SIZE

Comp : 53.4 w/al-fin Height : -21.3 oil-cooled Length : 89.5
Top Shape : Ø47.0
Direct Injection
Pin : 30.0 Length : 80.0

STD

Piston Ring

OEM NO. 12033-2W211
NPR : SDN30-153ZZ



OEM Ring Groove

SIZE

Top : 2.5HK
2nd : 2.0
Oil : 4.0

STD

Cylinder Liner

OEM NO. 11012-54T00



Liner&Sleeve

SIZE

In Diameter : 96.0
Out Diameter : 99.0
Total length : 172.4
Flange : 105.0*5.0

STD

Engine Bearing

MAIN : 12207-54T10
CON.ROD : 12111-43G01
T/W : 12280-37525
C/B : 13002-43G00
BUSH :



SIZE

STD

Engine Valve

OEM NO. 13201-43G01
IN 43.5 8.0 117.0
OEM NO. 13202-43G02
EX 38.8 8.0 117.0

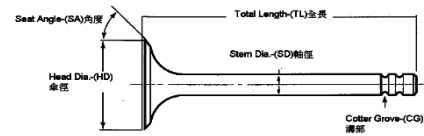

SIZE

STD

Valve Seat

OEM NO. 11098-54T01
IN 44.5 38.0 7.0
OEM NO. 11099-43G00
EX 39.5 33.0 8.0

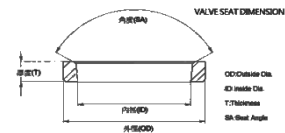

SIZE

STD

Valve Guide

OEM NO. 13212-43G01
IN/EX 47.0 8.0 12.0

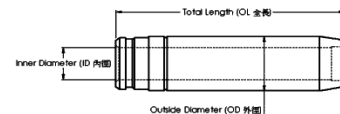

SIZE

STD

Gasket Set

OEM NO.



NISSAN CD20T

Application :
Number of Cylinders 4
Cylinder dia.84.5 MM
Swept Volume 1973 ccm

Piston kit-Set

OEM NO. A2010-2J600



Piston

SIZE

Comp : 44.5 w/al-fin Height : -1.4 oil-cooled Length : 75.7
 Top Shape : flower
 Head Anodized
 Pin : 28.0 Length : 66.5

STD

Piston Ring

OEM NO.

NPR :



OEM Ring Groove

SIZE

Top : 2.0HK
 2nd : 2.0
 Oil : 3.0

STD

Cylinder Liner

OEM NO.



Liner&Sleeve

SIZE

In Diameter :
 Out Diameter :
 Total length :
 Flange :

STD

Engine Bearing

MAIN : 12207-D0200
 CON.ROD : 12111-22J00
 T/W :
 C/B :
 BUSH : 12030-57J00

SIZE



STD

Engine Valve

OEM NO. 13201-60J02
 IN 39.0 7.0 98.8
 OEM NO. 13202-60J02
 EX 32.0 7.0 99.6

SIZE

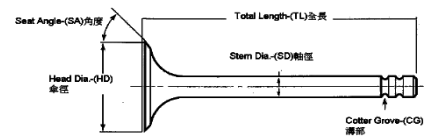

STD

Valve Seat

OEM NO.
 IN
 OEM NO.
 EX

SIZE

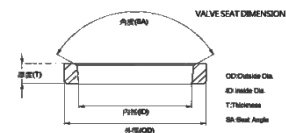

STD

Valve Guide

OEM NO. 13212-FY500
 IN 45.2 7.0 11.0
 OEM NO. 13212-D0111
 EX 48.0 7.0 11.0

SIZE

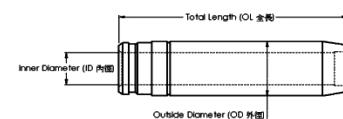

STD

Gasket Set

OEM NO.



NISSAN ED30

Application : TRUCK
Number of Cylinders 4
Cylinder dia.98.0 MM
Swept Volume 2956 ccm

Piston kit-Set

OEM NO. 12010-J2000

Piston

SIZE

Comp : 59.0 w/al-fin Height : -2.0 Length : 103.0
Top Shape : flower
Pin : 32.0 Length :

STD



Piston Ring

OEM NO. 12033-J2002

NPR : SDN31-015ZZ

OEM Ring Groove

SIZE

Top : 3.0
2nd : 2.0
3rd : 2.0
Oil : 4.5

STD



Cylinder Liner

OEM NO. 11012-J20001

Liner&Sleeve

SIZE

In Diameter : 98.0
Out Diameter : 111.0
Total length : 184.5
Flange : 117.0*5.0+1.0

STD



Engine Bearing

MAIN : 12207-J2000
CON.ROD : 12117-J2000
T/W : 12280-J2025
C/B : 13002-J2000
BUSH : 12030-J2000

SIZE

STD



Engine Valve

OEM NO. 13201-J2000/1
IN 45.0 9.0 129.7
OEM NO. 13202-J2000/1
EX 36.0 9.0 130.0

SIZE

STD

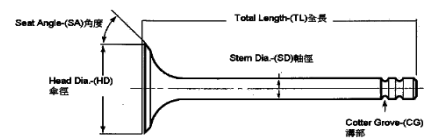

Valve Seat

OEM NO. 13214-J2001
IN 48.0 40.0 6.2
OEM NO. 13215-J2001
EX 39.0 32.0 7.0

SIZE

STD

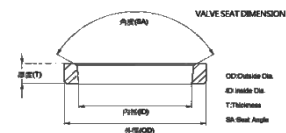

Valve Guide

OEM NO. 13211-Z5001
IN/EX 60.0 9.0 14.0

SIZE

STD

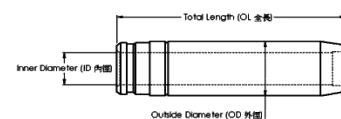

Gasket Set

OEM NO.



NISSAN ED33

Application : TRUCK
Number of Cylinders 4
Cylinder dia.100.0 MM
Swept Volume 3298 ccm

Piston kit-Set

OEM NO. 12010-T9020

Piston	SIZE
Comp : 59.0 Height : -1.9 Length : 103.0 Top Shape : flower Pin : 34.0 Length : 84.0	STD

Piston Ring

OEM NO. 12033-J6500
NPR : SDN31-025ZZ

OEM Ring Groove	SIZE
Top : 3.0 2nd : 2.0 Oil : 4.5	STD



Cylinder Liner

OEM NO. 11012-J20001

Liner&Sleeve	SIZE
In Diameter : 98.0 Out Diameter : 111.0 Total length : 184.5 Flange : 117.0*5.0+1.0	STD



Engine Bearing

MAIN : 12207-J6500
CON.ROD : 12117-01T00
T/W : 12280-J2025
C/B : 13002-T9000
BUSH : 12030-Z5000

SIZE
STD



Engine Valve

OEM NO. 13201-Z5000
IN 47.0 9.0 130.0
OEM NO. 13202-J2000
EX 38.0 9.0 130.0

SIZE
STD

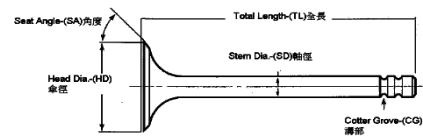

Valve Seat

OEM NO. 13214-Z5000
IN 50.0 42.0 6.5
OEM NO. 13215-Z5000
EX 41.0 34.0 7.3

SIZE
STD

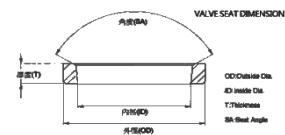

Valve Guide

OEM NO. 13211-Z5001
IN/EX 60.0 9.0 14.0

SIZE
STD

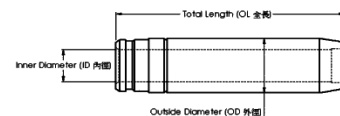

Gasket Set

OEM NO.



NISSAN ED33

Application : TRUCK
Number of Cylinders 4
Cylinder dia.98.0 MM
Swept Volume 3298 ccm

Piston kit-Set

OEM NO. 12010-J6500

Piston

SIZE

Comp : 59.0 w/al-fin Height : -2.6 Length : 103.0
Top Shape : flower
Pin : 34.0 Length : 84.0

STD



Piston Ring

OEM NO. 12033-J6500

NPR : SDN31-025ZZ

OEM Ring Groove

SIZE

Top : 3.0
2nd : 2.0
Oil : 4.5

STD



Cylinder Liner

OEM NO. 11012-J20001

Liner&Sleeve

SIZE

In Diameter : 98.0
Out Diameter : 111.0
Total length : 184.5
Flange : 117.0*5.0+1.0

STD



Engine Bearing

MAIN : 12207-J6500

CON.ROD : 12117-01T00

T/W : 12280-J2025

C/B : 13002-T9000

BUSH : 12030-Z5000

SIZE

STD



Engine Valve

OEM NO. 13201-Z5000

IN 47.0 9.0 130.0

OEM NO. 13202-Z5000

EX 38.0 9.0 130.0

SIZE

STD

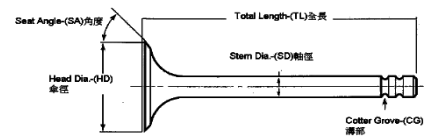

Valve Seat

OEM NO. 13214-Z5000

IN 50.0 42.0 6.5

OEM NO. 13215-Z5000

EX 41.0 34.0 7.3

SIZE

STD

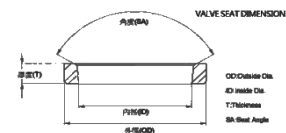

Valve Guide

OEM NO. 13211-Z5001

IN/EX 60.0 9.0 14.0

SIZE

STD

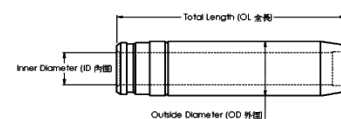

Gasket Set

OEM NO.



NISSAN ED33

Application : TRUCK
Number of Cylinders 4
Cylinder dia.102.5 MM
Swept Volume 3465 ccm

Piston kit-Set

OEM NO. 12010-56T12

Piston	SIZE
Comp : 59.0 w/al-fin Height : -4.0 Length : 98.0 Top Shape : flower Pin : 34.0 Length : 84.0	STD

Piston Ring

OEM NO. 12033-56T10
NPR : SDN31-025ZZ

OEM Ring Groove	SIZE
Top : 3.0 2nd : 2.0 Oil : 4.0	STD



Cylinder Liner

OEM NO. 11012-01T10

Liner&Sleeve	SIZE
In Diameter : 102.5 Out Diameter : 113.2 Total length : 191.0 Flange : 119.2*8.0+1.0	STD



Engine Bearing

MAIN : 12207-J6500
CON.ROD : 12117-01T00
T/W : 12280-J2025
C/B : 13002-T9000
BUSH : 12030-Z5000

SIZE
STD



Engine Valve

OEM NO.
IN
OEM NO.
EX

SIZE
STD

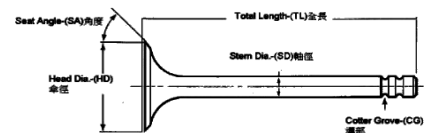

Valve Seat

OEM NO.
IN
OEM NO.
EX

SIZE
STD

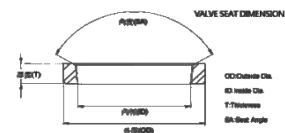

Valve Guide

OEM NO.
IN
OEM NO.
EX

SIZE
STD

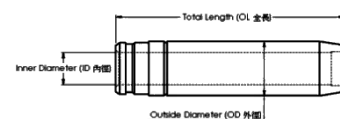

Gasket Set

OEM NO.



NISSAN FD6

Application : TRUCK
Number of Cylinders 4
Cylinder dia.100.0 MM
Swept Volume 5654 ccm

Piston kit-Set

OEM NO. 12011-Z5576

Piston	SIZE
Comp : 65.5 w/al-fin Height : -19.0 Length : 109.5 Top Shape : Ø56.0 Direct Injection Pin : 34.0 Length : 85.0	STD



Piston Ring

OEM NO. 12040-Z5028
NPR : SDN31-029ZZ

OEM Ring Groove	SIZE
Top : 3.0 2nd : 2.0 Oil : 4.5	STD



Cylinder Liner

OEM NO. 11012-Z50001

Liner&Sleeve	SIZE
In Diameter : 100.0 Out Diameter : 112.0 Total length : 212.0 Flange : 118.0*8.0+1.0	STD



Engine Bearing

MAIN : 12207-Z5325
CON.ROD : 12117-Z5510
T/W : 12280-J2025
C/B : 13003-Z5025
BUSH : 12030-Z5000

SIZE
STD



Engine Valve

OEM NO. 13201-Z5000
IN 47.0 9.0 130.0
OEM NO. 13202-Z5000
EX 38.0 9.0 130.0

SIZE
STD

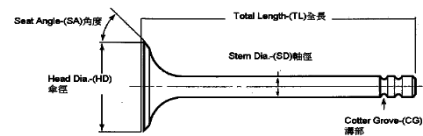

Valve Seat

OEM NO. 13214-Z5000
IN 50.0 42.0 6.5
OEM NO. 13215-Z5000
EX 41.0 34.0 7.3

SIZE
STD

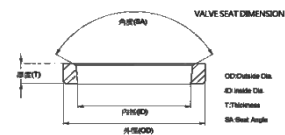

Valve Guide

OEM NO. 13211-Z50001
IN/EX 60.0 9.0 14.0

SIZE
STD

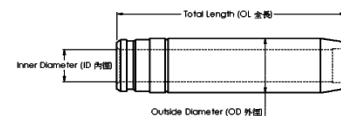

Gasket Set

OEM NO.



NISSAN

FD6-4G

Application : TRUCK
Number of Cylinders 6
Cylinder dia.100.0 MM
Swept Volume 5654 ccm

Piston kit-Set

OEM NO. 12011-Z5505

Piston	SIZE
Comp : 65.5 w/al-fin Height : -20.1 Length : 109.5 Top Shape : Direct Injection Pin : 34.0 Length : 85.0	STD

Piston Ring

OEM NO. 12040-Z5025
 NPR : SDN31-016ZZ

OEM Ring Groove	SIZE
Top : 3.0 2nd : 2.0 3nd : 2.0 Oil : 4.5	STD



Cylinder Liner

OEM NO. 11012-Z50001

Liner&Sleeve	SIZE
In Diameter : 100.0 Out Diameter : 112.0 Total length : 212.0 Flange : 118.0*8.0+1.0	STD



Engine Bearing

MAIN : 12207-Z5325
 CON.ROD : 12117-Z5510
 T/W : 12280-J2025
 C/B : 13003-Z5025
 BUSH : 12030-Z5000

SIZE
 STD



Engine Valve

OEM NO. 13201-Z5000
 IN 47.0 9.0 130.0
 OEM NO. 13202-Z5000
 EX 38.0 9.0 130.0

SIZE
 STD

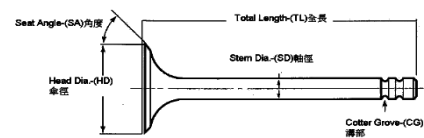

Valve Seat

OEM NO. 13214-Z5000
 IN 50.0 42.0 6.5
 OEM NO. 13215-Z5000
 EX 41.0 34.0 7.3

SIZE
 STD

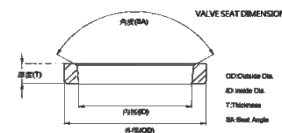

Valve Guide

OEM NO. 13211-Z50001
 IN/EX 60.0 9.0 14.0

SIZE
 STD

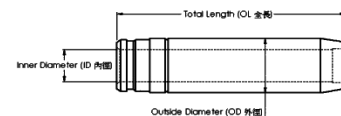

Gasket Set

OEM NO.



NISSAN FD6T-3G

Application : TRUCK
Number of Cylinders 6
Cylinder dia.100.0 MM
Swept Volume 5654 ccm

Piston kit-Set

OEM NO. 12011-Z5572

Piston	SIZE
Comp : 65.6 w/al-fin Height : -22.5 Length : 109.5 Top Shape : Ø55.0 Direct Injection Pin : 34.0 Length : 85.0	STD



Piston Ring

OEM NO. 12033-Z5528
NPR : SDN31-026ZZ

OEM Ring Groove	SIZE
Top : 3.0K 2nd : 2.0 Oil : 4.5	STD



Cylinder Liner

OEM NO. 11012-Z50001

Liner&Sleeve	SIZE
In Diameter : 100.0 Out Diameter : 112.0 Total length : 212.0 Flange : 118.0*8.0+1.0	STD



Engine Bearing

MAIN : 12207-Z5325
CON.ROD : 12117-Z5510
T/W : 12280-J2025
C/B : 13003-Z5025
BUSH : 12030-Z5000

SIZE
STD



Engine Valve

OEM NO. 13201-Z5000
IN 47.0 9.0 130.0
OEM NO. 13202-Z5000
EX 38.0 9.0 130.0

SIZE
STD

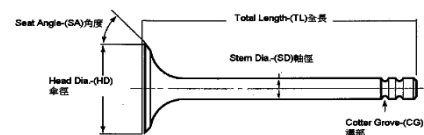

Valve Seat

OEM NO. 13214-Z5000
IN 50.0 42.0 6.5
OEM NO. 13215-Z5000
EX 41.0 34.0 7.3

SIZE
STD

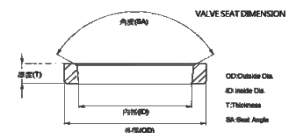

Valve Guide

OEM NO. 13211-Z50001
IN/EX 60.0 9.0 14.0

SIZE
STD

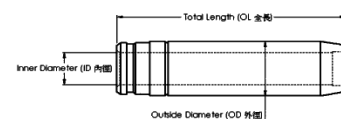

Gasket Set

OEM NO.



NISSAN FD6T-3G

Application : TRUCK
Number of Cylinders 6
Cylinder dia.100.0 MM
Swept Volume 5654 ccm

Piston kit-Set

OEM NO. 12011-Z5600

Piston	SIZE
Comp : 65.5 w/al-fin Height : -18.5 Length : 109.5 Top Shape : Ø55.0 Direct Injection Pin : 34.0 Length : 85.0	STD

Piston Ring

OEM NO. 12033-Z5528
NPR : SDN31-026ZZ

OEM Ring Groove	SIZE
Top : 3.0K 2nd : 2.0 Oil : 4.5	STD



Cylinder Liner

OEM NO. 11012-Z50001

Liner&Sleeve	SIZE
In Diameter : 100.0 Out Diameter : 112.0 Total length : 212.0 Flange : 118.0*8.0+1.0	STD



Engine Bearing

MAIN : 12207-Z5325
CON.ROD : 12117-Z5510
T/W : 12280-J2025
C/B : 13003-Z5025
BUSH : 12030-Z5000

SIZE
STD



Engine Valve

OEM NO. 13201-Z5000
IN 47.0 9.0 130.0
OEM NO. 13202-Z5000
EX 38.0 9.0 130.0

SIZE
STD

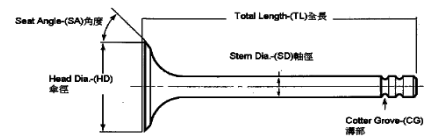

Valve Seat

OEM NO. 13214-Z5000
IN 50.0 42.0 6.5
OEM NO. 13215-Z5000
EX 41.0 34.0 7.3

SIZE
STD

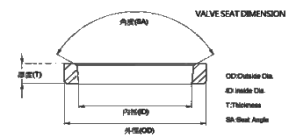

Valve Guide

OEM NO. 13211-Z50001
IN/EX 60.0 9.0 14.0

SIZE
STD

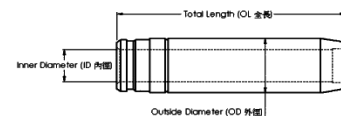

Gasket Set

OEM NO.



NISSAN FD6T-4G

Application : TRUCK
Number of Cylinders 6
Cylinder dia.100.0 MM
Swept Volume 5654 ccm

Piston kit-Set

OEM NO. 12011-Z5509

Piston	SIZE
Comp : 65.6 w/al-fin Height : -21.7 Length : 107.0 Top Shape : Ø55.0 Direct Injection Pin : 34.0 Length : 85.0	STD



Piston Ring

OEM NO. 12033-Z5527
 NPR : SDN31-021ZZ

OEM Ring Groove	SIZE
Top : 3.0K 2nd : 2.0 3rd : 2.0 Oil : 4.5	STD



Cylinder Liner

OEM NO. 11012-Z50001

Liner&Sleeve	SIZE
In Diameter : 100.0 Out Diameter : 112.0 Total length : 212.0 Flange : 118.0*8.0+1.0	STD



Engine Bearing

MAIN : 12207-Z5325
 CON.ROD : 12117-Z5510
 T/W : 12280-J2025
 C/B : 13003-Z5025
 BUSH : 12030-Z5000

SIZE
 STD



Engine Valve

OEM NO. 13201-Z5000
 IN 47.0 9.0 130.0
 OEM NO. 13202-Z5000
 EX 38.0 9.0 130.0

SIZE
 STD

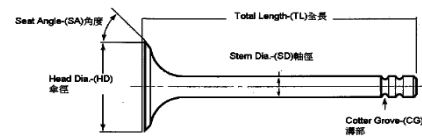

Valve Seat

OEM NO. 13214-Z5000
 IN 50.0 42.0 6.5
 OEM NO. 13215-Z5000
 EX 41.0 34.0 7.3

SIZE
 STD

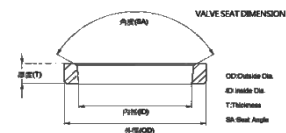

Valve Guide

OEM NO. 13211-Z50001
 IN/EX 60.0 9.0 14.0

SIZE
 STD

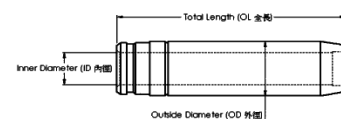

Gasket Set

OEM NO.



NISSAN FD33

Application : TRUCK
Number of Cylinders 4
Cylinder dia.100.0 MM
Swept Volume 3298 ccm

Piston kit-Set

OEM NO. 12011-T9313

Piston	SIZE
Comp : 59.2 w/al-fin Height : -20.9 Length : 103.2 Top Shape : Ø47.5 Direct Injection Pin : 34.0 Length : 85.0	STD



Piston Ring

OEM NO. 12033-J6500
NPR : SDN31-025ZZ

OEM Ring Groove	SIZE
Top : 3.0 2nd : 2.0 Oil : 4.5	STD



Cylinder Liner

OEM NO. 11012-T9017

Liner&Sleeve	SIZE
In Diameter : 100.0 Out Diameter : 113.2 Total length : 191.0 Flange : 119.2*8.0+1.0	STD



Engine Bearing

MAIN : 12207-J6500
CON.ROD : 12117-01T00
T/W : 12280-J2025
C/B : 13003-T9000
BUSH : 12030-Z5000

SIZE
STD



Engine Valve

OEM NO. 13201-T9300
IN 47.0 9.0 129.6
OEM NO. 13202-Z5000
EX 38.0 9.0 130.0

SIZE
STD

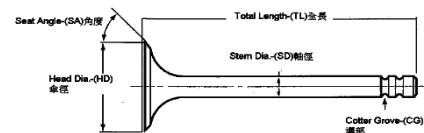

Valve Seat

OEM NO. 13214-Z5000
IN 50.0 42.0 6.5
OEM NO. 13215-Z5000
EX 41.0 34.0 7.3

SIZE
STD

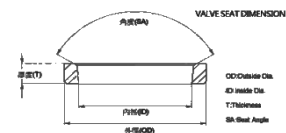

Valve Guide

OEM NO. 13211-Z50001
IN/EX 60.0 9.0 14.0

SIZE
STD

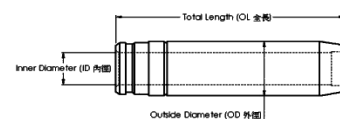

Gasket Set

OEM NO.



NISSAN FD33T

Application : TRUCK
Number of Cylinders 4
Cylinder dia.100.0 MM
Swept Volume 3298 ccm

Piston kit-Set

OEM NO. 12010-T9300

Piston	SIZE
Comp : 59.5 w/al-fin Height : -20.9 Length : 98.5 Top Shape : Ø48.0 Direct Injection Pin : 34.0 Length : 85.0	STD

Piston Ring

OEM NO. 12033-J9302
NPR : SDN31-025ZZ

OEM Ring Groove	SIZE
Top : 3.0K 2nd : 2.0 Oil : 4.5	STD



Cylinder Liner

OEM NO. 11012-T9017

Liner&Sleeve	SIZE
In Diameter : 100.0 Out Diameter : 113.2 Total length : 191.0 Flange : 119.2*8.0+1.0	STD



Engine Bearing

MAIN : 12207-J6500
CON.ROD : 12117-01T00
T/W : 12280-J2025
C/B : 13003-T9000
BUSH : 12030-Z5000

SIZE
STD



Engine Valve

OEM NO. 13201-T9300
IN 47.0 9.0 129.6
OEM NO. 13202-Z5000
EX 38.0 9.0 130.0

SIZE
STD

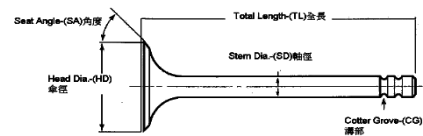

Valve Seat

OEM NO. 13214-Z5000
IN 50.0 42.0 6.5
OEM NO. 13215-Z5000
EX 41.0 34.0 7.3

SIZE
STD

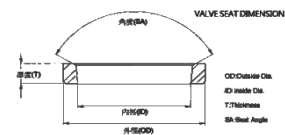

Valve Guide

OEM NO. 13211-Z50001
IN/EX 60.0 9.0 14.0

SIZE
STD

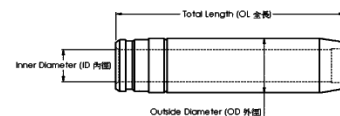

Gasket Set

OEM NO.



NISSAN

FD35

Application : TRUCK
Number of Cylinders 4
Cylinder dia.102.5 MM
Swept Volume 3465 ccm

Piston kit-Set

OEM NO. 12011-01T04

Piston

SIZE

Comp : 59.3 w/al-fin Height : -17.0 Length : 98.2
 Top Shape : Ø42.3
 Direct Injection
 Pin : 34.0 Length : 85.0

STD



Piston Ring

OEM NO. 12033-01T10

NPR : SDN31-045ZX

OEM Ring Groove

SIZE

Top : 2.0
 2nd : 2.0
 Oil : 4.0

STD



Cylinder Liner

OEM NO. 11012-01T10

Liner&Sleeve

SIZE

In Diameter : 102.5
 Out Diameter : 113.2
 Total length : 191.0
 Flange : 119.2*8.0+1.0

STD



Engine Bearing

MAIN : 12207-J6500
 CON.ROD : 12117-01T00
 T/W : 12280-J2025
 C/B : 13003-T9000
 BUSH : 12030-Z5000

SIZE

STD



Engine Valve

OEM NO. 13201-01T00
 IN 48.5 9.0 130.5
 OEM NO. 13202-01T00
 EX 39.8 9.0 130.5

SIZE

STD

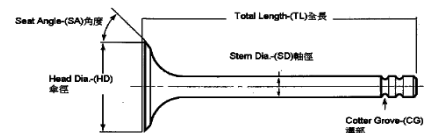

Valve Seat

OEM NO. 13214-Z5500
 IN 50.0 42.0 7.5
 OEM NO. 13215-Z5500
 EX 41.0 34.0 7.5

SIZE

STD

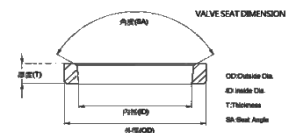

Valve Guide

OEM NO. 13211-Z50001
 IN/EX 60.0 9.0 14.0

SIZE

STD

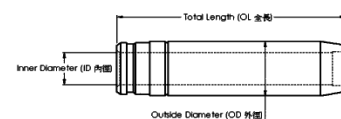

Gasket Set

OEM NO.



NISSAN

FD35

Application : TRUCK
Number of Cylinders 4
Cylinder dia.102.5 MM
Swept Volume 3465 ccm

Piston kit-Set

OEM NO. 12011-01T14

Piston

SIZE

Comp : 59.2 w/al-fin Height : -17.0 Length : 98.3
 Top Shape : Ø55.0
 Direct Injection
 Pin : 34.0 Length : 85.0

STD

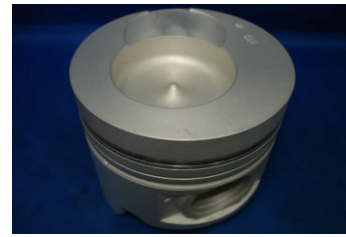

Piston Ring

OEM NO. 12033-01T10

NPR : SDN31-045ZX

OEM Ring Groove

SIZE

Top : 2.0
 2nd : 2.0
 Oil : 4.0

STD



Cylinder Liner

OEM NO. 11012-01T10

Liner&Sleeve

SIZE

In Diameter : 102.5
 Out Diameter : 113.2
 Total length : 191.0
 Flange : 119.2*8.0+1.0

STD



Engine Bearing

MAIN : 12207-J6500
 CON.ROD : 12117-01T00
 T/W : 12280-J2025
 C/B : 13003-T9000
 BUSH : 12030-Z5000

SIZE

STD



Engine Valve

OEM NO. 13201-01T00
 IN 48.5 9.0 130.5
 OEM NO. 13202-01T00
 EX 39.8 9.0 130.5

SIZE

STD

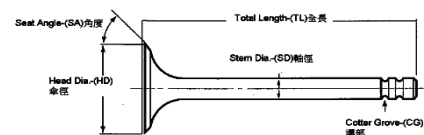

Valve Seat

OEM NO. 13214-Z5500
 IN 50.0 42.0 7.5
 OEM NO. 13215-Z5500
 EX 41.0 34.0 7.5

SIZE

STD

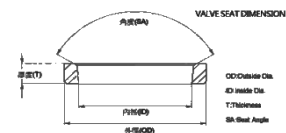

Valve Guide

OEM NO. 13211-Z50001
 IN/EX 60.0 9.0 14.0

SIZE

STD

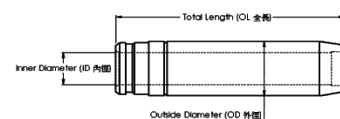

Gasket Set

OEM NO.



Piston kit-Set

OEM NO. 12011-01T03

Piston	SIZE
Comp : 59.3 w/al-fin Height : -17.4 Length : 98.2 Top Shape : Ø Direct Injection Pin : 34.0 Length : 85.0	STD



Piston Ring

OEM NO. 12033-01T60
NPR : SDN31-057ZZ

OEM Ring Groove	SIZE
Top : 3.0K 2nd : 2.0 Oil : 4.0	STD



Cylinder Liner

OEM NO. 11012-01T10

Liner&Sleeve	SIZE
In Diameter : 102.5 Out Diameter : 113.2 Total length : 191.0 Flange : 119.2*8.0+1.0	STD



Engine Bearing

MAIN : 12207-J6500
CON.ROD : 12117-01T00
T/W : 12280-J2025
C/B : 13003-T9000
BUSH : 12030-Z5000

SIZE
STD



Engine Valve

OEM NO. 13201-01T00
IN 48.5 9.0 130.5
OEM NO. 13202-01T00
EX 39.8 9.0 130.5

SIZE
STD

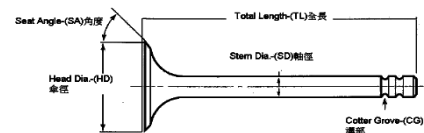

Valve Seat

OEM NO. 13214-Z5500
IN 50.0 42.0 7.5
OEM NO. 13215-Z5500
EX 41.0 34.0 7.5

SIZE
STD

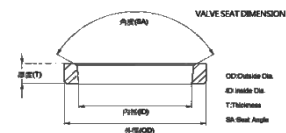

Valve Guide

OEM NO. 13211-Z50001
IN/EX 60.0 9.0 14.0

SIZE
STD

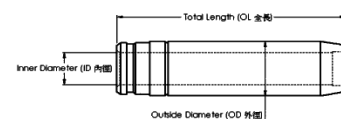

Gasket Set

OEM NO.



NISSAN FD42

Application : TRUCK
Number of Cylinders 4
Cylinder dia.108.0 MM
Swept Volume 4214 ccm

Piston kit-Set

OEM NO. 12010-0T015

Piston	SIZE
Comp : 59.0 w/al-fin Height : oil-cooled Length : 87.0 Top Shape : Ø53.0 Direct Injection Pin : 36.0 Length : 93.0	STD

Piston Ring

OEM NO. 12033-0T010
NPR : SDN31-064ZZ

OEM Ring Groove	SIZE
Top : 3.0 2nd : 2.0 Oil : 4.0	STD



Cylinder Liner

OEM NO. 11012-0T001

Liner&Sleeve	SIZE
In Diameter : 108.0 Out Diameter : 111.0 Total length : 198.0 Flange : 116.0*8.0+1.0	STD



Engine Bearing

MAIN : 12207-0T003
CON.ROD : 12111-0T003
T/W : 12280-Z5225
C/B : 13005-0T000
BUSH : 12030-0T001

SIZE
STD



Engine Valve

OEM NO.
IN
OEM NO.
EX

SIZE
STD

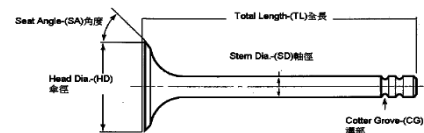

Valve Seat

OEM NO.
IN
OEM NO.
EX

SIZE
STD

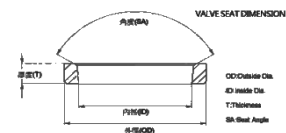

Valve Guide

OEM NO.
IN
OEM NO.
EX

SIZE
STD

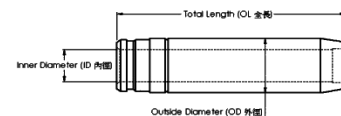

Gasket Set

OEM NO.



NISSAN FD42

Application : TRUCK
Number of Cylinders 4
Cylinder dia.108.0 MM
Swept Volume 4214 ccm

Piston kit-Set

OEM NO. 12010-0T016



Piston

SIZE

Comp : 59.4 w/al-fin Height : -21.3 Length : 87.0
Top Shape : Ø53.0
Direct Injection
Pin : 36.0 Length : 93.0

STD

Piston Ring

OEM NO. 12033-0T010

NPR : SDN31-064ZZ



OEM Ring Groove

SIZE

Top : 3.0
2nd : 2.0
Oil : 4.0

STD

Cylinder Liner

OEM NO. 11012-0T001



Liner&Sleeve

SIZE

In Diameter : 108.0
Out Diameter : 111.0
Total length : 198.0
Flange : 116.0*8.0+1.0

STD

Engine Bearing

MAIN : 12207-0T003

CON.ROD : 12111-0T003

T/W : 12280-Z5225

C/B : 13005-0T000

BUSH : 12030-0T001

SIZE



STD

Engine Valve

OEM NO.

IN

OEM NO.

EX

SIZE

STD

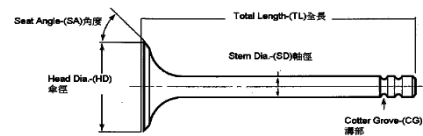

Valve Seat

OEM NO.

IN

OEM NO.

EX

SIZE

STD

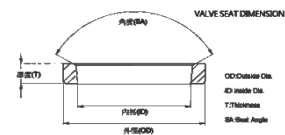

Valve Guide

OEM NO.

IN

OEM NO.

EX

SIZE

STD

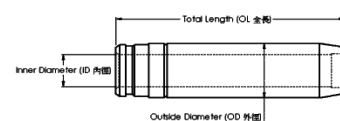

Gasket Set

OEM NO.



Piston kit-Set

OEM NO. 12010-0T302

Piston	SIZE
Comp : 58.2 w/al-fin Height : Length : 87.1 Top Shape : Ø Direct Injection Pin : 36.0 Length : 93.0	STD

Piston Ring

OEM NO. 12033-0T010
NPR : SDN31-064ZZ

OEM Ring Groove	SIZE
Top : 3.0 2nd : 2.0 Oil : 4.0	STD



Cylinder Liner

OEM NO. 11012-03T001

Liner&Sleeve	SIZE
In Diameter : 108.0 Out Diameter : 111.0 Total length : 215.0 Flange : 116.0*8.0+1.0	STD



Engine Bearing

MAIN : 12207-0T003
CON.ROD : 12111-0T003
T/W : 12280-Z5225
C/B : 13005-0T000
BUSH : 12030-0T001

SIZE
STD



Engine Valve

OEM NO. 13201-0T000
IN 48.5 9.0 129.5
OEM NO. 13202-17D00/13202-01T00
EX 39.8 9.0 130.0

SIZE
STD

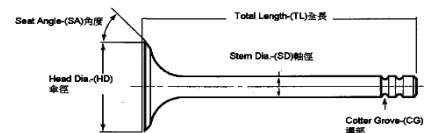

Valve Seat

OEM NO. 13214-Z5500
IN 50.0 42.0 7.5
OEM NO. 13215-Z5500
EX 41.0 32.0 7.5

SIZE
STD

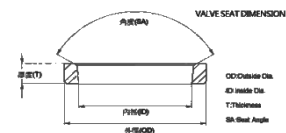

Valve Guide

OEM NO. 13211-Z50001
IN/EX 60.0 9.0 14.0

SIZE
STD

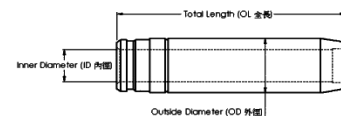

Gasket Set

OEM NO.



NISSAN

FD46

Application : TRUCK
Number of Cylinders 4
Cylinder dia.108.0 MM
Swept Volume 4617 ccm

Piston kit-Set

OEM NO. 12010-0T312

Piston	SIZE
Comp : 59.3 w/al-fin Height : -21.5 Length : 87.1 Top Shape : Ø53.0 Direct Injection Pin : 36.0 Length : 93.0	STD

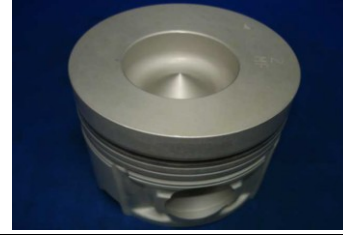

Piston Ring

OEM NO. 12033-0T010
 NPR : SDN31-064ZZ

OEM Ring Groove	SIZE
Top : 3.0 2nd : 2.0 Oil : 4.0	STD



Cylinder Liner

OEM NO. 11012-03T001

Liner&Sleeve	SIZE
In Diameter : 108.0 Out Diameter : 111.0 Total length : 215.0 Flange : 116.0*8.0+1.0	STD



Engine Bearing

MAIN : 12207-0T003
 CON.ROD : 12111-0T003
 T/W : 12280-Z5225
 C/B : 13005-0T000
 BUSH : 12030-0T001

SIZE
 STD



Engine Valve

OEM NO. 13201-0T000
 IN 48.5 9.0 129.5
 OEM NO. 13202-17D00
 EX 39.8 9.0 130.0

SIZE
 STD

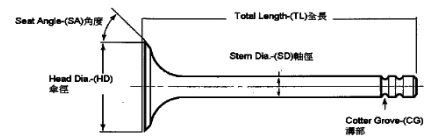

Valve Seat

OEM NO. 13214-Z5500
 IN 50.0 42.0 7.5
 OEM NO. 13215-Z5500
 EX 41.0 32.0 7.5

SIZE
 STD

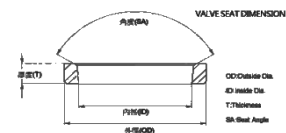

Valve Guide

OEM NO. 13211-Z50001
 IN/EX 60.0 9.0 14.0

SIZE
 STD

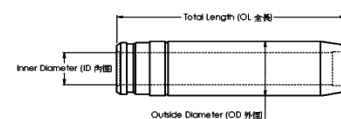

Gasket Set

OEM NO.



NISSAN

FD46T

Application : TRUCK
Number of Cylinders 4
Cylinder dia.108.0 MM
Swept Volume 4617 ccm

Piston kit-Set

OEM NO. 12010-0T311

Piston	SIZE
Comp : 59.2 w/al-fin Height : -22.1 oil-cooled Length : 87.1 Top Shape : Ø55.4 Direct Injection Pin : 36.0 Length : 93.0	STD



Piston Ring

OEM NO. 12033-0T010
 NPR : SDN31-064ZZ

OEM Ring Groove	SIZE
Top : 3.0 2nd : 2.0 Oil : 4.0	STD



Cylinder Liner

OEM NO. 11012-03T001

Liner&Sleeve	SIZE
In Diameter : 108.0 Out Diameter : 111.0 Total length : 215.0 Flange : 116.0*8.0+1.0	STD



Engine Bearing

MAIN : 12207-0T003
 CON.ROD : 12111-0T003
 T/W : 12280-Z5225
 C/B : 13005-0T000
 BUSH : 12030-0T001

SIZE
 STD



Engine Valve

OEM NO. 13201-0T000
 IN 48.5 9.0 129.5
 OEM NO. 13202-17D00
 EX 39.8 9.0 130.0

SIZE
 STD

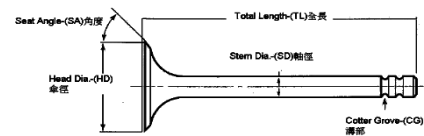

Valve Seat

OEM NO. 13214-Z5500
 IN 50.0 42.0 7.5
 OEM NO. 13215-Z5500
 EX 41.0 32.0 7.5

SIZE
 STD

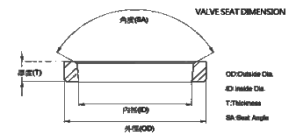

Valve Guide

OEM NO. 13211-Z50001
 IN/EX 60.0 9.0 14.0

SIZE
 STD

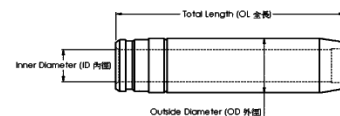

Gasket Set

OEM NO.



NISSAN FD46T

Application : TRUCK
Number of Cylinders 4
Cylinder dia.108.0 MM
Swept Volume 4617 ccm

Piston kit-Set

OEM NO. 12010-19D00

Piston

SIZE

Comp : 59.2 w/al-fin Height : -22.1 oil-cooled Length : 87.1
Top Shape : Ø55.0
Direct Injection Head Anodized
Pin : 36.0 Length : 93.0

STD



Piston Ring

OEM NO. 12033-31D03

NPR : SDN30-171ZZ

OEM Ring Groove

SIZE

Top : 2.5K
2nd : 2.0
Oil : 4.0

STD



Cylinder Liner

OEM NO. 11012-03T001

Liner&Sleeve

SIZE

In Diameter : 108.0
Out Diameter : 111.0
Total length : 215.0
Flange : 116.0*8.0+1.0

STD



Engine Bearing

MAIN : 12207-0T003
CON.ROD : 12111-0T003
T/W : 12280-Z5225
C/B : 13005-0T000
BUSH : 12030-0T001

SIZE

STD



Engine Valve

OEM NO. 13201-0T000
IN 48.5 9.0 129.5
OEM NO. 13202-17D00/13202-01T00
EX 39.8 9.0 130.0

SIZE

STD

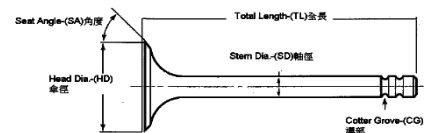

Valve Seat

OEM NO. 13214-Z5500
IN 50.0 42.0 7.5
OEM NO. 13215-Z5500
EX 41.0 32.0 7.5

SIZE

STD

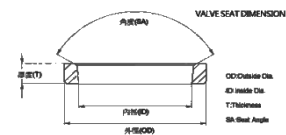

Valve Guide

OEM NO. 13211-Z50001
IN/EX 60.0 9.0 14.0

SIZE

STD

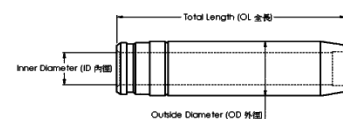

Gasket Set

OEM NO.



Piston kit-Set

OEM NO. 12010-Z5618

Piston	SIZE
Comp : 65.4 w/al-fin Height : -19.4 Length : 103.4 Top Shape : Ø59.0 Direct Injection Pin : 36.0 Length : 92.0	STD

Piston Ring

OEM NO. 12040-Z5505
NPR : SDN30-036ZZ

OEM Ring Groove	SIZE
Top : 3.0K 2nd : 2.0 Oil : 4.0	STD



Cylinder Liner

OEM NO. 11012-Z5518

Liner&Sleeve	SIZE
In Diameter : 108.0 Out Diameter : 111.0 Total length : 220.0 Flange : 116.0*8.0+1.0	STD



Engine Bearing

MAIN : 12213-Z5500
CON.ROD : 12117-Z5560
T/W : 12280-Z5225
C/B : 13003-Z5025
BUSH : 12030-95000

SIZE
STD



Engine Valve

OEM NO. 13201-Z5501
IN 48.5 9.0 130.8
OEM NO. 13202-Z5502
EX 39.8 9.0 130.8

SIZE
STD

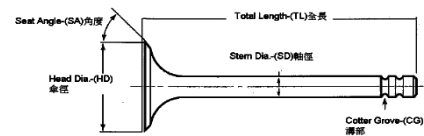

Valve Seat

OEM NO. 13214-Z5500
IN 50.0 42.0 7.5
OEM NO. 13215-Z5500
EX 41.0 32.0 7.5

SIZE
STD

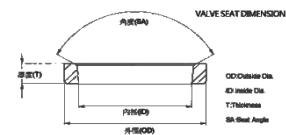

Valve Guide

OEM NO. 13211-Z50001
IN/EX 60.0 9.0 14.0

SIZE
STD

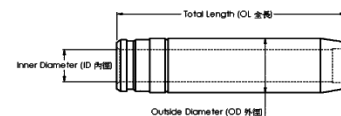

Gasket Set

OEM NO.



NISSAN FE6

Application : TRUCK
Number of Cylinders 6
Cylinder dia.108.0 MM
Swept Volume 6925 ccm

Piston kit-Set

OEM NO. 12011-Z5615

Piston	SIZE
Comp : 65.5 w/al-fin Height : -20.1 Length : 103.4 Top Shape : Ø59.5 Direct Injection Pin : 36.0 Length : 92.0	STD

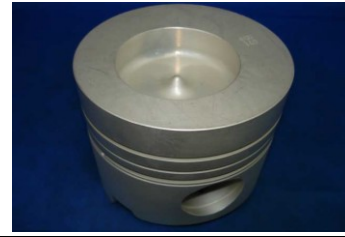

Piston Ring

OEM NO. 12040-Z5504
NPR : SDN30-036ZZ

OEM Ring Groove	SIZE
Top : 3.0 2nd : 2.0 Oil : 4.0	STD



Cylinder Liner

OEM NO. 11012-Z5518

Liner&Sleeve	SIZE
In Diameter : 108.0 Out Diameter : 111.0 Total length : 220.0 Flange : 116.0*8.0+1.0	STD



Engine Bearing

MAIN : 12213-Z5500
CON.ROD : 12117-Z5560
T/W : 12280-Z5225
C/B : 13003-Z5025
BUSH : 12030-95000

SIZE
STD



Engine Valve

OEM NO. 13201-Z5501
IN 48.5 9.0 130.8
OEM NO. 13202-Z5502
EX 39.8 9.0 130.8

SIZE
STD

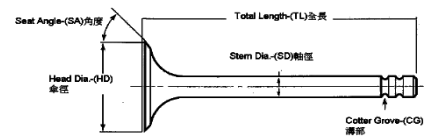

Valve Seat

OEM NO. 13214-Z5500
IN 50.0 42.0 7.5
OEM NO. 13215-Z5500
EX 41.0 32.0 7.5

SIZE
STD

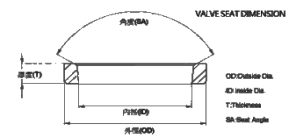

Valve Guide

OEM NO. 13211-Z50001
IN/EX 60.0 9.0 14.0

SIZE
STD

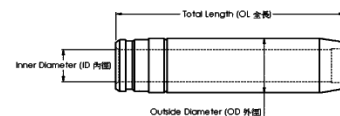

Gasket Set

OEM NO.



NISSAN FE6B

Application : TRUCK
Number of Cylinders 6
Cylinder dia.108.0 MM
Swept Volume 6925 ccm

Piston kit-Set

OEM NO. 12013-Z5572

Piston	SIZE
Comp : 65.6 w/al-fin Height : -22.8 Length : 103.6 Top Shape : Ø56.0 Direct Injection Head Anodized Pin : 36.0 Length : 92.0	STD



Piston Ring

OEM NO. 12040-Z5519
NPR : SDN31-034ZZ

OEM Ring Groove	SIZE
Top : 2.5K 2nd : 2.0 Oil : 4.0	STD



Cylinder Liner

OEM NO. 11012-Z5518

Liner&Sleeve	SIZE
In Diameter : 108.0 Out Diameter : 111.0 Total length : 220.0 Flange : 116.0*8.0+1.0	STD



Engine Bearing

MAIN : 12213-Z5500
CON.ROD : 12117-Z5560
T/W : 12280-Z5225
C/B : 13003-Z5025
BUSH : 12030-95000

SIZE
STD



Engine Valve

OEM NO. 13201-Z5501
IN 48.5 9.0 130.8
OEM NO. 13202-Z5502
EX 39.8 9.0 130.8

SIZE
STD

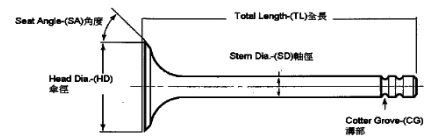

Valve Seat

OEM NO. 13214-Z5500
IN 50.0 42.0 7.5
OEM NO. 13215-Z5500
EX 41.0 32.0 7.5

SIZE
STD

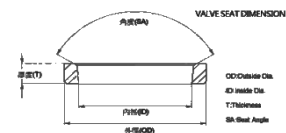

Valve Guide

OEM NO. 13211-Z50001
IN/EX 60.0 9.0 14.0

SIZE
STD

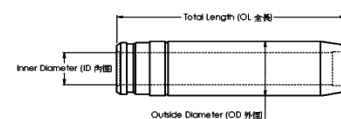

Gasket Set

OEM NO.



NISSAN FE6T

Application : TRUCK 200HP
Number of Cylinders 6
Cylinder dia.108.0 MM
Swept Volume 6925 ccm

Piston kit-Set

OEM NO. 12011-Z5768

Piston	SIZE
Comp : 65.5 w/al-fin Height : -19.5 Length : 103.5 Top Shape : Ø59.4 Direct Injection Head Anodized Pin : 36.0 Length : 90.0	STD



Piston Ring

OEM NO. 12040-Z5505
NPR : SDN31-036ZZ

OEM Ring Groove	SIZE
Top : 3.0K 2nd : 2.0 Oil : 4.0	STD



Cylinder Liner

OEM NO. 11012-Z5518

Liner&Sleeve	SIZE
In Diameter : 108.0 Out Diameter : 111.0 Total length : 220.0 Flange : 116.0*8.0+1.0	STD



Engine Bearing

MAIN : 12213-Z5500
CON.ROD : 12117-Z5560
T/W : 12280-Z5225
C/B : 13003-Z5025
BUSH : 12030-95000

SIZE
STD



Engine Valve

OEM NO. 13201-Z5501
IN 48.5 9.0 130.8
OEM NO. 13202-Z5502
EX 39.8 9.0 130.8

SIZE
STD

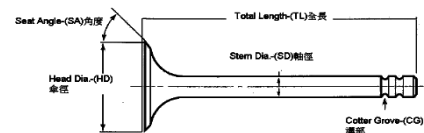

Valve Seat

OEM NO. 13214-Z5500
IN 50.0 42.0 7.5
OEM NO. 13215-Z5500
EX 41.0 32.0 7.5

SIZE
STD

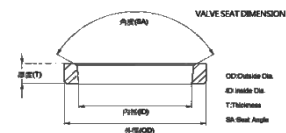

Valve Guide

OEM NO. 13211-Z50001
IN/EX 60.0 9.0 14.0

SIZE
STD

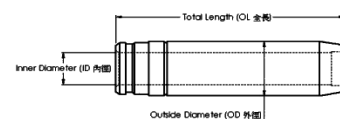

Gasket Set

OEM NO.



NISSAN FE6T

Application : TRUCK 235HP
Number of Cylinders 6
Cylinder dia.108.0 MM
Swept Volume 6925 ccm

Piston kit-Set

OEM NO. 12011-Z5968

Piston	SIZE
Comp : 65.5 w/al-fin Height : -21.4 Length : 103.5 Top Shape : Ø56.0 Direct Injection Head Anodized Pin : 36.0 Length : 90.0	STD



Piston Ring

OEM NO. 12040-Z5519
NPR : SDN31-054ZZ

OEM Ring Groove	SIZE
Top : 2.5K 2nd : 2.0 Oil : 4.0	STD



Cylinder Liner

OEM NO. 11012-Z5518

Liner&Sleeve	SIZE
In Diameter : 108.0 Out Diameter : 111.0 Total length : 220.0 Flange : 116.0*8.0+1.0	STD



Engine Bearing

MAIN : 12213-Z5500
CON.ROD : 12117-Z5560
T/W : 12280-Z5225
C/B : 13003-Z5025
BUSH : 12030-95000

SIZE
STD



Engine Valve

OEM NO. 13201-Z5501
IN 48.5 9.0 130.8
OEM NO. 13202-Z5502
EX 39.8 9.0 130.8

SIZE
STD

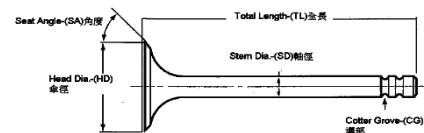

Valve Seat

OEM NO. 13214-Z5500
IN 50.0 42.0 7.5
OEM NO. 13215-Z5500
EX 41.0 32.0 7.5

SIZE
STD

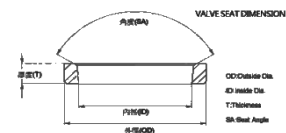

Valve Guide

OEM NO. 13211-Z50001
IN/EX 60.0 9.0 14.0

SIZE
STD

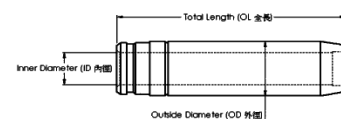

Gasket Set

OEM NO.



NISSAN FE6T

Application : TRUCK
Number of Cylinders 6
Cylinder dia.108.0 MM
Swept Volume 6925 ccm

Piston kit-Set

OEM NO. 12011-Z5702

Piston	SIZE
Comp : 65.5 w/al-fin Height : -19.3 Length : 103.2 Top Shape : Ø60.0 Direct Injection Head Anodized Pin : 36.0 Length : 92.0	STD



Piston Ring

OEM NO. 12040-Z5505
NPR : SDN31-036ZZ

OEM Ring Groove	SIZE
Top : 3.0K 2nd : 2.0 Oil : 4.0	STD



Cylinder Liner

OEM NO. 11012-Z5518

Liner&Sleeve	SIZE
In Diameter : 108.0 Out Diameter : 111.0 Total length : 220.0 Flange : 116.0*8.0+1.0	STD



Engine Bearing

MAIN : 12213-Z5500
CON.ROD : 12117-Z5560
T/W : 12280-Z5225
C/B : 13003-Z5025
BUSH : 12030-95000

SIZE
STD



Engine Valve

OEM NO. 13201-Z5501
IN 48.5 9.0 130.8
OEM NO. 13202-Z5502
EX 39.8 9.0 130.8

SIZE
STD

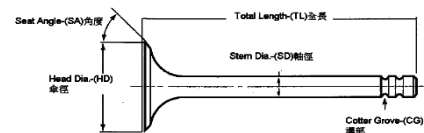

Valve Seat

OEM NO. 13214-Z5500
IN 50.0 42.0 7.5
OEM NO. 13215-Z5500
EX 41.0 32.0 7.5

SIZE
STD

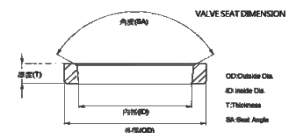

Valve Guide

OEM NO. 13211-Z50001
IN/EX 60.0 9.0 14.0

SIZE
STD

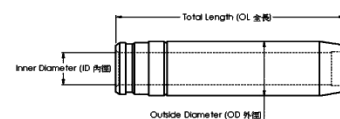

Gasket Set

OEM NO.



NISSAN FE6T

Application : TRUCK 185PS
Number of Cylinders 6
Cylinder dia.108.0 MM
Swept Volume 6925 ccm

Piston kit-Set

OEM NO. 12010-Z5502

Piston	SIZE
Comp : 65.6 w/al-fin Height : -23.1 Length : 103.5 Top Shape : Ø52.5 Direct Injection Pin : 36.0 Length : 90.0	STD

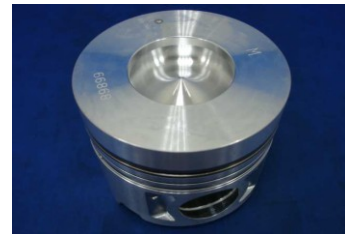

Piston Ring

OEM NO. 12040-Z5505
 NPR : SDN31-036ZZ

OEM Ring Groove	SIZE
Top : 3.0K 2nd : 2.0 Oil : 4.0	STD



Cylinder Liner

OEM NO. 11012-Z5518

Liner&Sleeve	SIZE
In Diameter : 108.0 Out Diameter : 111.0 Total length : 220.0 Flange : 116.0*8.0+1.0	STD



Engine Bearing

MAIN : 12213-Z5500
 CON.ROD : 12117-Z5560
 T/W : 12280-Z5225
 C/B : 13003-Z5025
 BUSH : 12030-95000

SIZE
 STD



Engine Valve

OEM NO. 13201-Z5501
 IN 48.5 9.0 130.8
 OEM NO. 13202-Z5502
 EX 39.8 9.0 130.8

SIZE
 STD

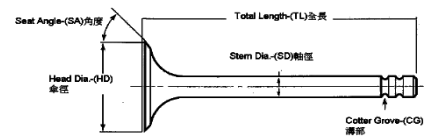

Valve Seat

OEM NO. 13214-Z5500
 IN 50.0 42.0 7.5
 OEM NO. 13215-Z5500
 EX 41.0 32.0 7.5

SIZE
 STD

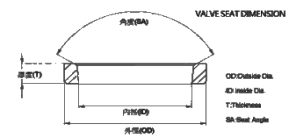

Valve Guide

OEM NO. 13211-Z50001
 IN/EX 60.0 9.0 14.0

SIZE
 STD

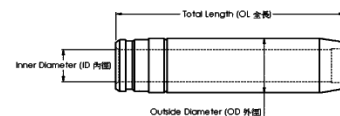

Gasket Set

OEM NO.



NISSAN FE6TA

Application : TRUCK
Number of Cylinders 6
Cylinder dia.108.0 MM
Swept Volume 6925 ccm

Piston kit-Set

OEM NO. 12010-Z5507

Piston	SIZE
Comp : 65.5 w/al-fin Height : -21.2 Length : 103.5 Top Shape : Ø Direct Injection Pin : 36.0 Length : 92.0	STD

Piston Ring

OEM NO. 12040-Z5519
NPR : SDN31-054ZZ

OEM Ring Groove	SIZE
Top : 2.5K 2nd : 2.0 Oil : 4.0	STD



Cylinder Liner

OEM NO. 11012-Z5518

Liner&Sleeve	SIZE
In Diameter : 108.0 Out Diameter : 111.0 Total length : 220.0 Flange : 116.0*8.0+1.0	STD



Engine Bearing

MAIN : 12213-Z5500
CON.ROD : 12117-Z5560
T/W : 12280-Z5225
C/B : 13003-Z5025
BUSH : 12030-95000

SIZE
STD



Engine Valve

OEM NO. 13201-Z5501
IN 48.5 9.0 130.8
OEM NO. 13202-Z5502
EX 39.8 9.0 130.8

SIZE
STD

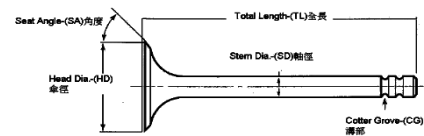

Valve Seat

OEM NO. 13214-Z5500
IN 50.0 42.0 7.5
OEM NO. 13215-Z5500
EX 41.0 32.0 7.5

SIZE
STD

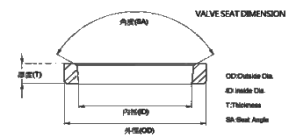

Valve Guide

OEM NO. 13211-Z50001
IN/EX 60.0 9.0 14.0

SIZE
STD

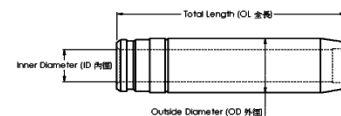

Gasket Set

OEM NO.



NISSAN LD20

Application : VAN
Number of Cylinders 4
Cylinder dia.85.0 MM
Swept Volume 1952 ccm

Piston kit-Set

OEM NO. 12010-G5502



Piston

SIZE

Comp : 46.6 w/al-fin Height : -1.7 Length : 78.0
Top Shape : Flower
Pin : 25.0 Length : 67.0

STD

Piston Ring

OEM NO. 12033-W1700
NPR : SDN30-098ZZ



OEM Ring Groove

SIZE

Top : 2.0
2nd : 2.0
Oil : 4.0

STD

Cylinder Liner

OEM NO.



Liner&Sleeve

SIZE

In Diameter :
Out Diameter :
Total length :
Flange :

STD

Engine Bearing

MAIN : 12207-U6000
CON.ROD : 12111-73400
T/W :
C/B :
BUSH : 12030-W3400

SIZE



STD

Engine Valve

OEM NO. 13201-V0700
IN 39.0 8.0 117.2
OEM NO. 13202-V0701
EX 32.0 8.0 117.2

SIZE

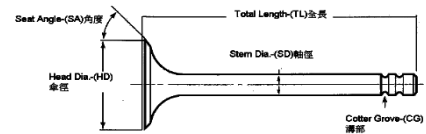

STD

Valve Seat

OEM NO.
IN
OEM NO.
EX

SIZE

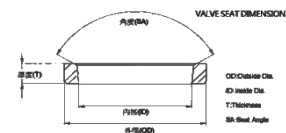

STD

Valve Guide

OEM NO. 13212-21010/21011
IN/EX 59.0 8.0 12.0

SIZE

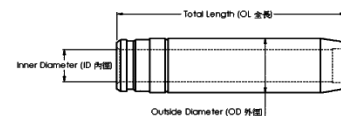

STD

Gasket Set

OEM NO.



NISSAN LD20

Application : VAN
Number of Cylinders 4
Cylinder dia.85.0 MM
Swept Volume 1952 ccm

Piston kit-Set

OEM NO. 12010-W1702



Piston

SIZE

Comp : 46.5 w/al-fin Height : -2.6 Length : 86.4
Top Shape : Flower
Pin : 25.0 Length : 67.0

STD

Piston Ring

OEM NO. 12033-W1700
NPR : SDN30-098ZZ



OEM Ring Groove

SIZE

Top : 2.0
2nd : 2.0
Oil : 4.0

STD

Cylinder Liner

OEM NO.



Liner&Sleeve

SIZE

In Diameter :
Out Diameter :
Total length :
Flange :

STD

Engine Bearing

MAIN : 12207-U6000
CON.ROD : 12111-73400
T/W :
C/B :
BUSH : 12030-W3400

SIZE



STD

Engine Valve

OEM NO. 13201-V0700
IN 39.0 8.0 117.2
OEM NO. 13202-V0701
EX 32.0 8.0 117.2

SIZE

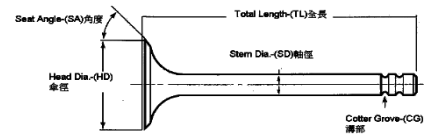

STD

Valve Seat

OEM NO.
IN
OEM NO.
EX

SIZE

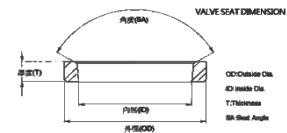

STD

Valve Guide

OEM NO. 13212-21010/21011
IN/EX 59.0 8.0 12.0

SIZE

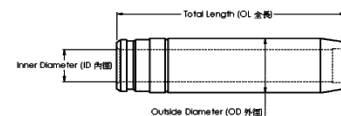

STD

Gasket Set

OEM NO.



NISSAN LD28

Application : CEDRIC
Number of Cylinders 6
Cylinder dia. 84.5 MM
Swept Volume 2792 ccm

Piston kit-Set

OEM NO. 12010-V0702

Piston	SIZE
Comp : 46.5 w/al-fin Height : -3.3 Length : 86.4 Top Shape : Flower Pin : 25.0 Length : 67.0	STD



Piston Ring

OEM NO. 12033-V0700
NPR : SDN30-067ZZ

OEM Ring Groove	SIZE
Top : 2.0 2nd : 2.0 Oil : 4.0	STD



Cylinder Liner

OEM NO.

Liner&Sleeve	SIZE
In Diameter : Out Diameter : Total length : Flange :	STD



Engine Bearing

MAIN : 12207-73400
CON.ROD : 12111-73400
T/W :
C/B :
BUSH : 12030-W3400

SIZE
STD



Engine Valve

OEM NO. 13201-V0700
IN 39.0 8.0 117.2
OEM NO. 13202-V0701
EX 32.0 8.0 117.2

SIZE
STD

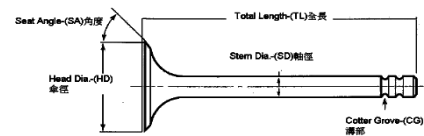

Valve Seat

OEM NO.
IN
OEM NO.
EX

SIZE
STD

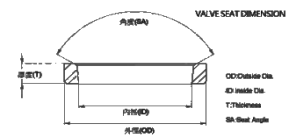

Valve Guide

OEM NO. 13212-21010/21011
IN/EX 59.0 8.0 12.0

SIZE
STD

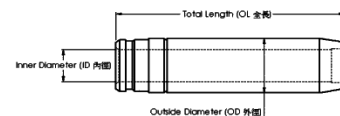

Gasket Set

OEM NO.



NISSAN ND6

Application : TRUCK
Number of Cylinders 6
Cylinder dia. 110.0 MM
Swept Volume 6842 ccm

Piston kit-Set

OEM NO. 12011-95000

Piston	SIZE
Comp : 68.3 w/al-fin Height : -23.3 Length : 113.3 Top Shape : Ø60.0 Direct Injection Pin : 36.0 Length : 94.0	STD

Piston Ring

OEM NO. 12040-95006
 NPR : SDN31-006ZZ

OEM Ring Groove	SIZE
Top : 4.0 2nd : 3.0 Oil : 5.0	STD



Cylinder Liner

OEM NO. 11012-95001

Liner&Sleeve	SIZE
In Diameter : 110.0 Out Diameter : 115.0 Total length : 229.0 Flange : 119.0*3.0+1.1	STD



Engine Bearing

MAIN : 12213-95025
 CON.ROD : 12117-95007
 T/W : 12280-95025
 C/B : 13003-95026
 BUSH : 12030-95000

SIZE
STD



Engine Valve

OEM NO. 13201-95000
 IN 50.0 10.0 143.0
 OEM NO. 13202-95000
 EX 41.0 10.0 143.0

SIZE
STD

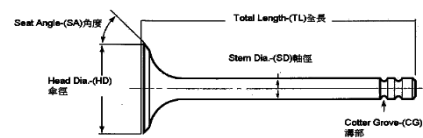

Valve Seat

OEM NO.
 IN
 OEM NO.
 EX

SIZE
STD

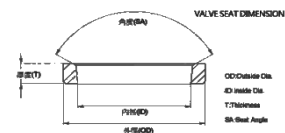

Valve Guide

OEM NO. 13211-95000/13211-95001
 IN/EX 72.0 10.0 15.0

SIZE
STD

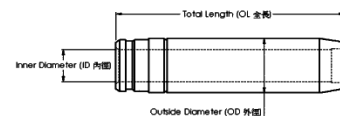

Gasket Set

OEM NO.



NISSAN ND6T

Application : TRUCK
Number of Cylinders 6
Cylinder dia. 110.0 MM
Swept Volume 6842 ccm

Piston kit-Set

OEM NO. 12011-95004

Piston	SIZE
Comp : 68.3 w/al-fin Height : Length : 113.3 Top Shape : Ø Direct Injection Pin : 36.0 Length : 94.0	STD

Piston Ring

OEM NO. 12040-95326
NPR : SDN31-017ZZ

OEM Ring Groove	SIZE
Top : 4.0DK 2nd : 3.0 Oil : 5.0	STD



Cylinder Liner

OEM NO. 11012-95001

Liner&Sleeve	SIZE
In Diameter : 110.0 Out Diameter : 115.0 Total length : 229.0 Flange : 119.0*3.0+1.1	STD



Engine Bearing

MAIN : 12213-95025
CON.ROD : 12117-95007
T/W : 12280-95025
C/B : 13003-95026
BUSH : 12030-95000

SIZE
STD



Engine Valve

OEM NO. 13201-95000
IN 50.0 10.0 143.0
OEM NO. 13202-95000
EX 41.0 10.0 143.0

SIZE
STD

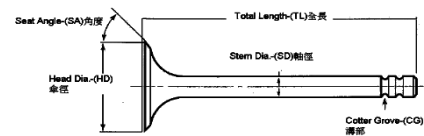

Valve Seat

OEM NO.
IN
OEM NO.
EX

SIZE
STD

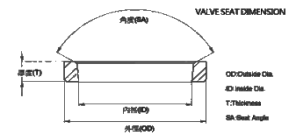

Valve Guide

OEM NO. 13211-95000/13211-95001
IN/EX 72.0 10.0 15.0

SIZE
STD

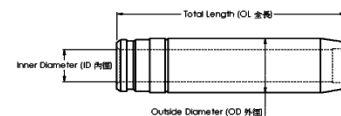

Gasket Set

OEM NO.



NISSAN NE6

Application : TRUCK
Number of Cylinders 6
Cylinder dia. 110.0 MM
Swept Volume 7000 ccm

Piston kit-Set

OEM NO. 12011-95010/12011-95073

Piston	SIZE
Comp : 68.4 w/al-fin Height : -23.0 Length : 110.2 Top Shape : Ø61.0 Direct Injection Pin : 36.0 Length : 95.0	STD



Piston Ring

OEM NO. 12040-95006
NPR : SDN31-006ZZ

OEM Ring Groove	SIZE
Top : 4.0 2nd : 2.5 Oil : 5.0	STD



Cylinder Liner

OEM NO. 11012-95065

Liner&Sleeve	SIZE
In Diameter : 110.0 Out Diameter : 115.0 Total length : 229.0 Flange : 121.0*3.0+1.1	STD



Engine Bearing

MAIN : 12213-95025
CON.ROD : 12117-95007
T/W : 12280-95025
C/B : 13003-95026
BUSH : 12030-95000

SIZE
STD



Engine Valve

OEM NO. 13201-95006
IN 52.0 10.0 143.7
OEM NO. 13202-95003
EX 43.0 10.0 143.4

SIZE
STD

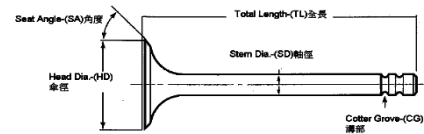

Valve Seat

OEM NO. 13214-95008
IN 54.0 46.0 6.1
OEM NO. 13215-95007
EX 45.0 37.0 6.5

SIZE
STD

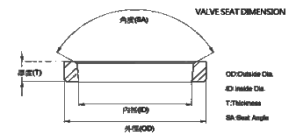

Valve Guide

OEM NO. 13212-95005
IN/EX 72.0 10.0 15.0

SIZE
STD

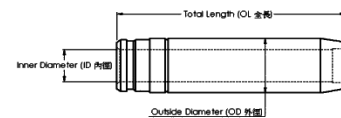

Gasket Set

OEM NO.



NISSAN NE6T

Application : TRUCK
Number of Cylinders 6
Cylinder dia. 110.0 MM
Swept Volume 7000 ccm

Piston kit-Set

OEM NO. 12010-95074

Piston

SIZE

Comp : 68.3 w/al-fin Height : -20.6 Length : 110.3
Top Shape : Ø61.0
Direct Injection
Pin : 36.0 Length : 95.0

STD

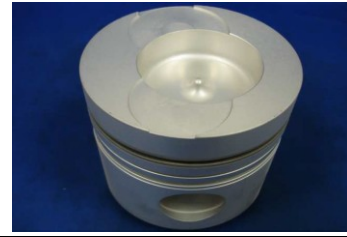

Piston Ring

OEM NO. 12040-95012

NPR : SDN31-031ZZ

OEM Ring Groove

SIZE

Top : 3.0K
2nd : 2.5
Oil : 4.0

STD



Cylinder Liner

OEM NO. 11012-95065

Liner&Sleeve

SIZE

In Diameter : 110.0
Out Diameter : 115.0
Total length : 229.0
Flange : 121.0*3.0+1.1

STD



Engine Bearing

MAIN : 12213-95025

CON.ROD : 12117-95007

T/W : 12280-95025

C/B : 13003-95026

BUSH : 12030-95000

SIZE

STD



Engine Valve

OEM NO. 13201-95006

IN 52.0 10.0 143.7

OEM NO. 13202-95003

EX 43.0 10.0 143.4

SIZE

STD

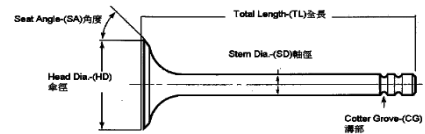

Valve Seat

OEM NO. 13214-95008

IN 54.0 46.0 6.1

OEM NO. 13215-95007

EX 45.0 37.0 6.5

SIZE

STD

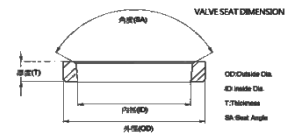

Valve Guide

OEM NO. 13212-95005

IN/EX 72.0 10.0 15.0

SIZE

STD

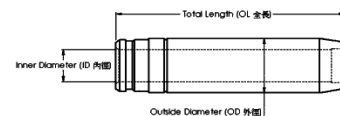

Gasket Set

OEM NO.



NISSAN NE6T

Application : TRUCK
Number of Cylinders 6
Cylinder dia. 110.0 MM
Swept Volume 7000 ccm

Piston kit-Set

OEM NO. 12010-95074/12011-95105

Piston	SIZE
Comp : 68.3 w/al-fin Height : -23.0 Length : 110.2 Top Shape : Ø61.0 Direct Injection Pin : 36.0 Length : 95.0	STD



Piston Ring

OEM NO. 12040-95012
 NPR : SDN31-031ZZ

OEM Ring Groove	SIZE
Top : 3.0K 2nd : 2.5 Oil : 4.0	STD



Cylinder Liner

OEM NO. 11012-95065

Liner&Sleeve	SIZE
In Diameter : 110.0 Out Diameter : 115.0 Total length : 229.0 Flange : 121.0*3.0+1.1	STD



Engine Bearing

MAIN : 12213-95025
 CON.ROD : 12117-95007
 T/W : 12280-95025
 C/B : 13003-95026
 BUSH : 12030-95000

SIZE
 STD



Engine Valve

OEM NO. 13201-95006
 IN 52.0 10.0 143.7
 OEM NO. 13202-95003
 EX 43.0 10.0 143.4

SIZE
 STD

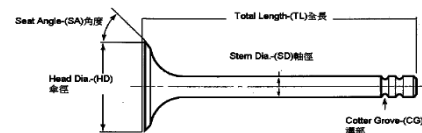

Valve Seat

OEM NO. 13214-95008
 IN 54.0 46.0 6.1
 OEM NO. 13215-95007
 EX 45.0 37.0 6.5

SIZE
 STD

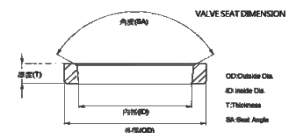

Valve Guide

OEM NO. 13212-95005
 IN/EX 72.0 10.0 15.0

SIZE
 STD

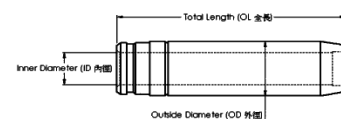

Gasket Set

OEM NO.



NISSAN NE6TA

Application : TRUCK
Number of Cylinders 6
Cylinder dia. 110.0 MM
Swept Volume 7000 ccm

Piston kit-Set

OEM NO. 12010-94114

Piston

SIZE

Comp : 68.4 w/al-fin Height : -27.9 Length : 109.9
 Top Shape : Ø54.9
 Direct Injection Head Anodized
 Pin : 38.0 Length : 93.0

STD

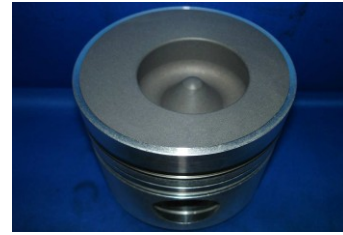

Piston Ring

OEM NO. 12040-95012

NPR : SDN31-031ZZ

OEM Ring Groove

SIZE

Top : 3.0K
 2nd : 2.5
 Oil : 4.0

STD



Cylinder Liner

OEM NO. 11012-95065

Liner&Sleeve

SIZE

In Diameter : 110.0
 Out Diameter : 115.0
 Total length : 229.0
 Flange : 121.0*3.0+1.1

STD



Engine Bearing

MAIN : 12213-95025
 CON.ROD : 12117-95007
 T/W : 12280-95025
 C/B : 13003-95026
 BUSH : 12030-95000

SIZE

STD



Engine Valve

OEM NO. 13201-95006
 IN 52.0 10.0 143.7
 OEM NO. 13202-95003
 EX 43.0 10.0 143.4

SIZE

STD

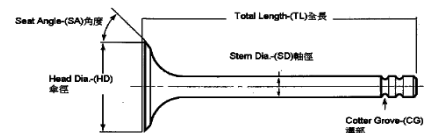

Valve Seat

OEM NO. 13214-95008
 IN 54.0 46.0 6.1
 OEM NO. 13215-95007
 EX 45.0 37.0 6.5

SIZE

STD

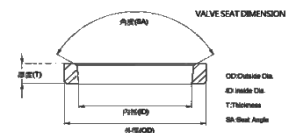

Valve Guide

OEM NO. 13212-95005
 IN/EX 72.0 10.0 15.0

SIZE

STD

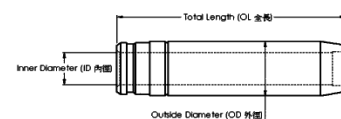

Gasket Set

OEM NO.



NISSAN NF6TA

Application : TRUCK
Number of Cylinders 6
Cylinder dia. 120.0 MM
Swept Volume 9160 ccm

Piston kit-Set

OEM NO. 12011-95516

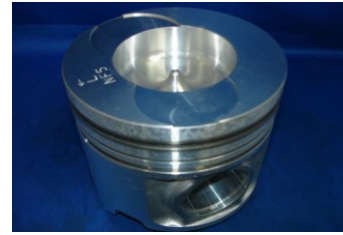

Piston

SIZE

Comp : 71.3 w/al-fin Height : -24.8 oil-cooled Length : 116.5
Top Shape : Ø66.0
Direct Injection
Pin : 44.0 Length : 101.0

STD

Piston Ring

OEM NO. 12040-95001
NPR : SDN31-060ZZ



OEM Ring Groove

SIZE

Top : 3.0K
2nd : 2.5
Oil : 4.0

STD

Cylinder Liner

OEM NO. 11012-95515



Liner&Sleeve

SIZE

In Diameter : 120.0
Out Diameter : 123.0
Total length : 226.0
Flange : 129.0*8.0+1.2

STD

Engine Bearing

MAIN :
CON.ROD :
T/W :
C/B :
BUSH :

SIZE



STD

Engine Valve

OEM NO.
IN 52.0 10.0 157.8
OEM NO.
EX 47.0 10.0 157.8

SIZE

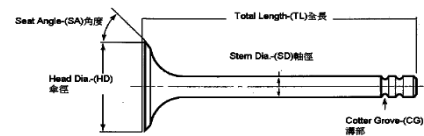

STD

Valve Seat

OEM NO.
IN
OEM NO. 13215-95500
EX

SIZE

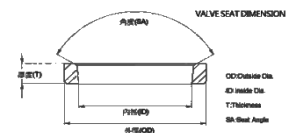

STD

Valve Guide

OEM NO. 13212-95005
IN/EX 72.0 10.0 15.0

SIZE

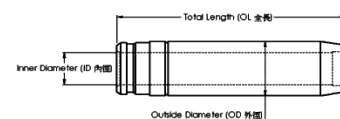

STD

Gasket Set

OEM NO.



NISSAN PD6

Application : TRUCK
Number of Cylinders 6
Cylinder dia. 125.0 MM
Swept Volume 10308 ccm

Piston kit-Set

OEM NO. 12011-96000



Piston

SIZE

Comp : 82.0 w/al-fin Height : -32.0 Length : 132.0
Top Shape : Ø69.0
Direct Injection
Pin : 46.0 Length : 108.0

STD

Piston Ring

OEM NO. 12040-90029

NPR : SDN31-007ZZ



OEM Ring Groove

SIZE

Top : 5.0
2nd : 3.5
Oil : 5.0

STD

Cylinder Liner

OEM NO. 11012-96001



Liner&Sleeve

SIZE

In Diameter : 125.0
Out Diameter : 130.0
Total length : 259.0
Flange : 134.0*3.0+1.0

STD

Engine Bearing

MAIN : 12212-96000

CON.ROD : 12111-96012

T/W : 12280-96025

C/B : 13003-96026

BUSH : 12030-96000

SIZE



STD

Engine Valve

OEM NO. 13201-96003

IN 57.5 12.0 158.5

OEM NO. 13202-96001

EX 47.0 12.0 158.0

SIZE

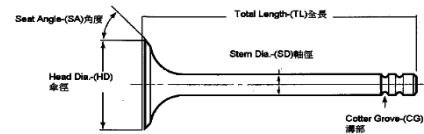

STD

Valve Seat

OEM NO. 13214-96003/04

IN 58.5 52.0 5.1

OEM NO. 13215-96003/04

EX 51.0 43.0 5.1

SIZE

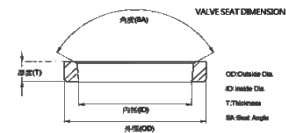

STD

Valve Guide

OEM NO. 13212-96001

IN 75.0 12.0 17.0

OEM NO. 13211-97001/13211-97002

EX 78.0 12.0 17.0

SIZE

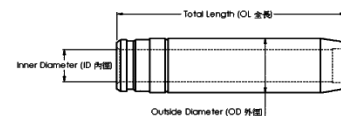

STD

Gasket Set

OEM NO.



NISSAN PD6T

Application : TRUCK
Number of Cylinders 6
Cylinder dia. 125.0 MM
Swept Volume 10308 ccm

Piston kit-Set

OEM NO. 12011-96005

Piston	SIZE
Comp : 82.2 w/al-fin Height : -28.8 Length : 132.0 Top Shape : Ø59.2 Direct Injection Pin : 46.0 Length : 108.0	STD



Piston Ring

OEM NO. 12040-96125
NPR : SDN31-012ZZ

OEM Ring Groove	SIZE
Top : 4.0DK 2nd : 3.5 Oil : 5.0	STD



Cylinder Liner

OEM NO. 11012-96001

Liner&Sleeve	SIZE
In Diameter : 125.0 Out Diameter : 130.0 Total length : 259.0 Flange : 134.0*3.0+1.0	STD



Engine Bearing

MAIN : 12212-96000
CON.ROD : 12111-96012
T/W : 12280-96025
C/B : 13003-96026
BUSH : 12030-96000

SIZE
STD



Engine Valve

OEM NO. 13201-96003
IN 57.5 12.0 158.5
OEM NO. 13202-96001
EX 47.0 12.0 158.0

SIZE
STD

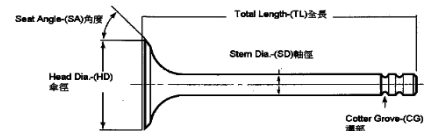

Valve Seat

OEM NO. 13214-96003/04
IN 58.5 52.0 5.1
OEM NO. 13215-96003/04
EX 51.0 43.0 5.1

SIZE
STD

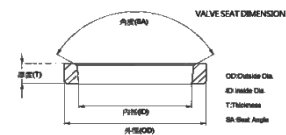

Valve Guide

OEM NO. 13212-96001
IN 75.0 17.0 12.0
OEM NO. 13211-97001/13211-97002
EX 78.0 17.0 12.0

SIZE
STD

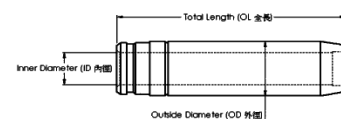

Gasket Set

OEM NO.



NISSAN PE6

Application : TRUCK
Number of Cylinders 6
Cylinder dia. 133.0 MM
Swept Volume 11670 ccm

Piston kit-Set

OEM NO. 12011-96548



Piston

SIZE

Comp : 82.2 w/al-fin Height : -32.9 Length : 132.0
Top Shape : Ø67.0
Direct Injection
Pin : 46.0 Length : 116.0

STD

Piston Ring

OEM NO. 12040-90225

NPR : SDN31-011ZZ

OEM Ring Groove

SIZE

Top : 4.0DK
2nd : 3.5
Oil : 6.0

STD



Cylinder Liner

OEM NO. 11012-96501

Liner&Sleeve

SIZE

In Diameter : 133.0
Out Diameter : 138.0
Total length : 259.0
Flange : 142.0*3.0+1.0

STD



Engine Bearing

MAIN : 12212-96000

CON.ROD : 12111-96012

T/W : 12280-96025

C/B : 13003-96227

BUSH : 12030-96000

SIZE

STD



Engine Valve

OEM NO. 13201-96004/02

IN 57.5 12.0 157.5

OEM NO. 13202-96001

EX 47.0 12.0 158.0

SIZE

STD

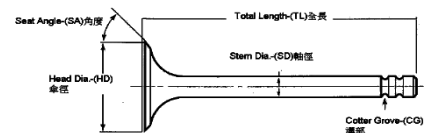

Valve Seat

OEM NO. 13214-96013

IN 58.5 51.3 6.9

OEM NO. 13215-96013

EX 51.0 43.0 7.1

SIZE

STD

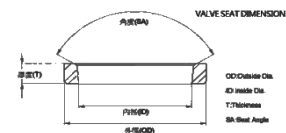

Valve Guide

OEM NO. 13212-96001

IN 75.0 12.0 17.0

OEM NO. 13211-96009

EX 78.0 12.0 17.0

SIZE

STD

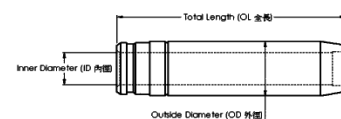

Gasket Set

OEM NO.



NISSAN PE6T

Application : TRUCK
Number of Cylinders 6
Cylinder dia. 133.0 MM
Swept Volume 11670 ccm

Piston kit-Set

OEM NO. 12011-96515/12011-96509

Piston	SIZE
Comp : 82.1 w/al-fin Height : -32.9 Length : 132.0 Top Shape : Ø67.0 Direct Injection Pin : 46.0 Length : 116.0	STD

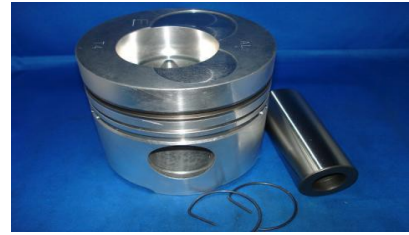

Piston Ring

OEM NO. 12040-96225
NPR : SDN31-022ZZ

OEM Ring Groove	SIZE
Top : 4.0K 2nd : 3.5 Oil : 6.0	STD



Cylinder Liner

OEM NO. 11012-96501

Liner&Sleeve	SIZE
In Diameter : 133.0 Out Diameter : 138.0 Total length : 259.0 Flange : 142.0*3.0+1.0	STD



Engine Bearing

MAIN : 12212-96000
CON.ROD : 12111-96012
T/W : 12280-96025
C/B : 13003-96227
BUSH : 12030-96000

SIZE
STD



Engine Valve

OEM NO. 13201-96004/02
IN 57.5 12.0 157.5
OEM NO. 13202-96001
EX 47.0 12.0 158.0

SIZE
STD

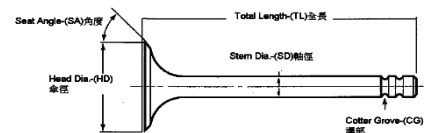

Valve Seat

OEM NO. 13214-96013
IN 58.5 51.3 6.9
OEM NO. 13215-96013
EX 51.0 43.0 7.1

SIZE
STD

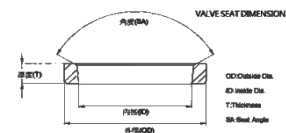

Valve Guide

OEM NO. 13212-96001
IN 75.0 12.0 17.0
OEM NO. 13211-96009
EX 78.0 12.0 17.0

SIZE
STD

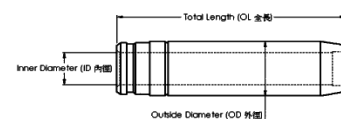

Gasket Set

OEM NO.



NISSAN PE6T

Application : TRUCK
Number of Cylinders 6
Cylinder dia. 133.0 MM
Swept Volume 11670 ccm

Piston kit-Set

OEM NO. 12011-96564

Piston	SIZE
Comp : 82.0 w/al-fin Height : Length : 132.0 Top Shape : Ø Direct Injection Pin : 46.0 Length : 116.0	STD

Piston Ring

OEM NO. 12040-90225
NPR : SDN31-011ZZ

OEM Ring Groove	SIZE
Top : 4.0DK 2nd : 3.5 Oil : 6.0	STD



Cylinder Liner

OEM NO. 11012-96501

Liner&Sleeve	SIZE
In Diameter : 133.0 Out Diameter : 138.0 Total length : 259.0 Flange : 142.0*3.0+1.0	STD



Engine Bearing

MAIN : 12212-96000
CON.ROD : 12111-96012
T/W : 12280-96025
C/B : 13003-96227
BUSH : 12030-96000

SIZE
STD



Engine Valve

OEM NO. 13201-96004/02
IN 57.5 12.0 157.5
OEM NO. 13202-96001
EX 47.0 12.0 158.0

SIZE
STD

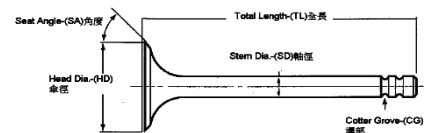

Valve Seat

OEM NO. 13214-96013
IN 58.5 51.3 6.9
OEM NO. 13215-96013
EX 51.0 43.0 7.1

SIZE
STD

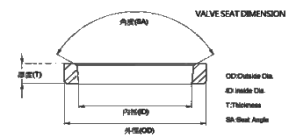

Valve Guide

OEM NO. 13212-96001
IN 75.0 12.0 17.0
OEM NO. 13211-96009
EX 78.0 12.0 17.0

SIZE
STD

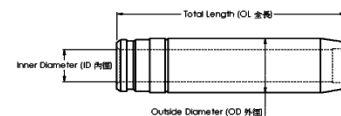

Gasket Set

OEM NO.



NISSAN PE6TB

Application : TRUCK
Number of Cylinders 6
Cylinder dia. 133.0 MM
Swept Volume 11670 ccm

Piston kit-Set

OEM NO. 12011-96572

Piston

SIZE

Comp : 82.1 w/al-fin Height : -32.9 Length : 132.0
Top Shape : Ø67.0
Direct Injection Head Anodized
Pin : 46.0 Length : 116.0

STD



Piston Ring

OEM NO. 12040-96517

NPR : SDN31-041ZZ

OEM Ring Groove

SIZE

Top : 3.0K
2nd : 2.5
Oil : 4.0

STD



Cylinder Liner

OEM NO. 11012-96501

Liner&Sleeve

SIZE

In Diameter : 133.0
Out Diameter : 138.0
Total length : 259.0
Flange : 142.0*3.0+1.0

STD



Engine Bearing

MAIN : 12212-96000
CON.ROD : 12111-96012
T/W : 12280-96025
C/B : 13003-96227
BUSH : 12030-96000

SIZE

STD



Engine Valve

OEM NO. 13201-96003/06
IN 57.5 12.0 158.6
OEM NO. 13202-96001
EX 47.0 12.0 158.0

SIZE

STD

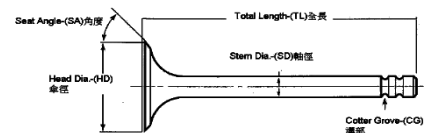

Valve Seat

OEM NO. 13214-96013
IN 58.5 51.3 6.9
OEM NO. 13215-96013
EX 51.0 43.0 7.1

SIZE

STD

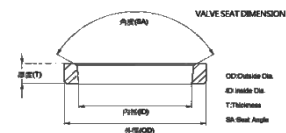

Valve Guide

OEM NO. 13212-96001
IN 75.0 12.0 17.0
OEM NO. 13211-96009
EX 78.0 12.0 17.0

SIZE

STD

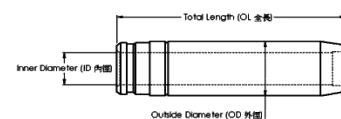

Gasket Set

OEM NO.



NISSAN PE6TC

Application : TRUCK
Number of Cylinders 6
Cylinder dia. 133.0 MM
Swept Volume 11670 ccm

Piston kit-Set

OEM NO. 12011-96600

Piston	SIZE
Comp : 82.1 w/al-fin Height : -32.3 Length : 131.9 Top Shape : Ø67.0 Direct Injection Head Anodized Pin : 46.0 Length : 116.0	STD

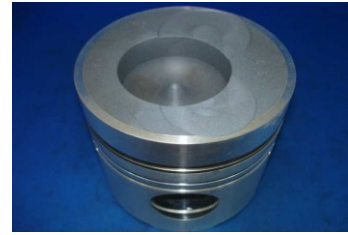

Piston Ring

OEM NO. 12040-96517
NPR : SDN31-041ZZ

OEM Ring Groove	SIZE
Top : 3.0K 2nd : 2.5 Oil : 4.0	STD



Cylinder Liner

OEM NO. 11012-96501

Liner&Sleeve	SIZE
In Diameter : 133.0 Out Diameter : 138.0 Total length : 259.0 Flange : 142.0*3.0+1.0	STD



Engine Bearing

MAIN : 12212-96000
CON.ROD : 12111-96012
T/W : 12280-96025
C/B : 13003-96227
BUSH : 12030-96000

SIZE
STD



Engine Valve

OEM NO. 13201-96004/02
IN 57.5 12.0 157.5
OEM NO. 13202-96001
EX 47.0 12.0 158.0

SIZE
STD

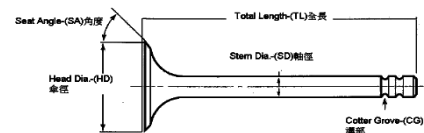

Valve Seat

OEM NO. 13214-96013
IN 58.5 51.3 6.9
OEM NO. 13215-96013
EX 51.0 43.0 7.1

SIZE
STD

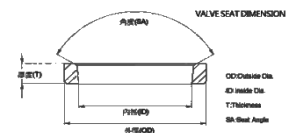

Valve Guide

OEM NO. 13212-96001
IN 75.0 12.0 17.0
OEM NO. 13211-96009
EX 78.0 12.0 17.0

SIZE
STD

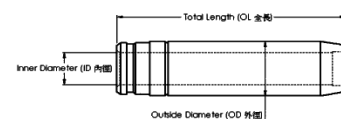

Gasket Set

OEM NO.



NISSAN PF6T

Application : TRUCK
Number of Cylinders 6
Cylinder dia. 133.0 MM
Swept Volume 12503 ccm

Piston kit-Set

OEM NO. 12010-96576

Piston	SIZE
Comp : 86.3 w/al-fin Height : -26.85 Length : 136.0 Top Shape : Ø77.0 Direct Injection Head Anodized Pin : 50.0 Length : 113.0	STD

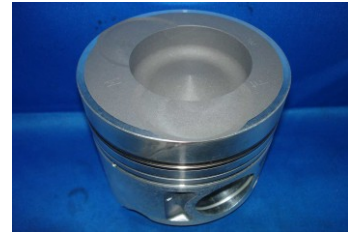

Piston Ring

OEM NO. 12040-96566
NPR : SDN31-048ZZ

OEM Ring Groove	SIZE
Top : 2.5K 2nd : 2.5 Oil : 4.0	STD



Cylinder Liner

OEM NO. 11012-96565

Liner&Sleeve	SIZE
In Diameter : 133.0 Out Diameter : 138.0 Total length : 259.0 Flange : 144.0*3.0+1.2	STD



Engine Bearing

MAIN : 12213-96526
CON.ROD : 12111-96506
T/W : 12280-96125
C/B : 13003-96127
BUSH : 12030-96002

SIZE
STD



Engine Valve

OEM NO. 13201-96008/09
IN 57.5 12.0 158.6
OEM NO. 13202-96008
EX 54.0 12.0 157.5

SIZE
STD

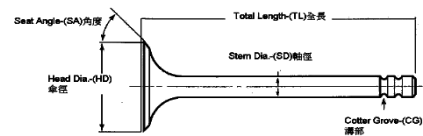

Valve Seat

OEM NO. 13214-96013
IN 58.5 48.5 10.6
OEM NO. 13215-96013
EX 56.0 44.3 11.2

SIZE
STD

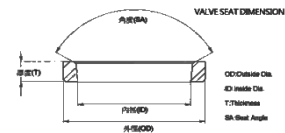

Valve Guide

OEM NO. 13212-96001
IN 75.0 12.0 17.0
OEM NO. 13211-96009
EX 78.0 12.0 17.0

SIZE
STD

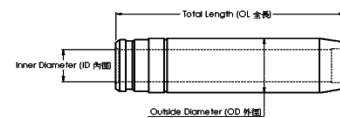

Gasket Set

OEM NO.



NISSAN PF6T

Application : TRUCK
Number of Cylinders 6
Cylinder dia. 133.0 MM
Swept Volume 12503 ccm

Piston kit-Set

OEM NO. 12011-91690

Piston	SIZE
Comp : 86.0 w/al-fin Height : -28.0 Length : 136.0 Top Shape : Ø71.9 Direct Injection Head Anodized Pin : 50.0 Length : 113.0	STD



Piston Ring

OEM NO. 12040-96566
NPR : SDN31-048ZZ

OEM Ring Groove	SIZE
Top : 2.5K 2nd : 2.5 Oil : 4.0	STD



Cylinder Liner

OEM NO. 11012-96565

Liner&Sleeve	SIZE
In Diameter : 133.0 Out Diameter : 138.0 Total length : 259.0 Flange : 144.0*3.0+1.2	STD



Engine Bearing

MAIN : 12213-96526
CON.ROD : 12111-96506
T/W : 12280-96125
C/B : 13003-96127
BUSH : 12030-96002

SIZE
STD



Engine Valve

OEM NO. 13201-96008/09
IN 57.5 12.0 158.6
OEM NO. 13202-96008
EX 54.0 12.0 157.5

SIZE
STD

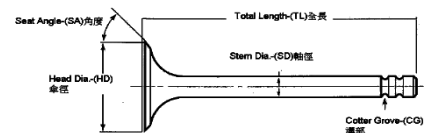

Valve Seat

OEM NO. 13214-96013
IN 58.5 48.5 10.6
OEM NO. 13215-96013
EX 56.0 44.3 11.2

SIZE
STD

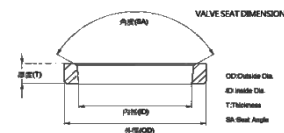

Valve Guide

OEM NO. 13212-96001
IN 75.0 12.0 17.0
OEM NO. 13211-96009
EX 78.0 12.0 17.0

SIZE
STD

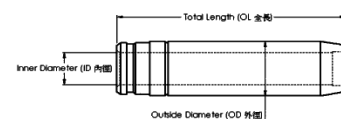

Gasket Set

OEM NO.



NISSAN PF6T

Application : TRUCK
Number of Cylinders 6
Cylinder dia. 133.0 MM
Swept Volume 12503 ccm

Piston kit-Set

OEM NO. 12011-96572

Piston	SIZE
Comp : 86.0 w/al-fin Height : Length : 136.0 Top Shape : Ø66.5 Direct Injection Pin : 50.0 Length : 113.0	STD

Piston Ring

OEM NO. 12040-96566
 NPR : SDN31-048ZZ

OEM Ring Groove	SIZE
Top : 2.5K 2nd : 2.5 Oil : 4.0	STD



Cylinder Liner

OEM NO. 11012-96565

Liner&Sleeve	SIZE
In Diameter : 133.0 Out Diameter : 138.0 Total length : 259.0 Flange : 144.0*3.0+1.2	STD



Engine Bearing

MAIN : 12213-96526
 CON.ROD : 12111-96506
 T/W : 12280-96125
 C/B : 13003-96127
 BUSH : 12030-96002

SIZE
 STD



Engine Valve

OEM NO. 13201-96008/09
 IN 57.5 12.0 158.6
 OEM NO. 13202-96008
 EX 54.0 12.0 157.5

SIZE
 STD

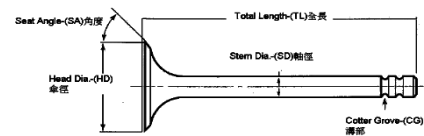

Valve Seat

OEM NO. 13214-96013
 IN 58.5 48.5 10.6
 OEM NO. 13215-96013
 EX 56.0 44.3 11.2

SIZE
 STD

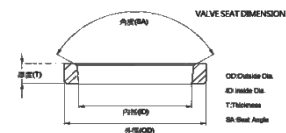

Valve Guide

OEM NO. 13212-96001
 IN 75.0 12.0 17.0
 OEM NO. 13211-96009
 EX 78.0 12.0 17.0

SIZE
 STD

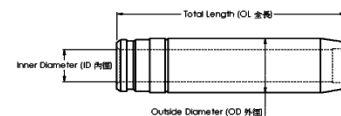

Gasket Set

OEM NO.



NISSAN PF6T

Application : TRUCK
Number of Cylinders 6
Cylinder dia. 133.0 MM
Swept Volume 12503 ccm

Piston kit-Set

OEM NO. 12011-97665



Piston

SIZE

Comp : 86.0 w/al-fin Height : -21.6 oil-cooled Length : 135.7
Top Shape : Ø77.3
Direct Injection
Pin : 50.0 Length : 113.0

STD

Piston Ring

OEM NO. 12040-96566

NPR : SDN31-048ZZ



OEM Ring Groove

SIZE

Top : 2.5HK
2nd : 2.5
Oil : 4.0

STD

Cylinder Liner

OEM NO. 11012-96565



Liner&Sleeve

SIZE

In Diameter : 133.0
Out Diameter : 138.0
Total length : 259.0
Flange : 144.0*3.0+1.2

STD

Engine Bearing

MAIN : 12213-96526

CON.ROD : 12111-96506

T/W : 12280-96125

C/B : 13003-96127

BUSH : 12030-96002

SIZE



STD

Engine Valve

OEM NO. 13201-96008/09

IN 57.5 12.0 158.6

OEM NO. 13202-96008

EX 54.0 12.0 157.5

SIZE

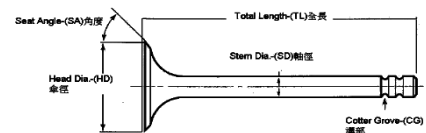

STD

Valve Seat

OEM NO. 13214-96013

IN 58.5 48.5 10.6

OEM NO. 13215-96013

EX 56.0 44.3 11.2

SIZE

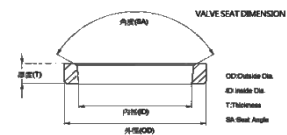

STD

Valve Guide

OEM NO. 13212-96001

IN 75.0 12.0 17.0

OEM NO. 13211-96009

EX 78.0 12.0 17.0

SIZE

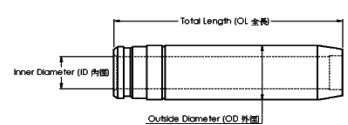

STD

Gasket Set

OEM NO.



NISSAN PF6T

Application : TRUCK
Number of Cylinders 6
Cylinder dia. 133.0 MM
Swept Volume 12503 ccm

Piston kit-Set

OEM NO. 12011-96669



Piston

SIZE

Comp : 86.0 w/al-fin Height : -23.0 oil-cooled Length : 136.0
Top Shape : Ø83.0
Direct Injection
Pin : 50.0 Length : 113.0

STD

Piston Ring

OEM NO.

NPR :

OEM Ring Groove

SIZE

Top : 2.5HK
2nd : 2.5
Oil : 4.0

STD



Cylinder Liner

OEM NO. 11012-96565

Liner&Sleeve

SIZE

In Diameter : 133.0
Out Diameter : 138.0
Total length : 259.0
Flange : 144.0*3.0+1.2

STD



Engine Bearing

MAIN : 12213-96526
CON.ROD : 12111-96506
T/W : 12280-96125
C/B : 13003-96127
BUSH : 12030-96002

SIZE

STD



Engine Valve

OEM NO. 13201-96008/09
IN 57.5 12.0 158.6
OEM NO. 13202-96008
EX 54.0 12.0 157.5

SIZE

STD

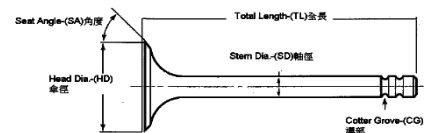

Valve Seat

OEM NO. 13214-96013
IN 58.5 48.5 10.6
OEM NO. 13215-96013
EX 56.0 44.3 11.2

SIZE

STD

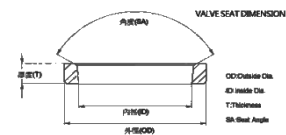

Valve Guide

OEM NO. 13212-96001
IN 75.0 12.0 17.0
OEM NO. 13211-96009
EX 78.0 12.0 17.0

SIZE

STD

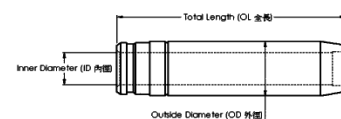

Gasket Set

OEM NO.



NISSAN PF6T

Application : TRUCK
Number of Cylinders 6
Cylinder dia. 133.0 MM
Swept Volume 12503 ccm

Piston kit-Set

OEM NO. 12013-96571

Piston

SIZE

Comp : 86.1 w/al-fin Height : -22.35 oil-cooled Length : 136.1
 Top Shape : Ø82.8
 Direct Injection
 Pin : 50.0 Length : 113.0

STD



Piston Ring

OEM NO. 12040-96517

NPR : SND31-041ZY

OEM Ring Groove

SIZE

Top : 3.0HK
 2nd : 2.5
 Oil : 4.0

STD



Cylinder Liner

OEM NO. 11012-96565

Liner&Sleeve

SIZE

In Diameter : 133.0
 Out Diameter : 138.0
 Total length : 259.0
 Flange : 144.0*3.0+1.2

STD



Engine Bearing

MAIN : 12213-96526

CON.ROD : 12111-96506

T/W : 12280-96125

C/B : 13003-96127

BUSH : 12030-96002

SIZE

STD



Engine Valve

OEM NO. 13201-96008/09

IN 57.5 12.0 158.6

OEM NO. 13202-96008

EX 54.0 12.0 157.5

SIZE

STD

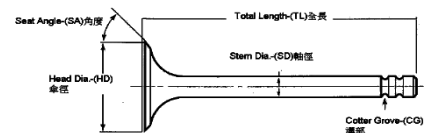

Valve Seat

OEM NO. 13214-96013

IN 58.5 48.5 10.6

OEM NO. 13215-96013

EX 56.0 44.3 11.2

SIZE

STD

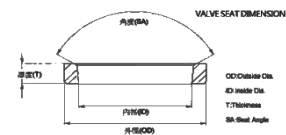

Valve Guide

OEM NO. 13212-96001

IN 75.0 12.0 17.0

OEM NO. 13211-96009

EX 78.0 12.0 17.0

SIZE

STD

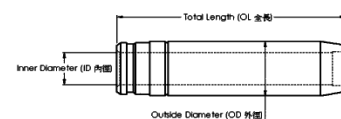

Gasket Set

OEM NO.



NISSAN PF6T

Application : TRUCK
Number of Cylinders 6
Cylinder dia. 133.0 MM
Swept Volume 12503 ccm

Piston kit-Set

OEM NO. 12013-96609



Piston

SIZE

Comp : 86.0 w/al-fin Height : -23.1 oil-cooled Length : 136.0
Top Shape : Ø83.0
Direct Injection
Pin : 50.0 Length : 113.0

STD

Piston Ring

OEM NO. 12040-96566

NPR : SND31-048ZZ



OEM Ring Groove

SIZE

Top : 2.5HK
2nd : 2.5
Oil : 4.0

STD

Cylinder Liner

OEM NO. 11012-96565



Liner&Sleeve

SIZE

In Diameter : 133.0
Out Diameter : 138.0
Total length : 259.0
Flange : 144.0*3.0+1.2

STD

Engine Bearing

MAIN : 12213-96526

CON.ROD : 12111-96506

T/W : 12280-96125

C/B : 13003-96127

BUSH : 12030-96002

SIZE



STD

Engine Valve

OEM NO. 13201-96008/09

IN 57.5 12.0 158.6

OEM NO. 13202-96008

EX 54.0 12.0 157.5

SIZE

STD

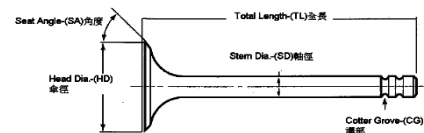

Valve Seat

OEM NO. 13214-96013

IN 58.5 48.5 10.6

OEM NO. 13215-96013

EX 56.0 44.3 11.2

SIZE

STD

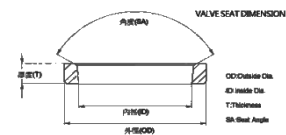

Valve Guide

OEM NO. 13212-96001

IN 75.0 12.0 17.0

OEM NO. 13211-96009

EX 78.0 12.0 17.0

SIZE

STD

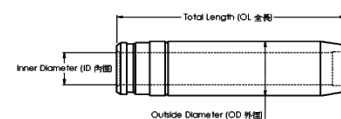

Gasket Set

OEM NO.



NISSAN PF6T

Application : TRUCK
Number of Cylinders 6
Cylinder dia. 133.0 MM
Swept Volume 12503 ccm

Piston kit-Set

OEM NO. 12013-96665



Piston

SIZE

Comp : 86.0 w/al-fin Height : -23.0 oil-cooled Length : 136.0
Top Shape : Ø77.0
Direct Injection
Pin : 50.0 Length : 113.0

STD

Piston Ring

OEM NO. 12040-96566

NPR : SND31-048ZZ



OEM Ring Groove

SIZE

Top : 2.5HK
2nd : 2.5
Oil : 4.0

STD

Cylinder Liner

OEM NO. 11012-96565



Liner&Sleeve

SIZE

In Diameter : 133.0
Out Diameter : 138.0
Total length : 259.0
Flange : 144.0*3.0+1.2

STD

Engine Bearing

MAIN : 12213-96526

CON.ROD : 12111-96506

T/W : 12280-96125

C/B : 13003-96127

BUSH : 12030-96002

SIZE



STD

Engine Valve

OEM NO. 13201-96008/13201-96009

IN 57.5 12.0 158.6

OEM NO. 13202-96008

EX 54.0 12.0 157.5

SIZE

STD

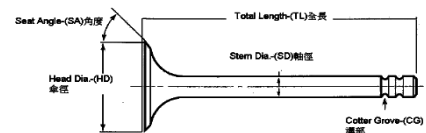

Valve Seat

OEM NO. 13214-96013

IN 58.5 48.5 10.6

OEM NO. 13215-96013

EX 56.0 44.3 11.2

SIZE

STD

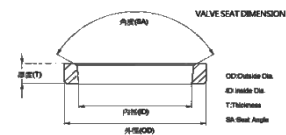

Valve Guide

OEM NO. 13212-96001

IN 75.0 12.0 17.0

OEM NO. 13211-96009

EX 78.0 12.0 17.0

SIZE

STD

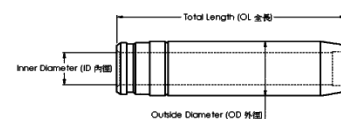

Gasket Set

OEM NO.



NISSAN PF6TB

Application : TRUCK
Number of Cylinders 6
Cylinder dia. 133.0 MM
Swept Volume 12503 ccm

Piston kit-Set

OEM NO. 12011-96972

Piston	SIZE
Comp : 86.0 w/al-fin Height : -29.9 oil-cooled Length : 136.0 Top Shape : Ø72.0 Direct Injection Pin : 50.0 Length : 113.0	STD



Piston Ring

OEM NO. 12040-96566
NPR : SND31-048ZZ

OEM Ring Groove	SIZE
Top : 2.5K 2nd : 2.5 Oil : 4.0	STD



Cylinder Liner

OEM NO. 11012-96565

Liner&Sleeve	SIZE
In Diameter : 133.0 Out Diameter : 138.0 Total length : 259.0 Flange : 144.0*3.0+1.2	STD



Engine Bearing

MAIN : 12213-96526
CON.ROD : 12111-96506
T/W : 12280-96125
C/B : 13003-96127
BUSH : 12030-96002

SIZE
STD



Engine Valve

OEM NO. 13201-96008/09
IN 57.5 12.0 158.6
OEM NO. 13202-96008
EX 54.0 12.0 157.5

SIZE
STD

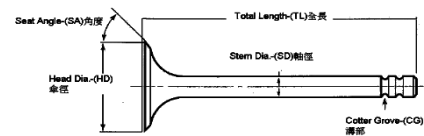

Valve Seat

OEM NO. 13214-96013
IN 58.5 48.5 10.6
OEM NO. 13215-96013
EX 56.0 44.3 11.2

SIZE
STD

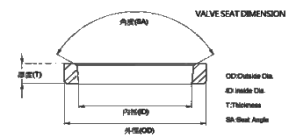

Valve Guide

OEM NO. 13212-96001
IN 75.0 12.0 17.0
OEM NO. 13211-96009
EX 78.0 12.0 17.0

SIZE
STD

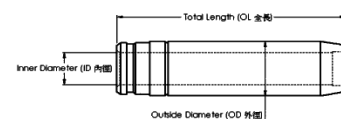

Gasket Set

OEM NO.



NISSAN QD32

Application : TRUCK
Number of Cylinders 4
Cylinder dia. 99.2 MM
Swept Volume 3153 ccm

Piston kit-Set

OEM NO. 12010-2S615



Piston

SIZE

Comp : 45.6 w/al-fin Height : -1.7 oil-cooled Length : 69.8
Top Shape : Flower
Head Anodized
Pin : 33.0 Length : 79.0

STD

Piston Ring

OEM NO. 12033-1W411
NPR : SND31-164ZZ



OEM Ring Groove

SIZE

Top : 2.5K
2nd : 2.0
Oil : 3.0

STD

Cylinder Liner

OEM NO.



Liner&Sleeve

SIZE

In Diameter :
Out Diameter :
Total length :
Flange :

STD

Engine Bearing

MAIN : 12207-43G10
CON.ROD : 12111-43G01
T/W : 12280-37525
C/B : 13002-43G00
BUSH : 12030-2W200



SIZE

STD

Engine Valve

OEM NO. 13201-1W400
IN 45.6 8.0 117.0
OEM NO. 13202-1W400
EX 39.0 8.0 117.0

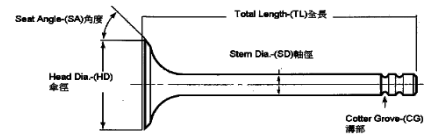

SIZE

STD

Valve Seat

OEM NO.
IN
OEM NO.
EX

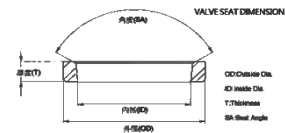

SIZE

STD

Valve Guide

OEM NO.
IN
OEM NO.
EX

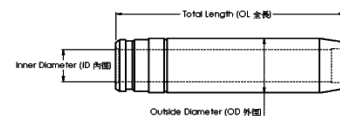

SIZE

STD

Gasket Set

OEM NO.



NISSAN RD8

Application : TRUCK BUS
Number of Cylinders 8
Cylinder dia. 135.0 MM
Swept Volume 14313 ccm

Piston kit-Set

OEM NO. 12011-97004

Piston	SIZE
Comp : 82.0 w/al-fin Height : -25.0 Length : 137.0 Top Shape : Ø71.0 Direct Injection Pin : 46.0 Length : 116.0	STD

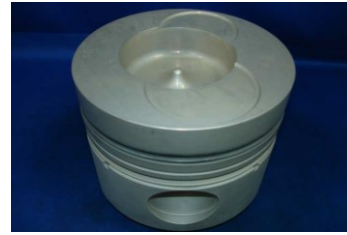

Piston Ring

OEM NO. 12040-97126
NPR : SND31-013ZY

OEM Ring Groove	SIZE
Top : 4.0 2nd : 3.0 Oil : 6.0	STD



Cylinder Liner

OEM NO. 11012-97001

Liner&Sleeve	SIZE
In Diameter : 135.0 Out Diameter : 153.0 Total length : 243.0 Flange : 161.0*8.0+1.2	STD



Engine Bearing

MAIN : 12213-97069
CON.ROD : 12111-97000
T/W : 12280-97025
C/B : 13002-97128
BUSH : 12030-97002

SIZE
STD



Engine Valve

OEM NO. 13201-97000
IN 60.0 10.0 161.0
OEM NO. 13202-97000
EX 50.0 12.0 161.0

SIZE
STD

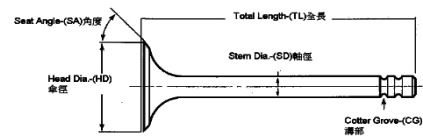

Valve Seat

OEM NO. 13214-97000
IN 62.0 54.0 8.5
OEM NO. 13215-97000
EX 53.0 45.0 9.8

SIZE
STD

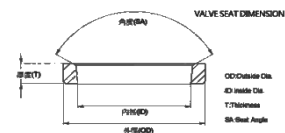

Valve Guide

OEM NO. 13212-97001
IN 79.0 10.0 15.0
OEM NO. 13211-97001
EX 78.0 12.0 17.0

SIZE
STD

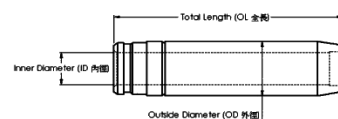

Gasket Set

OEM NO.



NISSAN RD8

Application : TRUCK BUS
Number of Cylinders 8
Cylinder dia. 135.0 MM
Swept Volume 14313 ccm

Piston kit-Set

OEM NO. 12011-97012

Piston

SIZE

Comp : 82.0 w/al-fin Height : -25.0 Length : 137.0
Top Shape : Ø71.0
Direct Injection
Pin : 46.0 Length : 116.0

STD

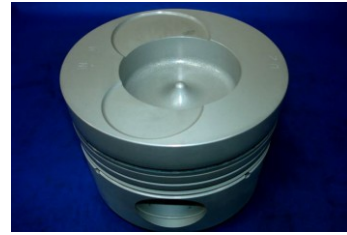

Piston Ring

OEM NO.

NPR : SND31-033ZZ

OEM Ring Groove

SIZE

Top : 3.0
2nd : 3.0
Oil : 5.0

STD



Cylinder Liner

OEM NO. 11012-97001

Liner&Sleeve

SIZE

In Diameter : 135.0
Out Diameter : 153.0
Total length : 243.0
Flange : 161.0*8.0+1.2

STD



Engine Bearing

MAIN : 12213-97069

CON.ROD : 12111-97000

T/W : 12280-97025

C/B : 13002-97128

BUSH : 12030-97002

SIZE

STD



Engine Valve

OEM NO. 13201-97000

IN 60.0 10.0 161.0

OEM NO. 13202-97000

EX 50.0 12.0 161.0

SIZE

STD

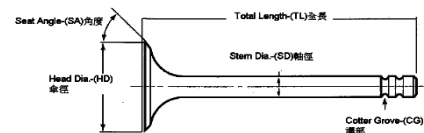

Valve Seat

OEM NO. 13214-97000

IN 62.0 54.0 8.5

OEM NO. 13215-97000

EX 53.0 45.0 9.8

SIZE

STD

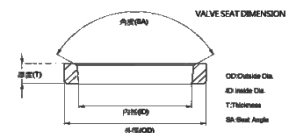

Valve Guide

OEM NO. 13212-97001

IN 79.0 10.0 15.0

OEM NO. 13211-97001

EX 78.0 12.0 17.0

SIZE

STD

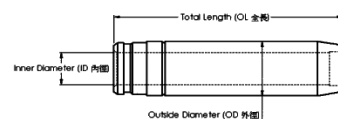

Gasket Set

OEM NO.



NISSAN RD8T

Application : TRUCK BUS
Number of Cylinders 8
Cylinder dia. 135.0 MM
Swept Volume 14313 ccm

Piston kit-Set

OEM NO. 12011-97178

Piston	SIZE
Comp : 82.1 w/al-fin Height : -25.5 Length : 137.0 Top Shape : Ø60.0 Direct Injection Pin : 46.0 Length : 116.0	STD



Piston Ring

OEM NO. 12040-97128
NPR : SND31-018ZZ

OEM Ring Groove	SIZE
Top : 4.0DK 2nd : 3.0 Oil : 6.0	STD



Cylinder Liner

OEM NO. 11012-97001

Liner&Sleeve	SIZE
In Diameter : 135.0 Out Diameter : 153.0 Total length : 243.0 Flange : 161.0*8.0+1.2	STD



Engine Bearing

MAIN : 12213-97069
CON.ROD : 12111-97000
T/W : 12280-97025
C/B : 13002-97128
BUSH : 12030-97002

SIZE
STD



Engine Valve

OEM NO. 13201-97000
IN 60.0 10.0 161.0
OEM NO. 13202-97000
EX 50.0 12.0 161.0

SIZE
STD

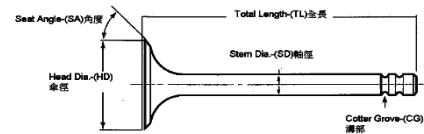

Valve Seat

OEM NO. 13214-97000
IN 62.0 54.0 8.5
OEM NO. 13215-97000
EX 53.0 45.0 9.8

SIZE
STD

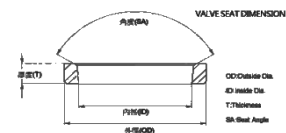

Valve Guide

OEM NO. 13212-97001
IN 79.0 10.0 15.0
OEM NO. 13211-97001
EX 78.0 12.0 17.0

SIZE
STD

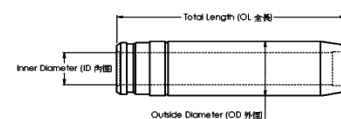

Gasket Set

OEM NO.



Piston kit-Set

OEM NO. 12010-22J11

Piston

SIZE

Comp : 47.3 w/al-fin Height : -2.7 oil-cooled Length : 78.3
Top Shape : Flower

Pin : 27.0 Length : 66.5

STD



Piston Ring

OEM NO. 12033-22J11

NPR : SND30-144ZZ

OEM Ring Groove

SIZE

Top : 2.0
2nd : 2.0
Oil : 3.0

STD



Cylinder Liner

OEM NO.

Liner&Sleeve

SIZE

In Diameter :
Out Diameter :
Total length :
Flange :

STD



Engine Bearing

MAIN :
CON.ROD :
T/W :
C/B :
BUSH :

SIZE

STD



Engine Valve

OEM NO. 13201-40201
IN 39.1 7.0 102.0
OEM NO. 13202-40201
EX 32.0 7.0 102.0

SIZE

STD

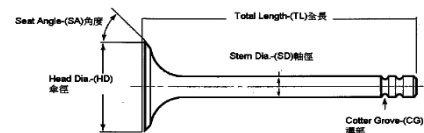

Valve Seat

OEM NO.
IN
OEM NO.
EX

SIZE

STD

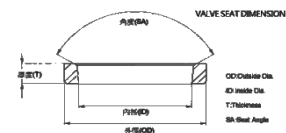

Valve Guide

OEM NO. 13212-D0110
IN 45.2 11.0 7.0
OEM NO. 13211-D0101
EX 45.2 11.0 7.0

SIZE

STD

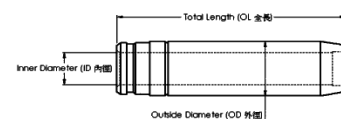

Gasket Set

OEM NO.



NISSAN RE8

Application : TRUCK
Number of Cylinders 8
Cylinder dia. 135.0 MM
Swept Volume 15115 ccm

Piston kit-Set

OEM NO. 12011-97107

Piston	SIZE
Comp : 78.9 w/al-fin Height : -27.7 Length : 137.0 Top Shape : Ø67.0 Direct Injection Pin : 46.0 Length : 116.0	STD



Piston Ring

OEM NO. 12040-97074
NPR : SND31-033ZZ

OEM Ring Groove	SIZE
Top : 3.0 2nd : 3.0 Oil : 5.0	STD



Cylinder Liner

OEM NO. 11012-97118

Liner&Sleeve	SIZE
In Diameter : 135.0 Out Diameter : 153.0 Total length : 238.0 Flange : 161.0*11.0+1.2	STD



Engine Bearing

MAIN : 12213-97069
CON.ROD : 12111-97000
T/W : 12280-97025
C/B : 13003-97128
BUSH : 13030-97002

SIZE
STD



Engine Valve

OEM NO. 13201-97001
IN 60.0 10.0 161.0
OEM NO. 13202-97000
EX 50.0 12.0 161.0

SIZE
STD

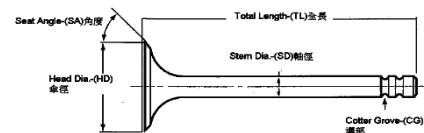

Valve Seat

OEM NO. 13214-97010/11
IN 62.0 54.0 8.5
OEM NO. 13215-97014
EX 55.0 45.0 10.0

SIZE
STD

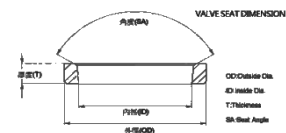

Valve Guide

OEM NO. 13212-97001
IN 79.0 10.0 15.0
OEM NO. 13211-97001
EX 78.0 12.0 17.0

SIZE
STD

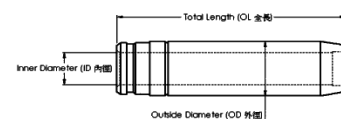

Gasket Set

OEM NO.



NISSAN RF8

Application : TRUCK
Number of Cylinders 8
Cylinder dia. 138.0 MM
Swept Volume 16991 ccm

Piston kit-Set

OEM NO. 12011-97165(R) 12011-97161(L)

Piston	SIZE
Comp : 78.7 w/al-fin Height : -24.9 Length : 137.0 Top Shape : Ø74.0 Direct Injection Pin : 46.0 Length : 116.0	STD



Piston Ring

OEM NO. 12040-97072
NPR : SND31-034ZZ

OEM Ring Groove	SIZE
Top : 2.5 2nd : 2.5 Oil : 4.0	STD



Cylinder Liner

OEM NO. 11012-97164

Liner&Sleeve	SIZE
In Diameter : 138.0 Out Diameter : 159.0 Total length : 238.0 Flange : 167.0*11.0+1.3	STD



Engine Bearing

MAIN : 12213-97069
CON.ROD : 12111-97000
T/W : 12280-97025
C/B : 13003-97128
BUSH : 13030-97002

SIZE
STD



Engine Valve

OEM NO. 13201-97000
IN 60.0 10.0 161.0
OEM NO. 13202-97009
EX 52.0 12.0 161.0

SIZE
STD

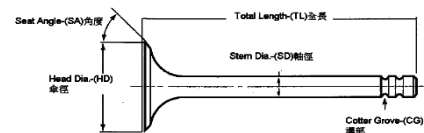

Valve Seat

OEM NO. 13214-97010/11
IN 62.0 54.0 8.5
OEM NO. 13215-97014
EX 55.0 45.0 10.0

SIZE
STD

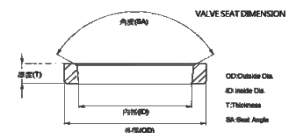

Valve Guide

OEM NO. 13212-95005
IN 72.0 10.0 15.0
OEM NO. 13211-96007/13211-96009
EX 78.0 12.0 17.0

SIZE
STD

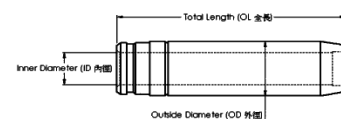

Gasket Set

OEM NO.



NISSAN RF8

Application : TRUCK
Number of Cylinders 8
Cylinder dia. 138.0 MM
Swept Volume 16991 ccm

Piston kit-Set

OEM NO.

Piston

SIZE

Comp : Height : Length :
Top Shape : Ø
Direct Injection
Pin : 46.0 Length :

STD

Piston Ring

OEM NO.

NPR :

OEM Ring Groove

SIZE

Top :
2nd :
Oil :

STD



Cylinder Liner

OEM NO. 11012-97164

Liner&Sleeve

SIZE

In Diameter : 138.0
Out Diameter : 159.0
Total length : 238.0
Flange : 167.0*11.0+1.3

STD



Engine Bearing

MAIN : 12213-97160
CON.ROD : 12117-97075
T/W : 12280-97005
C/B : 13008-97508
BUSH :

SIZE

STD



Engine Valve

OEM NO. 13201-97000
IN 60.0 10.0 161.0
OEM NO. 13202-97009
EX 52.0 12.0 161.0

SIZE

STD

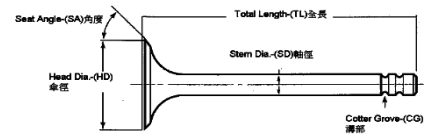

Valve Seat

OEM NO. 13214-97010/11
IN 62.0 54.0 8.5
OEM NO. 13215-97014
EX 55.0 45.0 10.0

SIZE

STD

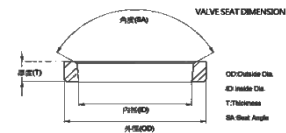

Valve Guide

OEM NO. 13212-95005
IN 72.0 10.0 15.0
OEM NO. 13211-96007/13211-96009
EX 78.0 12.0 17.0

SIZE

STD

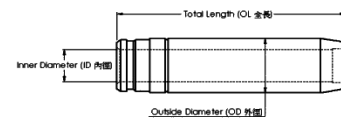

Gasket Set

OEM NO.



NISSAN RF8T

Application : TRUCK
Number of Cylinders 8
Cylinder dia. 138.0 MM
Swept Volume 16991 ccm

Piston kit-Set

OEM NO.

Piston

SIZE

Comp : 78.7 w/al-fin Height : -25.0 oil-cooled Length : 137.0
Top Shape : Ø75.7
Direct Injection
Pin : 50.0 Length : 118.0

STD

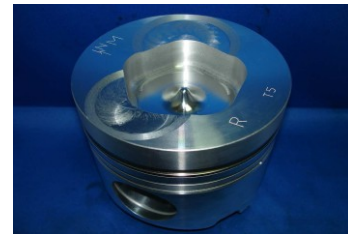

Piston Ring

OEM NO. 12040-97101
RIK : 24335

OEM Ring Groove

SIZE

Top : 3.0K
2nd : 2.5
Oil : 4.0

STD



Cylinder Liner

OEM NO. 11012-97164

Liner&Sleeve

SIZE

In Diameter : 138.0
Out Diameter : 159.0
Total length : 238.0
Flange : 167.0*11.0+1.3

STD



Engine Bearing

MAIN : 12213-97169
CON.ROD : 12111-97000
T/W : 12280-97025
C/B : 13003-97128
BUSH : 12030-97002

SIZE

STD



Engine Valve

OEM NO. 13201-97000
IN 60.0 10.0 161.0
OEM NO. 13202-97009
EX 52.0 12.0 161.0

SIZE

STD

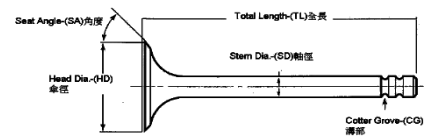

Valve Seat

OEM NO. 13214-97010/11
IN 62.0 54.0 8.5
OEM NO. 13215-97014
EX 55.0 45.0 10.0

SIZE

STD

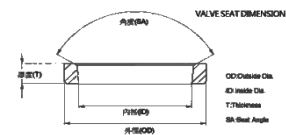

Valve Guide

OEM NO. 13212-95005
IN 72.0 10.0 15.0
OEM NO. 13211-96007/13211-96009
EX 78.0 12.0 17.0

SIZE

STD

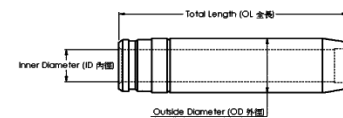

Gasket Set

OEM NO.



NISSAN RF8T

Application : TRUCK
Number of Cylinders 8
Cylinder dia. 138.0 MM
Swept Volume 16991 ccm

Piston kit-Set

OEM NO.

Piston

SIZE

Comp : 78.7 w/al-fin Height : -24.9 oil-cooled Length : 137.0
Top Shape : Ø75.8
Direct Injection
Pin : 50.0 Length : 118.0

STD

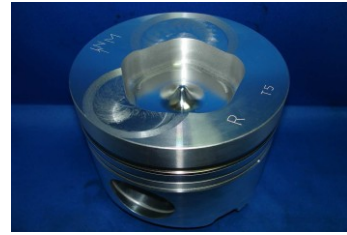

Piston Ring

OEM NO.

NPR :

OEM Ring Groove

SIZE

Top : 3.0K
2nd : 2.5
Oil : 4.0

STD



Cylinder Liner

OEM NO. 11012-97164

Liner&Sleeve

SIZE

In Diameter : 138.0
Out Diameter : 159.0
Total length : 238.0
Flange : 167.0*11.0+1.3

STD



Engine Bearing

MAIN : 12213-97160
CON.ROD : 12117-97075
T/W : 12280-97005
C/B : 13308-97508
BUSH :

SIZE

STD



Engine Valve

OEM NO. 13201-97000
IN 60.0 10.0 161.0
OEM NO. 13202-97009
EX 52.0 12.0 161.0

SIZE

STD

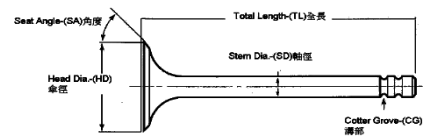

Valve Seat

OEM NO. 13214-97010/11
IN 62.0 54.0 8.5
OEM NO. 13215-97014
EX 55.0 45.0 10.0

SIZE

STD

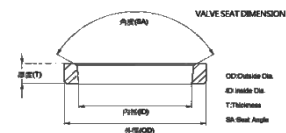

Valve Guide

OEM NO. 13212-95005
IN 72.0 10.0 15.0
OEM NO. 13211-96007/13211-96009
EX 78.0 12.0 17.0

SIZE

STD

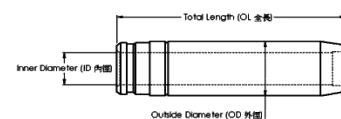

Gasket Set

OEM NO.



NISSAN RF8T-N

Application : TRUCK
Number of Cylinders 8
Cylinder dia. 138.0 MM
Swept Volume 16991 ccm

Piston kit-Set

OEM NO. 12011-97166(R)/12011-97162(L)

Piston	SIZE
Comp : 78.6 w/al-fin Height : -22.5 oil-cooled Length : 137.0 Top Shape : Ø78.0 Direct Injection Head Anodized Pin : 46.0 Length : 116.0	STD



Piston Ring

OEM NO. 12040-97072
NPR : SDN31-034ZZ

OEM Ring Groove	SIZE
Top : 2.5 2nd : 2.5 Oil : 4.0	STD



Cylinder Liner

OEM NO. 11012-97164

Liner&Sleeve	SIZE
In Diameter : 138.0 Out Diameter : 159.0 Total length : 238.0 Flange : 167.0*11.0+1.3	STD



Engine Bearing

MAIN : 12213-97069
CON.ROD : 12111-97000
T/W : 12280-97025
C/B : 13303-97128
BUSH : 12030-97002

SIZE
STD



Engine Valve

OEM NO. 13201-97000
IN 60.0 10.0 161.0
OEM NO. 13202-97009
EX 52.0 12.0 161.0

SIZE
STD

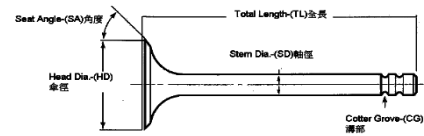

Valve Seat

OEM NO. 13214-97010/11
IN 62.0 54.0 8.5
OEM NO. 13215-97014
EX 55.0 45.0 10.0

SIZE
STD

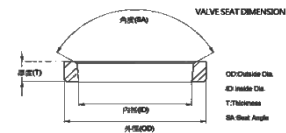

Valve Guide

OEM NO. 13212-95005
IN 72.0 10.0 15.0
OEM NO. 13211-96007/13211-96009
EX 78.0 12.0 17.0

SIZE
STD

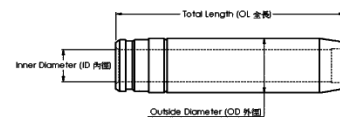

Gasket Set

OEM NO.



NISSAN RG8

Application : TRUCK
Number of Cylinders 8
Cylinder dia. 142.0 MM
Swept Volume 17991 ccm

Piston kit-Set

OEM NO. 12011-97772(R)/12011-97776(L)

Piston	SIZE
Comp : 78.6 w/al-fin Height : -22.8 Length : 137.0 Top Shape : Ø78.0 Direct Injection Head Anodized Pin : 46.0 Length : 116.0	STD



Piston Ring

OEM NO. 12040-97107
NPR : SDN31-059ZZ

OEM Ring Groove	SIZE
Top : 3.0 2nd : 2.5 Oil : 4.0	STD



Cylinder Liner

OEM NO. 11012-97219

Liner&Sleeve	SIZE
In Diameter : 142.0 Out Diameter : 159.0 Total length : 236.0 Flange : 167.0*11.0+1.2	STD



Engine Bearing

MAIN : 12213-97160
CON.ROD : 12117-97075
T/W : 12280-97005
C/B : 13308-97508
BUSH : 12030-97003

SIZE
STD



Engine Valve

OEM NO. 13201-97000
IN 60.0 10.0 161.0
OEM NO. 13202-97009
EX 52.0 12.0 161.0

SIZE
STD

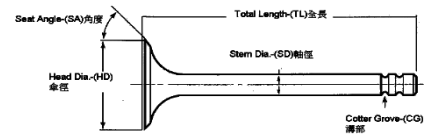

Valve Seat

OEM NO. 13214-97010/11
IN 62.0 54.0 8.5
OEM NO. 13215-97014
EX 55.0 45.0 10.0

SIZE
STD

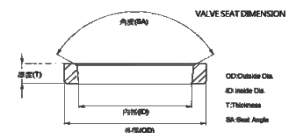

Valve Guide

OEM NO. 13212-95005
IN 72.0 15.0 10.0
OEM NO. 13211-96007/13211-96009
EX 78.0 17.0 12.0

SIZE
STD

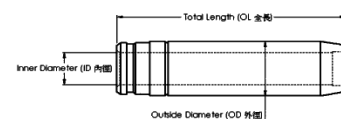

Gasket Set

OEM NO.



NISSAN RH8.RH10

Application : TRUCK
Number of Cylinders 8
Cylinder dia. 150.0 MM
Swept Volume 21205 ccm

Piston kit-Set

OEM NO. 12011-63787(R)/12011-63760(L)

Piston	SIZE
Comp : Height : Length : Top Shape : Ø Direct Injection Pin : Length :	STD

Piston Ring

OEM NO.
NPR :

OEM Ring Groove	SIZE
Top : 2nd : Oil :	STD



Cylinder Liner

OEM NO.

Liner&Sleeve	SIZE
In Diameter : 150.0 Out Diameter : 155.0 Total length : 246.0 Flange : 161.0*8.0+1.2	STD



Engine Bearing

MAIN : 12213-97160
CON.ROD : 12117-97075
T/W : 12280-97005
C/B : 13308-97508
BUSH :

SIZE
STD



Engine Valve

OEM NO. 13201-97010
IN 52.0 10.0 164.4
OEM NO. 13202-97064
EX 48.0 10.0 164.4

SIZE
STD

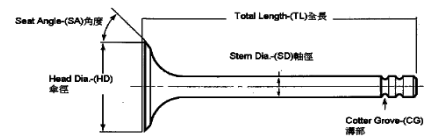

Valve Seat

OEM NO. 13214-97106
IN 54.0 48.0 8.1
OEM NO. 13215-97106
EX 51.0 41.0 10.4

SIZE
STD

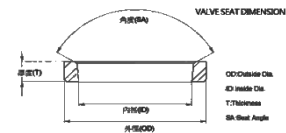

Valve Guide

OEM NO. 13212-95005
IN/EX 72.0 10.0 15.0

SIZE
STD

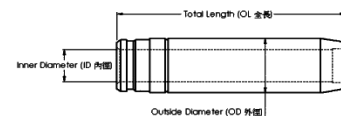

Gasket Set

OEM NO.



Piston kit-Set

OEM NO. 12011-J5310

Piston	SIZE
Comp : 48.0 w/al-fin Height : -2.0 Length : 96.0 Top Shape : Flower Pin : 26.0 Length : 71.0	STD



Piston Ring

OEM NO. 12033-Y1402
NPR : SJN31-003ZZ

OEM Ring Groove	SIZE
Top : 2.5 2nd : 2.0 3rd : 2.0 Oil : 4.5/4.5	STD



Cylinder Liner

OEM NO. 11012-76200

Liner&Sleeve	SIZE
In Diameter : 83.0 Out Diameter : 87.0 Total length : 176.0 Flange : 5.0 Semi/Finish	STD



Engine Bearing

MAIN : 12207-37502
CON.ROD : 12117-Y5200
T/W : 12280-37525
C/B : 13302-37500
BUSH : 12030-37500

SIZE
STD



Engine Valve

OEM NO. 13201-Y5200
IN 38.0 8.0 117.0
OEM NO. 13202-Y5200
EX 32.0 8.0 117.0

SIZE
STD

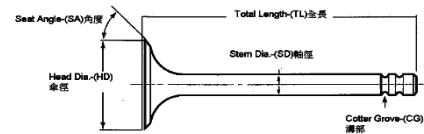

Valve Seat

OEM NO. 13214-Y5200
IN 39.0 33.0 6.5
OEM NO. 13215-Y5200
EX 35.0 27.2 6.5

SIZE
STD

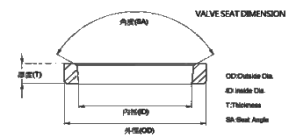

Valve Guide

OEM NO. 13211-V1700
IN/EX 52.0 8.0 12.0

SIZE
STD

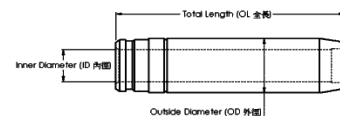

Gasket Set

OEM NO.



NISSAN SD22

Application : TRUCK
Number of Cylinders 4
Cylinder dia. 83.0 MM
Swept Volume 2164 ccm

Piston kit-Set

OEM NO. 12011-R8110

Piston	SIZE
Comp : 48.0 Height : -2.0 Length : 90.0 Top Shape : Flower Pin : 26.0 Length : 71.0	STD

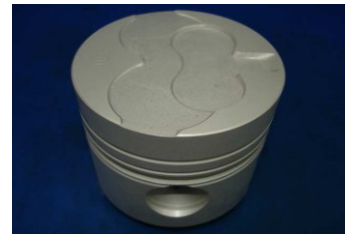

Piston Ring

OEM NO. 12033-R8100
NPR : SDN31-027ZZ

OEM Ring Groove	SIZE
Top : 2.5 2nd : 2.0 Oil : 4.5	STD



Cylinder Liner

OEM NO. 11012-76200

Liner&Sleeve	SIZE
In Diameter : 83.0 Out Diameter : 87.0 Total length : 176.0 Flange : 5.0 Semi/Finish	STD



Engine Bearing

MAIN : 12207-37502
CON.ROD : 12117-Y5200
T/W : 12280-37525
C/B : 13002-37500
BUSH : 12030-37500

SIZE
STD



Engine Valve

OEM NO. 13201-Y5200
IN 38.0 8.0 117.0
OEM NO. 13202-Y5200
EX 32.0 8.0 117.0

SIZE
STD

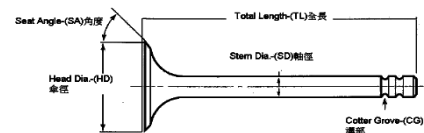

Valve Seat

OEM NO. 13214-Y5200
IN 39.0 33.0 6.5
OEM NO. 13215-Y5200
EX 35.0 27.2 6.5

SIZE
STD

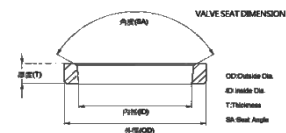

Valve Guide

OEM NO. 13211-V1700
IN/EX 52.0 8.0 12.0

SIZE
STD

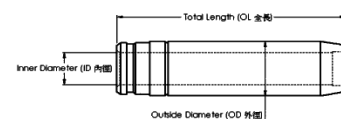

Gasket Set

OEM NO.



NISSAN SD23

Application : TRUCK
Number of Cylinders 4
Cylinder dia. 89.0 MM
Swept Volume 2289 ccm

Piston kit-Set

OEM NO. 12010-T6212

Piston	SIZE
Comp : 48.0 Height : -1.5 Length : 90.0 Top Shape : Flower Pin : 26.0 Length : 74.0	STD

Piston Ring

OEM NO. 12033-L2000
NPR : SDN31-023ZZ

OEM Ring Groove	SIZE
Top : 2.5 2nd : 2.0 Oil : 4.5	STD



Cylinder Liner

OEM NO. 11012-L2002

Liner&Sleeve	SIZE
In Diameter : 89.0 Out Diameter : 92.0 Total length : 172.0 Flange : 98.0*5.0 Semi/Finish	STD



Engine Bearing

MAIN : 12207-V1700
CON.ROD : 12117-Y5200
T/W : 12280-37525
C/B : 13002-90010
BUSH : 12030-37500

SIZE
STD



Engine Valve

OEM NO. 13201-L2000
IN 40.0 8.0 117.0
OEM NO. 13202-L2000
EX 34.0 8.0 117.0

SIZE
STD

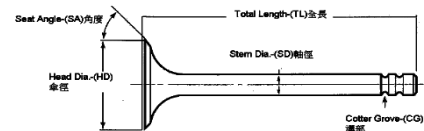

Valve Seat

OEM NO. 13214-L2000
IN 41.0 35.0 6.5
OEM NO. 13215-L2000
EX 37.0 30.5 6.5

SIZE
STD

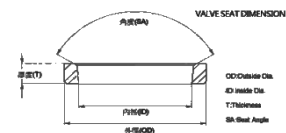

Valve Guide

OEM NO. 13211-V1700
IN/EX 52.0 8.0 12.0

SIZE
STD

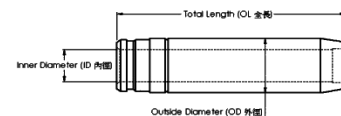

Gasket Set

OEM NO.



NISSAN SD23

Application : TRUCK
Number of Cylinders 4
Cylinder dia. 89.0 MM
Swept Volume 2289 ccm

Piston kit-Set

OEM NO. 12010-T6205/12010-T6212/12010-T7205

Piston	SIZE
Comp : 48.3 Height : -3.2 Length : 80.0 Top Shape : Flower Pin : 26.0 Length : 74.0	STD

Piston Ring

OEM NO. 12033-L2000
NPR : SDN31-023ZZ

OEM Ring Groove	SIZE
Top : 2.5 2nd : 2.0 Oil : 4.5	STD



Cylinder Liner

OEM NO. 11012-L2002

Liner&Sleeve	SIZE
In Diameter : 89.0 Out Diameter : 92.0 Total length : 172.0 Flange : 98.0*5.0 Semi/Finish	STD



Engine Bearing

MAIN : 12207-V1700
CON.ROD : 12117-Y5200
T/W : 12280-37525
C/B : 13302-90010
BUSH : 12030-37500

SIZE
STD



Engine Valve

OEM NO. 13201-L2000
IN 40.0 8.0 117.0
OEM NO. 13202-L2000
EX 34.0 8.0 117.0

SIZE
STD

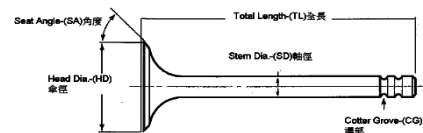

Valve Seat

OEM NO. 13214-L2000
IN 41.0 35.0 6.5
OEM NO. 13215-L2000
EX 37.0 30.5 6.5

SIZE
STD

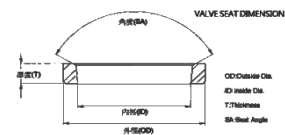

Valve Guide

OEM NO. 13211-V1700
IN/EX 52.0 8.0 12.0

SIZE
STD

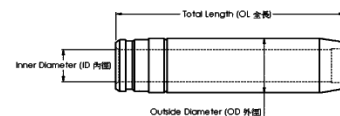

Gasket Set

OEM NO.



Piston kit-Set

OEM NO. 12010-T7210/12010-T7211/12010-T7201

Piston	SIZE
Comp : 48.3 w/al-fin Height : -2.0 Length : 90.0 Top Shape : Flower Pin : 26.0 Length : 74.0	STD



Piston Ring

OEM NO. 12033-L2004
NPR : SDN31-023ZZ

OEM Ring Groove	SIZE
Top : 2.5 2nd : 2.0 Oil : 4.5	STD



Cylinder Liner

OEM NO. 11012-L2002

Liner&Sleeve	SIZE
In Diameter : 89.0 Out Diameter : 92.0 Total length : 172.0 Flange : 98.0*5.0 Semi/Finish	STD



Engine Bearing

MAIN : 12207-V1700
CON.ROD : 12117-Y5200
T/W : 12280-37525
C/B : 13302-90010
BUSH : 12030-37500

SIZE
STD



Engine Valve

OEM NO. 13201-L2000
IN 40.0 8.0 117.0
OEM NO. 13202-L2000
EX 34.0 8.0 117.0

SIZE
STD

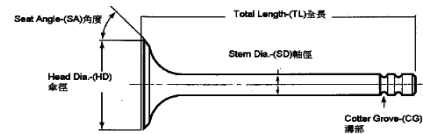

Valve Seat

OEM NO. 13214-L2000
IN 41.0 35.0 6.5
OEM NO. 13215-L2000
EX 37.0 30.5 6.5

SIZE
STD

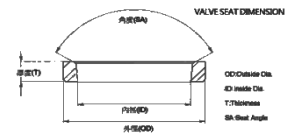

Valve Guide

OEM NO. 13211-V1700
IN/EX 52.0 8.0 12.0

SIZE
STD

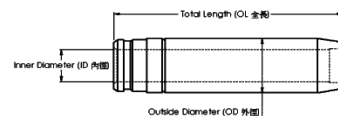

Gasket Set

OEM NO.



NISSAN TD23

Application : TRUCK
Number of Cylinders 4
Cylinder dia. 89.0 MM
Swept Volume 2289 ccm

Piston kit-Set

OEM NO. 12010-02N16/12010-02N06

Piston	SIZE
Comp : 48.3 Height : -2.0 Length : 84.0 Top Shape : Flower Pin : 26.0 Length : 74.0	STD 0.50

Piston Ring

OEM NO. 12033-02N00
NPR : SDN31-037ZZ

OEM Ring Groove	SIZE
Top : 2.5 2nd : 2.0 Oil : 4.0	STD



Cylinder Liner

OEM NO. 11012-02N10

Liner&Sleeve	SIZE
In Diameter : 89.0 Out Diameter : 92.0 Total length : 160.0 Flange : 98.0*5.0 Semi/Finish	STD



Engine Bearing

MAIN : 12207-43G00
CON.ROD : 12111-02N00
T/W : 12280-37525
C/B : 13302-43G00
BUSH : 12030-02N00

SIZE
STD



Engine Valve

OEM NO. 13201-02N00
IN 40.0 8.0 117.0
OEM NO. 13202-02N01
EX 35.0 8.0 117.0

SIZE
STD

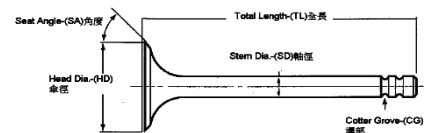

Valve Seat

OEM NO.
IN
OEM NO.
EX

SIZE
STD

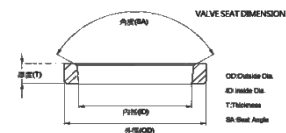

Valve Guide

OEM NO. 13212-43G01
IN/EX 47.0 8.0 12.0

SIZE
STD

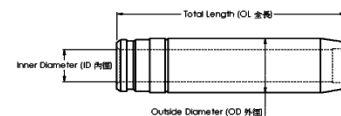

Gasket Set

OEM NO.



NISSAN TD25

Application : TRUCK
Number of Cylinders 4
Cylinder dia. 92.9 MM
Swept Volume 2494ccm

Piston kit-Set

OEM NO. 12010-44G01



Piston

SIZE

Comp : 50.5 Height : -1.7 Length : 87.2

Top Shape : Flower

STD
0.50

Pin : 28.0 Length : 80.0

Piston Ring

OEM NO. 12033-44G10

NPR : SDN31-038ZZ



OEM Ring Groove

SIZE

Top : 2.5

2nd : 2.0

Oil : 4.0

STD

Cylinder Liner

OEM NO. 11012-44G10



Liner&Sleeve

SIZE

In Diameter : 92.9

Out Diameter : 95.9

Total length : 160.0

Flange : 102.0*5.0 Semi/Finish

STD

Engine Bearing

MAIN : 12207-43G00

CON.ROD : 12111-43G00

T/W : 12280-37525

C/B : 13002-43G00

BUSH : 12030-43G00

SIZE

STD



Engine Valve

OEM NO. 13201-44G00

IN 41.5 8.0 117.1

OEM NO. 13202-44G00

EX 37.0 8.0 117.1

SIZE

STD

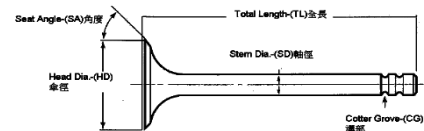

Valve Seat

OEM NO.

IN

OEM NO.

EX

SIZE

STD

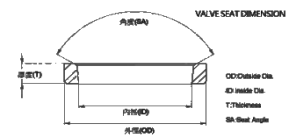

Valve Guide

OEM NO. 13212-43G01

IN/EX 47.0 8.0 12.0

SIZE

STD

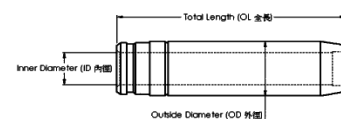

Gasket Set

OEM NO.



NISSAN TD25

Application : TRUCK
Number of Cylinders 4
Cylinder dia. 92.9 MM
Swept Volume 2494ccm

Piston kit-Set

OEM NO. 12010-44G02



Piston	SIZE
Comp : 50.3 w/al-fin Height : -1.7 Length : 87.0 Top Shape : Flower Pin : 28.0 Length : 80.0	STD 0.50

Piston Ring

OEM NO. 12033-44G10
NPR : SDN31-038ZZ



OEM Ring Groove	SIZE
Top : 2.5 2nd : 2.0 Oil : 4.0	STD

Cylinder Liner

OEM NO. 11012-44G10



Liner&Sleeve	SIZE
In Diameter : 92.9 Out Diameter : 95.9 Total length : 160.0 Flange : 102.0*5.0 Semi/Finish	STD

Engine Bearing

MAIN : 12207-43G00
CON.ROD : 12111-43G00
T/W : 12280-37525
C/B : 13002-43G00
BUSH : 12030-43G00



	SIZE
	STD

Engine Valve

OEM NO. 13201-44G00
IN 41.5 8.0 117.1
OEM NO. 13202-44G00
EX 37.0 8.0 117.1

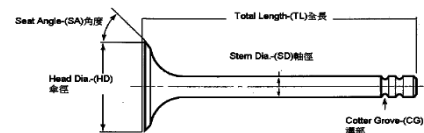

	SIZE
	STD

Valve Seat

OEM NO.
IN
OEM NO.
EX

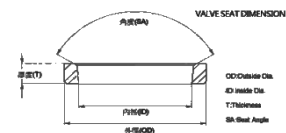

	SIZE
	STD

Valve Guide

OEM NO. 13212-43G01
IN/EX 47.0 8.0 12.0

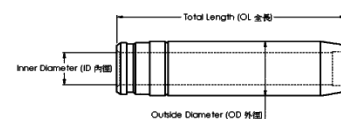

	SIZE
	STD

Gasket Set

OEM NO.



NISSAN TD25

Application : TRUCK
Number of Cylinders 4
Cylinder dia. 92.9 MM
Swept Volume 2494ccm

Piston kit-Set

OEM NO. 12010-44G15



Piston

SIZE

Comp : 50.4 w/al-fin Height : -1.8 Length : 86.0
Top Shape : Flower

STD
0.50

Pin : 30.0 Length : 74.0

Piston Ring

OEM NO. 12033-44G10

NPR : SDN31-038ZZ



OEM Ring Groove

SIZE

Top : 2.5
2nd : 2.0
Oil : 4.0

STD

Cylinder Liner

OEM NO. 11012-44G10



Liner&Sleeve

SIZE

In Diameter : 92.9
Out Diameter : 95.9
Total length : 160.0
Flange : 102.0*5.0 Semi/Finish

STD

Engine Bearing

MAIN : 12207-43G00
CON.ROD : 12111-43G00
T/W : 12280-37525
C/B : 13002-43G00
BUSH : 12030-43G00



SIZE

STD

Engine Valve

OEM NO. 13201-44G00
IN 41.5 8.0 117.1
OEM NO. 13202-44G00
EX 37.0 8.0 117.1

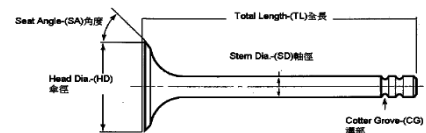

SIZE

STD

Valve Seat

OEM NO.
IN
OEM NO.
EX

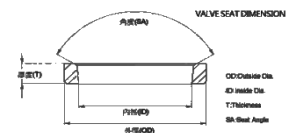

SIZE

STD

Valve Guide

OEM NO. 13212-43G01
IN/EX 47.0 8.0 12.0

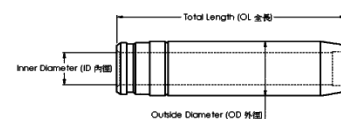

SIZE

STD

Gasket Set

OEM NO.



NISSAN TD25T

Application : TRUCK
Number of Cylinders 4
Cylinder dia. 92.9 MM
Swept Volume 2494ccm

Piston kit-Set

OEM NO. 12010-3S900



Piston

SIZE

Comp : 50.5 w/al-fin Height : -1.5 oil-cooled Length : 86.0
Top Shape : Flower
Head Anodized
Pin : 30.0 Length : 80.0

STD
0.50

Piston Ring

OEM NO.
NPR :



OEM Ring Groove

SIZE

Top : 2.5K
2nd : 2.0
Oil : 3.0

STD

Cylinder Liner

OEM NO. 11012-44G10



Liner&Sleeve

SIZE

In Diameter : 92.9
Out Diameter : 95.9
Total length : 160.0
Flange : 102.0*5.0 Semi/Finish

STD

Engine Bearing

MAIN : 12207-43G00
CON.ROD : 12111-43G00
T/W : 12280-37525
C/B : 13002-43G00
BUSH : 12030-43G00



SIZE

STD

Engine Valve

OEM NO. 13201-44G00
IN 41.5 8.0 117.1
OEM NO. 13202-44G00
EX 37.0 8.0 117.1

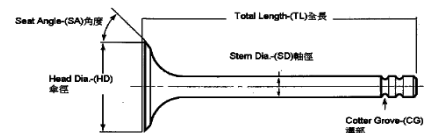

SIZE

STD

Valve Seat

OEM NO.
IN
OEM NO.
EX

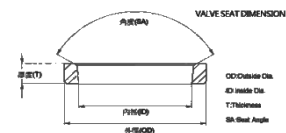

SIZE

STD

Valve Guide

OEM NO. 13212-43G01
IN/EX 47.0 8.0 12.0

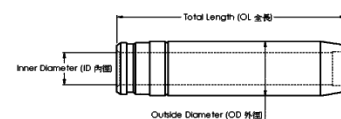

SIZE

STD

Gasket Set

OEM NO.



NISSAN TD27

Application : TRUCK
Number of Cylinders 4
Cylinder dia. 96.0 MM
Swept Volume 2663 ccm

Piston kit-Set

OEM NO. 12010-10T12/12010-43G02

Piston

SIZE

Comp : 50.3 w/al-fin Height : -1.8 Length : 87.1
Top Shape : Flower
Pin : 28.0 Length : 80.0

STD



Piston Ring

OEM NO. 12033-43G10
NPR : SDN31-035ZZ

OEM Ring Groove

SIZE

Top : 2.5
2nd : 2.0
Oil : 4.0

STD



Cylinder Liner

OEM NO. 11012-43G10

Liner&Sleeve

SIZE

In Diameter : 96.0
Out Diameter : 99.0
Total length : 160.0
Flange : 105.0*5.0 Semi/Finish

STD



Engine Bearing

MAIN : 12207-43G00
CON.ROD : 12111-43G00
T/W : 12280-37525
C/B : 13002-43G00
BUSH : 12030-43G00

SIZE

STD



Engine Valve

OEM NO. 13201-43G00/01
IN 43.5 8.0 117.0
OEM NO. 13202-43G01
EX 38.0 8.0 117.0

SIZE

STD

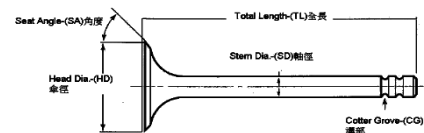

Valve Seat

OEM NO. 11098-54T01
IN 44.5 38.0 7.0
OEM NO. 11099-43G00
EX 39.5 33.0 8.0

SIZE

STD

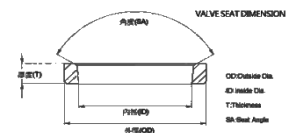

Valve Guide

OEM NO. 13212-43G01
IN/EX 47.0 8.0 12.0

SIZE

STD

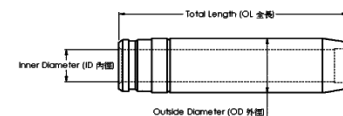

Gasket Set

OEM NO.



NISSAN TD27T-A11

Application : TRUCK
Number of Cylinders 4
Cylinder dia. 96.0 MM
Swept Volume 2663 ccm

Piston kit-Set

OEM NO. 12010-31N03/12010-31N02

Piston	SIZE
Comp : 50.3 w/al-fin Height : -1.7 oil-cooled Length : 86.0 Top Shape : Flower Head Anodized Pin : 30.0 Length : 80.0	STD



Piston Ring

OEM Ring Groove	SIZE
Top : 2.5K 2nd : 2.0 Oil : 4.0	STD



Cylinder Liner

Liner&Sleeve	SIZE
In Diameter : 96.0 Out Diameter : 99.0 Total length : 160.0 Flange : 105.0*5.0 Semi/Finish	STD



Engine Bearing

	SIZE
MAIN : 12207-43G00 CON.ROD : 12111-43G00 T/W : 12280-37525 C/B : 13002-43G00 BUSH : 12030-43G00	STD



Engine Valve

	SIZE
OEM NO. 13201-43G00/01 IN 43.5 8.0 117.0 OEM NO. 13202-43G01 EX 38.0 8.0 117.0	STD

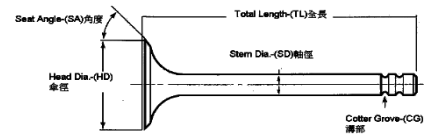

Valve Seat

	SIZE
OEM NO. 11098-54T01 IN 44.5 38.0 7.0 OEM NO. 11099-43G00 EX 39.5 33.0 8.0	STD

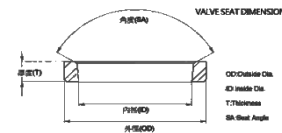

Valve Guide

	SIZE
OEM NO. 13212-43G01 IN/EX 47.0 8.0 12.0	STD

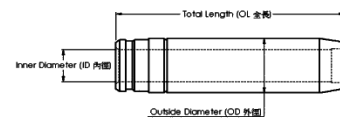

Gasket Set

OEM NO.	
---------	--



NISSAN TD27T

Application : TRUCK
Number of Cylinders 4
Cylinder dia. 96.0 MM
Swept Volume 2663 ccm

Piston kit-Set

OEM NO. A2010-9C626



Piston

SIZE

Comp : 50.7 w/al-fin Height : -2.0 oil-cooled
Length : 74.0 mos2 Top Shape : Flower
Head Anodized
Pin : 30.0 Length : 79.6

STD

Piston Ring

OEM NO. 12033-2W211
NPR : SDN30-153ZZ



OEM Ring Groove

SIZE

Top : 2.5K
2nd : 2.0
Oil : 4.0

STD

Cylinder Liner

OEM NO. 11012-43G10



Liner&Sleeve

SIZE

In Diameter : 96.0
Out Diameter : 99.0
Total length : 160.0
Flange : 105.0*5.0 Semi/Finish

STD

Engine Bearing

MAIN : 12207-43G00
CON.ROD : 12111-43G00
T/W : 12280-37525
C/B : 13002-43G00
BUSH : 12030-43G00



SIZE

STD

Engine Valve

OEM NO. 13201-43G00/01
IN 43.5 8.0 117.0
OEM NO. 13202-43G01
EX 38.0 8.0 117.0

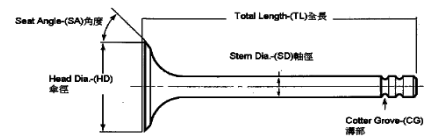

SIZE

STD

Valve Seat

OEM NO. 11098-54T01
IN 44.5 38.0 7.0
OEM NO. 11099-43G00
EX 39.5 33.0 8.0

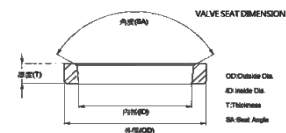

SIZE

STD

Valve Guide

OEM NO. 13212-43G01
IN/EX 47.0 8.0 12.0

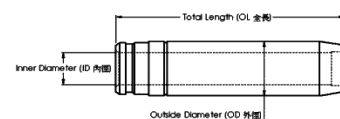

SIZE

STD

Gasket Set

OEM NO.



Piston kit-Set

OEM NO. 12010-0W820

Piston	SIZE
Comp : 50.5 w/al-fin Height : -1.6 oil-cooled Length : 87.3 MOS2 Top Shape : Flower Head Anodized Pin : 30.0 Length : 80.0	STD



Piston Ring

OEM NO. 12033-2W211
NPR : SDN30-153ZZ

OEM Ring Groove	SIZE
Top : 2.5HK 2nd : 2.0 Oil : 3.0	STD



Cylinder Liner

OEM NO. 11012-43G10

Liner&Sleeve	SIZE
In Diameter : 96.0 Out Diameter : 99.0 Total length : 160.0 Flange : 105.0*5.0 Semi/Finish	STD



Engine Bearing

MAIN : 12207-43G00
CON.ROD : 12111-43G00
T/W : 12280-37525
C/B : 13002-43G00
BUSH : 12030-43G00

SIZE
STD



Engine Valve

OEM NO. 13201-43G00/01
IN 43.5 8.0 117.0
OEM NO. 13202-43G01
EX 38.0 8.0 117.0

SIZE
STD

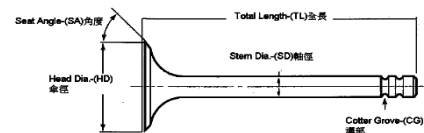

Valve Seat

OEM NO. 11098-54T01
IN 44.5 38.0 7.0
OEM NO. 11099-43G00
EX 39.5 33.0 8.0

SIZE
STD

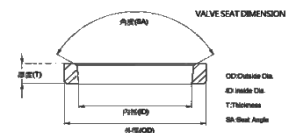

Valve Guide

OEM NO. 13212-43G01
IN/EX 47.0 8.0 12.0

SIZE
STD

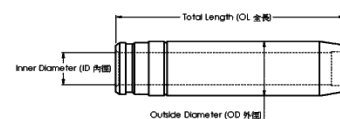

Gasket Set

OEM NO.



NISSAN TD27T-D1

Application : TRUCK
Number of Cylinders 4
Cylinder dia. 96.0 MM
Swept Volume 2663 ccm

Piston kit-Set

OEM NO. 12011-31N03

Piston	SIZE
Comp : 50.3 w/al-fin Height : -1.9 Length : 87.0 Top Shape : Flower Pin : 30.0 Length : 80.0	STD



Piston Ring

OEM NO. 12033-37N10
NPR : SDN30-147ZZ

OEM Ring Groove	SIZE
Top : 2.5K 2nd : 2.0 Oil : 4.0	STD



Cylinder Liner

OEM NO. 11012-43G10

Liner&Sleeve	SIZE
In Diameter : 96.0 Out Diameter : 99.0 Total length : 160.0 Flange : 105.0*5.0 Semi/Finish	STD



Engine Bearing

MAIN : 12207-43G00
CON.ROD : 12111-43G00
T/W : 12280-37525
C/B : 13002-43G00
BUSH : 12030-43G00

SIZE
STD



Engine Valve

OEM NO. 13201-43G00/01
IN 43.5 8.0 117.0
OEM NO. 13202-43G01
EX 38.0 8.0 117.0

SIZE
STD

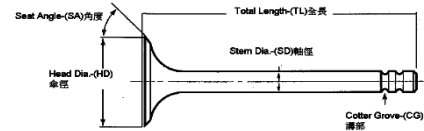

Valve Seat

OEM NO. 11098-54T01
IN 44.5 38.0 7.0
OEM NO. 11099-43G00
EX 39.5 33.0 8.0

SIZE
STD

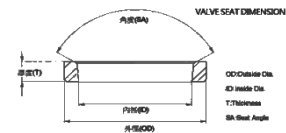

Valve Guide

OEM NO. 13212-43G01
IN/EX 47.0 8.0 12.0

SIZE
STD

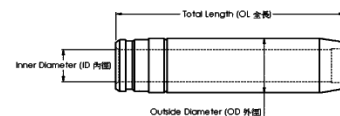

Gasket Set

OEM NO.



NISSAN TD27T-H1

Application : TRUCK
Number of Cylinders 4
Cylinder dia. 96.0 MM
Swept Volume 2663 ccm

Piston kit-Set

OEM NO. 12010-6T000

Piston	SIZE
Comp : 50.3 w/al-fin Height : -1.9 Length : 87.0 Top Shape : Flower Pin : 30.0 Length : 80.0	STD



Piston Ring

OEM NO. 12033-6T101
NPR : SDN31-056ZZ

OEM Ring Groove	SIZE
Top : 2.5 2nd : 2.0 Oil : 3.0	STD



Cylinder Liner

OEM NO. 11012-43G10

Liner&Sleeve	SIZE
In Diameter : 96.0 Out Diameter : 99.0 Total length : 160.0 Flange : 105.0*5.0 Semi/Finish	STD



Engine Bearing

MAIN : 12207-43G00
CON.ROD : 12111-43G00
T/W : 12280-37525
C/B : 13002-43G00
BUSH : 12030-43G00

SIZE
STD



Engine Valve

OEM NO. 13201-43G00/01
IN 43.5 8.0 117.0
OEM NO. 13202-43G01
EX 38.0 8.0 117.0

SIZE
STD

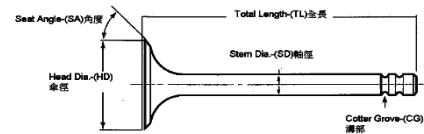

Valve Seat

OEM NO. 11098-54T01
IN 44.5 38.0 7.0
OEM NO. 11099-43G00
EX 39.5 33.0 8.0

SIZE
STD

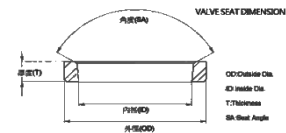

Valve Guide

OEM NO. 13212-43G01
IN/EX 47.0 8.0 12.0

SIZE
STD

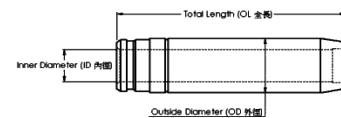

Gasket Set

OEM NO.



NISSAN TD27T-H2

Application : TRUCK
Number of Cylinders 4
Cylinder dia. 96.0 MM
Swept Volume 2663 ccm

Piston kit-Set

OEM NO. 12010-10T05



Piston

SIZE

Comp : 50.3 w/al-fin Height : -1.7 Length : 86.0
Top Shape : Flower
Pin : 30.0
Length : 74.0

STD

Piston Ring

OEM NO. 12033-6T101

NPR : SDN31-056ZZ

OEM Ring Groove

SIZE

Top : 2.5
2nd : 2.0
Oil : 3.0

STD



Cylinder Liner

OEM NO. 11012-43G10

Liner&Sleeve

SIZE

In Diameter : 96.0
Out Diameter : 99.0
Total length : 160.0
Flange : 105.0*5.0 Semi/Finish

STD



Engine Bearing

MAIN : 12207-43G00
CON.ROD : 12111-43G00
T/W : 12280-37525
C/B : 13002-43G00
BUSH : 12030-43G00

SIZE

STD



Engine Valve

OEM NO. 13201-43G00/01
IN 43.5 8.0 117.0
OEM NO. 13202-43G01
EX 38.0 8.0 117.0

SIZE

STD

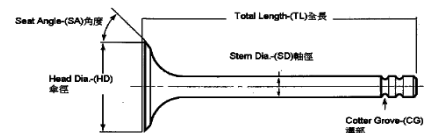

Valve Seat

OEM NO. 11098-54T01
IN 44.5 38.0 7.0
OEM NO. 11099-43G00
EX 39.5 33.0 8.0

SIZE

STD

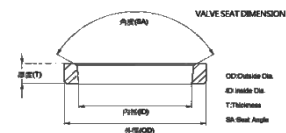

Valve Guide

OEM NO. 13212-43G01
IN/EX 47.0 8.0 12.0

SIZE

STD

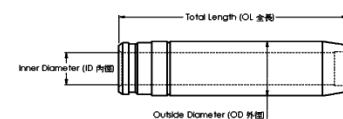

Gasket Set

OEM NO.



NISSAN TD42

Application : TRUCK
Number of Cylinders 4
Cylinder dia. 96.0 MM
Swept Volume 4169 ccm

Piston kit-Set

OEM NO. 12010-05D11



Piston	SIZE
Comp : 50.6 w/al-fin Height : -1.75 oil-cooled Length : 87.1 Top Shape : Flower Pin : 30.0 Length : 80.0	STD

Piston Ring

OEM NO.
NPR :



OEM Ring Groove	SIZE
Top : 2.5HK 2nd : 2.0 Oil : 3.0	STD

Cylinder Liner

OEM NO. 11012-43G10



Liner&Sleeve	SIZE
In Diameter : 96.0 Out Diameter : 99.0 Total length : 160.0 Flange : 105.0*5.0 Semi/Finish	STD

Engine Bearing

MAIN : 12207-06J10
CON.ROD : 12111-43G00
T/W : 12280-37525
C/B :
BUSH : 12030-43G00



	SIZE
	STD

Engine Valve

OEM NO. 13201-43G00/01
IN 43.5 8.0 117.0
OEM NO. 13202-43G01
EX 38.0 8.0 117.0

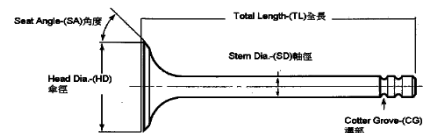

	SIZE
	STD

Valve Seat

OEM NO. 11098-54T01
IN 44.5 38.0 7.0
OEM NO. 11099-43G00
EX 39.5 33.0 8.0

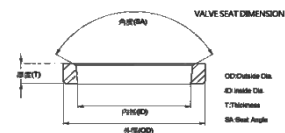

	SIZE
	STD

Valve Guide

OEM NO. 13212-43G01
IN/EX 47.0 8.0 12.0

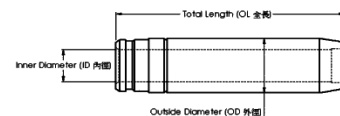

	SIZE
	STD

Gasket Set

OEM NO.



NISSAN TD42

Application : TRUCK
 Number of Cylinders 4
 Cylinder dia. 96.0 MM
 Swept Volume 4169 ccm

Piston kit-Set

OEM NO. 12010-09D12



Piston

SIZE

Comp : 50.2 w/al-fin Height : -1.6 oil-cooled Length : 87.1
 Top Shape : Flower
 Pin : 30.0
 Length : 80.0

STD

Piston Ring

OEM NO.
 NPR :



OEM Ring Groove

SIZE

Top : 2.5HK
 2nd : 2.0
 Oil : 3.0

STD

Cylinder Liner

OEM NO. 11012-43G10



Liner&Sleeve

SIZE

In Diameter : 96.0
 Out Diameter : 99.0
 Total length : 160.0
 Flange : 105.0*5.0 Semi/Finish

STD

Engine Bearing

MAIN : 12207-06J10
 CON.ROD : 12111-43G00
 T/W : 12280-37525
 C/B :
 BUSH : 12030-43G00

SIZE



STD

Engine Valve

OEM NO. 13201-43G00/01
 IN 43.5 8.0 117.0
 OEM NO. 13202-43G01
 EX 38.0 8.0 117.0

SIZE

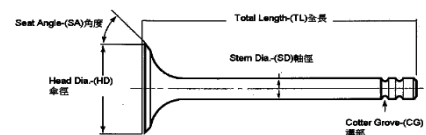

STD

Valve Seat

OEM NO. 11098-54T01
 IN 44.5 38.0 7.0
 OEM NO. 11099-43G00
 EX 39.5 33.0 8.0

SIZE

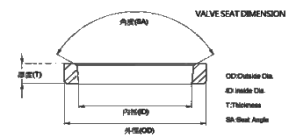

STD

Valve Guide

OEM NO. 13212-43G01
 IN/EX 47.0 8.0 12.0

SIZE

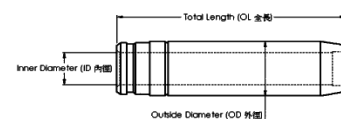

STD

Gasket Set

OEM NO.



NISSAN

UD3

Application : TRUCK
Number of Cylinders 4
Cylinder dia. 110.0 MM
Swept Volume 3076 ccm

Piston kit-Set

OEM NO. 13211-2700

Piston

SIZE

Comp : 90.0 Cast iron Height : Length : 155.0
 Top Shape : Ø90.0
 Direct Injection
 Pin : 38.0 Length :

STD

Piston Ring

OEM NO. 12040-90008

NPR : SDN31-005ZZ

OEM Ring Groove

SIZE

Top : 3.0
 2nd : 3.0
 3nd : 3.0
 4nd : 3.0
 Oil : 4.8

STD



Cylinder Liner

OEM NO. 11012-90006

Liner&Sleeve

SIZE

In Diameter : 110.0
 Out Diameter : 126.0
 Total length : 281.5
 Flange : 136.0*8.0+1.5

STD



Engine Bearing

MAIN :
 CON.ROD :
 T/W :
 C/B :
 BUSH :

SIZE

STD



Engine Valve

OEM NO. 13201-NA003
 IN 46.7 10.0 196.0
 OEM NO. 13202-NA002
 EX 45.9 10.0 194.8

SIZE

STD

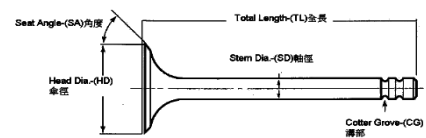

Valve Seat

OEM NO.
 IN
 OEM NO.
 EX

SIZE

STD

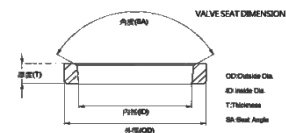

Valve Guide

OEM NO. 13211-90000
 IN/EX 91.0 10.0 15.0

SIZE

STD

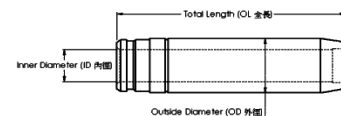

Gasket Set

OEM NO.



NISSAN

UD3

Application : TRUCK
Number of Cylinders 4
Cylinder dia. 110.0 MM
Swept Volume 3076 ccm

Piston kit-Set

OEM NO. 13211-2700

Piston

SIZE

Comp : 90.0 Cast iron Height : Length : 155.0
 Top Shape : Ø90.0
 Direct Injection
 Pin : 38.0 Length :

STD

Piston Ring

OEM NO. 12040-90008

NPR : SDN31-005ZZ

OEM Ring Groove

SIZE

Top : 3.0
 2nd : 3.0
 3nd : 3.0
 4nd : 3.0
 Oil : 4.8

STD



Cylinder Liner

OEM NO. 11012-90006

Liner&Sleeve

SIZE

In Diameter : 110.0
 Out Diameter : 126.0
 Total length : 281.5
 Flange : 136.0*8.0+1.5

STD



Engine Bearing

MAIN :
 CON.ROD :
 T/W :
 C/B :
 BUSH :

SIZE

STD



Engine Valve

OEM NO. 13201-NA003
 IN 46.7 10.0 196.0
 OEM NO. 13202-NA002
 EX 45.9 10.0 194.8

SIZE

STD

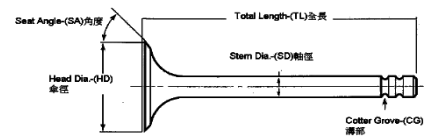

Valve Seat

OEM NO.
 IN
 OEM NO.
 EX

SIZE

STD

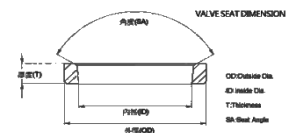

Valve Guide

OEM NO. 13211-90000
 IN/EX 91.0 10.0 15.0

SIZE

STD

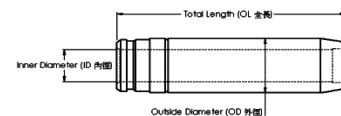

Gasket Set

OEM NO.



NISSAN YD22D DT

Application :
Number of Cylinders 4
Cylinder dia. 86.0 MM
Swept Volume 2200 ccm

Piston kit-Set

OEM NO. A2010-8H800

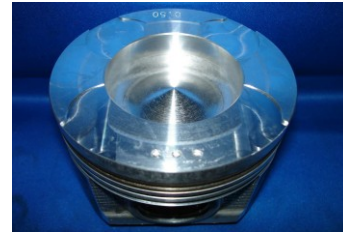

Piston	SIZE
Comp : 49.0 w/al-fin Height : -16.0 oil-cooled Length : 80.0 MOS2 Top Shape : Ø48.0 Direct Injection Pin : 28.0 Length : 61.5	STD 0.50

Piston Ring

OEM NO. 12033-AW400
NPR : SDN30-180ZZ



OEM Ring Groove	SIZE
Top : 2.0K 2nd : 2.0 Oil : 3.0	STD 0.50

Cylinder Liner

OEM NO.



Liner&Sleeve	SIZE
In Diameter : Out Diameter : Total length : Flange :	STD

Engine Bearing

MAIN :
CON.ROD :
T/W :
C/B :
BUSH :



	SIZE
	STD

Engine Valve

OEM NO. 13201-AD210
IN 28.0 6.0 106.7
OEM NO. 13202-AD200
EX 26.0 6.0 106.3

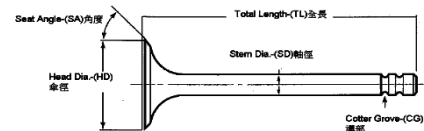

	SIZE
	STD

Valve Seat

OEM NO.
IN
OEM NO.
EX

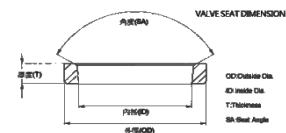

	SIZE
	STD

Valve Guide

OEM NO. 13212-AD260
IN 59.8 6.0 10.0
OEM NO. 13213-AD260
EX 44.2 6.0 10.0

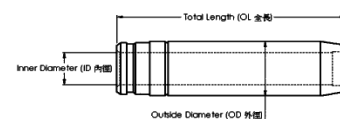

	SIZE
	STD

Gasket Set

OEM NO.



NISSAN YD22D DT

Application :
Number of Cylinders 4
Cylinder dia. 86.0 MM
Swept Volume 2200 ccm

Piston kit-Set

OEM NO. A2010-AU165

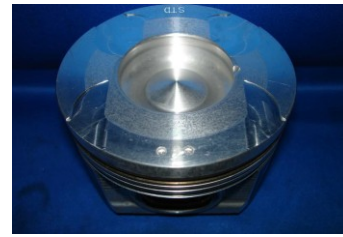

Piston	SIZE
Comp : 49.0 w/al-fin Height : -16.1 oil-cooled Length : 80.2 MOS2 Top Shape : Ø41.3 Direct Injection Pin : 28.0 Length : 60.0	STD 0.50

Piston Ring

OEM NO. 12033-AW400
NPR : SDN30-180ZZ



OEM Ring Groove	SIZE
Top : 2.0K 2nd : 2.0 Oil : 3.0	STD 0.50

Cylinder Liner

OEM NO.



Liner&Sleeve	SIZE
In Diameter : Out Diameter : Total length : Flange :	STD

Engine Bearing

MAIN :
CON.ROD :
T/W :
C/B :
BUSH :



	SIZE
	STD

Engine Valve

OEM NO. 13201-AD210
IN 28.0 6.0 106.7
OEM NO. 13202-AD200
EX 26.0 6.0 106.3

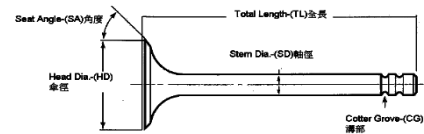

	SIZE
	STD

Valve Seat

OEM NO.
IN
OEM NO.
EX

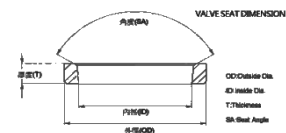

	SIZE
	STD

Valve Guide

OEM NO. 13212-AD260
IN 59.8 6.0 10.0
OEM NO. 13213-AD260
EX 44.2 6.0 10.0

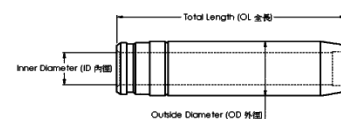

	SIZE
	STD

Gasket Set

OEM NO.



NISSAN YD22D DT

Application :
Number of Cylinders 4
Cylinder dia. 86.0 MM
Swept Volume 2200 ccm

Piston kit-Set

OEM NO. A2010-AW400

Piston	SIZE
Comp : 49.0 w/al-fin Height : -15.1 oil-cooled Length : 74.0 MOS2 Top Shape : Ø48.8 Direct Injection Pin : 28.0 Length : 69.0	STD 0.50

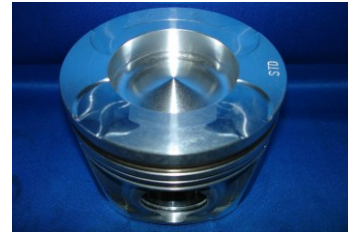

Piston Ring

OEM NO. 12033-AW400
NPR : SDN30-180ZZ

OEM Ring Groove	SIZE
Top : 2.0K 2nd : 2.0 Oil : 3.0	STD 0.50



Cylinder Liner

OEM NO.

Liner&Sleeve	SIZE
In Diameter : Out Diameter : Total length : Flange :	STD



Engine Bearing

MAIN :	SIZE
CON.ROD : T/W : C/B : BUSH :	STD



Engine Valve

OEM NO. 13201-AD210 IN 28.0 6.0 106.7 OEM NO. 13202-AD200 EX 26.0 6.0 106.3	SIZE
	STD

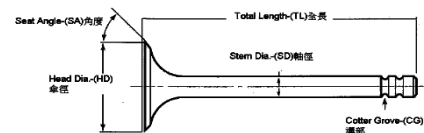

Valve Seat

OEM NO. IN OEM NO. EX	SIZE
	STD

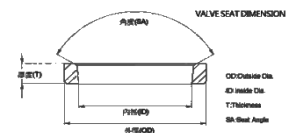

Valve Guide

OEM NO. 13212-AD260 IN 59.8 6.0 10.0 OEM NO. 13213-AD260 EX 44.2 6.0 10.0	SIZE
	STD

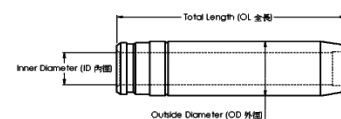

Gasket Set

OEM NO.



NISSAN YD25D DTI

Application : TRUCK
Number of Cylinders 4
Cylinder dia. 89.0 MM
Swept Volume 2488 ccm

Piston kit-Set

OEM NO. 12010-EC00B

Piston	SIZE
Comp : 49.0 w/al-fin Height : -17.2 oil-cooled Length : 74.0 MOS2 Top Shape : Ø47.5 Direct Injection Pin : 28.0 Length : 71.0	STD 0.50

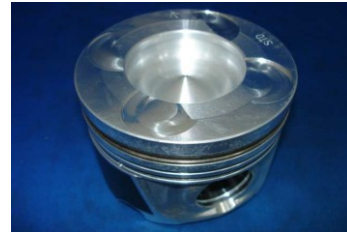

Piston Ring

OEM NO. 12033-EB300
NPR :

OEM Ring Groove	SIZE
Top : 2.0K 2nd : 2.0 Oil : 3.0	STD 0.50



Cylinder Liner

OEM NO.

Liner&Sleeve	SIZE
In Diameter : Out Diameter : Total length : Flange :	STD



Engine Bearing

MAIN : CON.ROD : T/W : C/B : BUSH :	SIZE
	STD



Engine Valve

OEM NO. 13201-AD210 IN 28.0 6.0 106.7 OEM NO. 13202-AD200 EX 26.0 6.0 106.3	SIZE
	STD

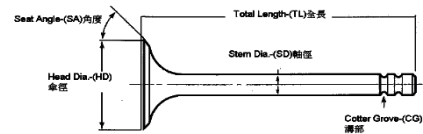

Valve Seat

OEM NO. IN OEM NO. EX	SIZE
	STD

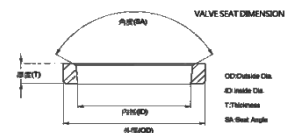

Valve Guide

OEM NO. 13212-AD260 IN 59.8 6.0 10.0 OEM NO. 13213-AD260 EX 44.2 6.0 10.0	SIZE
	STD

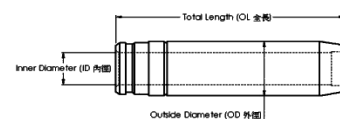

Gasket Set

OEM NO.



NISSAN YD25D DTI

Application : TRUCK
Number of Cylinders 4
Cylinder dia. 89.0 MM
Swept Volume 2488 ccm

Piston kit-Set

OEM NO. A2010-EB30A

Piston	SIZE
Comp : 48.9 w/al-fin Height : -19.2 oil-cooled Length : 73.8 MOS2 Top Shape : Ø Direct Injection Pin : 28.0 Length : 71.0	STD

Piston Ring

OEM NO. 12033-EB300
NPR :

OEM Ring Groove	SIZE
Top : 2.0K 2nd : 2.0 Oil : 3.0	STD



Cylinder Liner

OEM NO.

Liner&Sleeve	SIZE
In Diameter : Out Diameter : Total length : Flange :	STD



Engine Bearing

MAIN :	SIZE
CON.ROD : T/W : C/B : BUSH :	STD



Engine Valve

OEM NO. 13201-AD210 IN 28.0 6.0 106.7 OEM NO. 13202-AD200 EX 26.0 6.0 106.3	SIZE
	STD

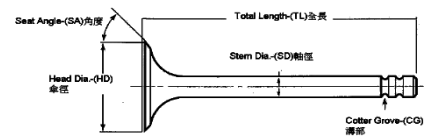

Valve Seat

OEM NO. IN OEM NO. EX	SIZE
	STD

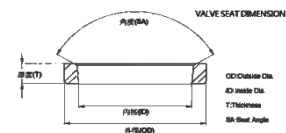

Valve Guide

OEM NO. 13212-AD260 IN 59.8 6.0 10.0 OEM NO. 13213-AD260 EX 44.2 6.0 10.0	SIZE
	STD

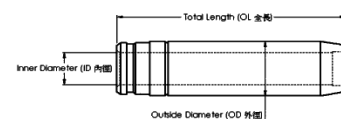

Gasket Set

OEM NO.



NISSAN YD25D DTI

Application : TRUCK
Number of Cylinders 4
Cylinder dia. 89.0 MM
Swept Volume 2488 ccm

Piston kit-Set

OEM NO. A2010-EB30A

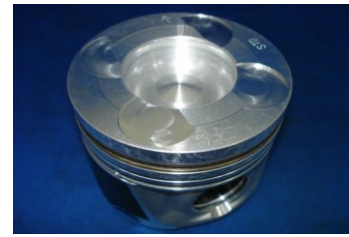

Piston	SIZE
Comp : 48.9 w/al-fin Height : -19.0 oil-cooled Length : 80.0 MOS2 Top Shape : Ø44.5 Direct Injection Pin : 28.0 Length : 71.0	STD 0.50

Piston Ring

OEM NO. 12033-VK500
NPR :



OEM Ring Groove	SIZE
Top : 2.0K 2nd : 2.0 Oil : 3.0	STD 0.50

Cylinder Liner

OEM NO.



Liner&Sleeve	SIZE
In Diameter : Out Diameter : Total length : Flange :	STD

Engine Bearing

MAIN :
CON.ROD :
T/W :
C/B :
BUSH :



	SIZE
	STD

Engine Valve

OEM NO. 13201-AD210
IN 28.0 6.0 106.7
OEM NO. 13202-AD200
EX 26.0 6.0 106.3

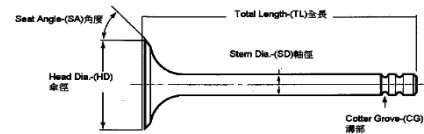

	SIZE
	STD

Valve Seat

OEM NO.
IN
OEM NO.
EX

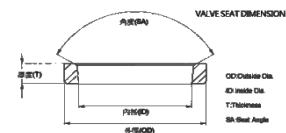

	SIZE
	STD

Valve Guide

OEM NO. 13212-AD260
IN 59.8 6.0 10.0
OEM NO. 13213-AD260
EX 44.2 6.0 10.0

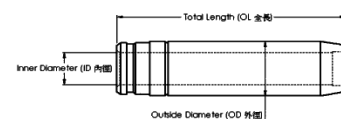

	SIZE
	STD

Gasket Set

OEM NO.



NISSAN YD25D DTI

Application : TRUCK
Number of Cylinders 4
Cylinder dia. 89.0 MM
Swept Volume 2488 ccm

Piston kit-Set

OEM NO. A2010-VK510

Piston	SIZE
Comp : 48.8 w/al-fin Height : -18.0 oil-cooled Length : 80.0 Top Shape : Ø Direct Injection Pin : 28.0 Length : 61.0	STD

Piston Ring

OEM NO. 12033-VK500
NPR :

OEM Ring Groove	SIZE
Top : 2.0K 2nd : 2.0 Oil : 3.0	STD



Cylinder Liner

OEM NO.

Liner&Sleeve	SIZE
In Diameter : Out Diameter : Total length : Flange :	STD



Engine Bearing

MAIN : CON.ROD : T/W : C/B : BUSH :	SIZE
	STD



Engine Valve

OEM NO. 13201-AD210 IN 28.0 6.0 106.7 OEM NO. 13202-AD200 EX 26.0 6.0 106.3	SIZE
	STD

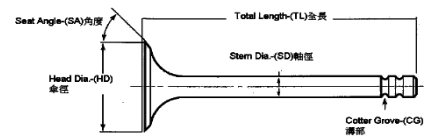

Valve Seat

OEM NO. IN OEM NO. EX	SIZE
	STD

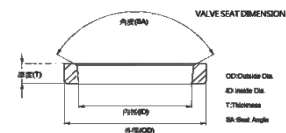

Valve Guide

OEM NO. 13212-AD260 IN 59.8 6.0 10.0 OEM NO. 13213-AD260 EX 44.2 6.0 10.0	SIZE
	STD

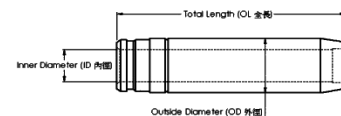

Gasket Set

OEM NO.



NISSAN ZD30TN

Application :
Number of Cylinders 4
Cylinder dia. 96.0 MM
Swept Volume 2953 ccm

Piston kit-Set

OEM NO. 12010-VK600



Piston

SIZE

Comp : 50.1 w/al-fin Height : -19.5 oil-cooled Length : 74.1 Top
 Shape : Ø46.0
 Direct Injection
 Pin : 33.0 Length : 78.0

STD

Piston Ring

OEM NO. 12033-2W211

NPR : SDN30-153ZZ

OEM Ring Groove

SIZE

Top : 2.5K
 2nd : 2.0
 Oil : 3.0

STD



Cylinder Liner

OEM NO.

Liner&Sleeve

SIZE

In Diameter :
 Out Diameter :
 Total length :
 Flange :

STD



Engine Bearing

MAIN :
 CON.ROD :
 T/W :
 C/B :
 BUSH :

SIZE

STD



Engine Valve

OEM NO.
 IN
 OEM NO.
 EX

SIZE

STD

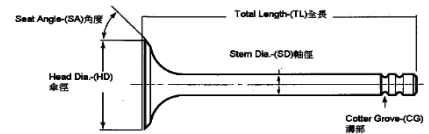

Valve Seat

OEM NO.
 IN
 OEM NO.
 EX

SIZE

STD

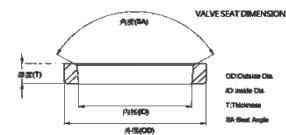

Valve Guide

OEM NO.
 IN
 OEM NO.
 EX

SIZE

STD

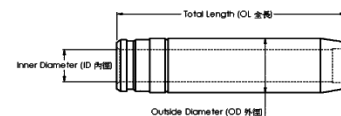

Gasket Set

OEM NO.



NISSAN ZD30TN

Application :
Number of Cylinders 4
Cylinder dia. 96.0 MM
Swept Volume 2953ccm

Piston kit-Set

OEM NO. 12010-VK610

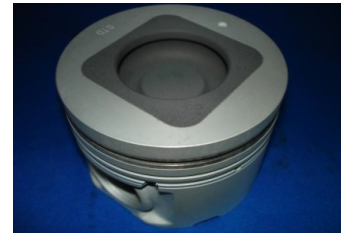

Piston

SIZE

Comp : 50.1 w/al-fin Height : -19.5 oil-cooled Length : 74.1 Top
 Shape : Ø46.4
 Direct Injection
 Pin : 33.0 Length : 78.0

STD

Piston Ring

OEM NO. 12033-VK610

NPR : SDN30-174ZZ



OEM Ring Groove

SIZE

Top : 2.5K
 2nd : 2.0
 Oil : 2.0

STD

Cylinder Liner

OEM NO.



Liner&Sleeve

SIZE

In Diameter :
 Out Diameter :
 Total length :
 Flange :

STD

Engine Bearing

MAIN :
 CON.ROD :
 T/W :
 C/B :
 BUSH :



SIZE

STD

Engine Valve

OEM NO.
 IN
 OEM NO.
 EX

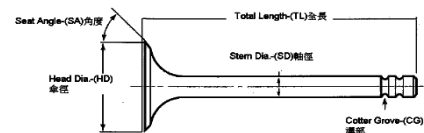

SIZE

STD

Valve Seat

OEM NO.
 IN
 OEM NO.
 EX

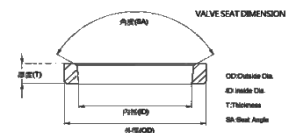

SIZE

STD

Valve Guide

OEM NO.
 IN
 OEM NO.
 EX

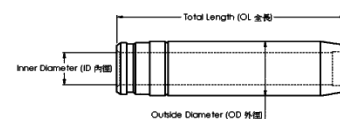

SIZE

STD

Gasket Set

OEM NO.

